

FOR THE  
**AMSTRAD**  
PCW 8256-8512

SAY  
GOODBYE  
TO CP/M



*AMX Desktop – icons for all*

**8000  
PLUS**

ISSUE 8 • MAY 1987 • £1.25

# LocoScript

# 2

**Exclusive review**



Electric Studio Newsdesk review • Full games guide • On-line with modems

# What's so special about the Mac, the Atari St, The Amiga, Windows and Gem?

It's no surprise that nearly all new 16 bit 'state of the art' micros now come with a Mouse and Wimp environment (Windows, Icons, Menus and Pointers) as standard.

With the AMSTRAD PCW you already own one of the classic micros and by simply adding the AMX Mouse and Desktop you can achieve the same ease of use, freedom and versatility of much more sophisticated computers.

The AMX Mouse and compatible software – it's what you and your AMSTRAD micro have been missing.



**AMX MOUSE PACKAGE 3" DISC £79.95**

There's not much joy in a joystick and keyboards can be all fingers and thumbs. Acclaimed by the press as 'the best input device', already over 50,000 micro users have adopted an AMX Mouse. No more complicated CP/M commands to remember, with the AMX Mouse you just point and click, even the experts find this system more efficient. Available for the Amstrad PCW 8256 & 8512.

## GRAPHIC FRONT END



Provides an easy to use graphic based front end to your computers disc filing system including a comprehensive set of disc management operations such as cataloging, copying, deleting, renaming and formatting. There's no need to enter a command to run programs from disc, just point the mouse at the representing icon and click the button.

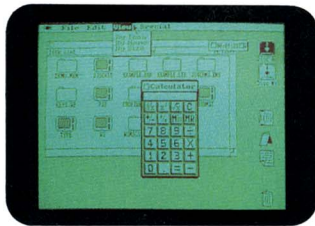

## TELEPHONE ADDRESS BOOK



A central place to store all your important names, addresses and telephone numbers.

A database type search facility allows you to enter any part of the information such as a persons' name, company name, town etc and instantly see the matching entry.



## DESK DIARY



A versatile appointments diary allowing you up to seven lines to be entered for any day. Printing facilities allow yearly and monthly summaries to be produced indicating days for which an entry has been indicated.

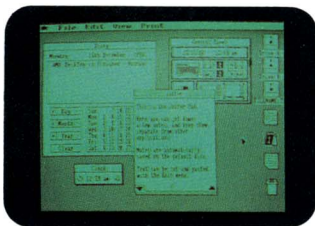

## MEMO PAD



This allows anything from a quick memo to a complete multi-page report to be produced from the Desktop. Many word processing features are included such as centering, justification, cut, copy and paste etc.

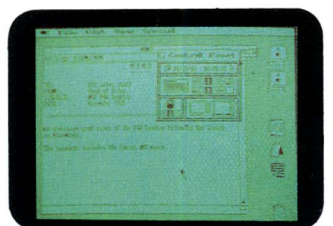

## DESK ACCESSORIES



The AMX Mouse package also includes a number of extra functions which are available for use at all times from the desktop. These include a jotter, alarm clock, calculator, puzzle and control panel – the type of tools found on a real desk top!

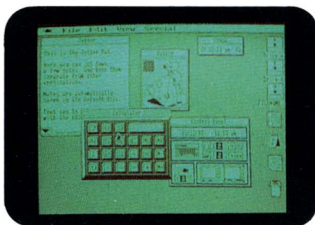

## STOP PRESS... STOP PRESS...

There will be a growing list of further mouse compatible software for the Amstrad PCW from AMS and other leading software houses in the coming months including Graphic and Desktop publishing programs.

This superb product is available now from all good computer dealers or direct by cheque, Access or Visa. All prices include VAT and post and packaging.



FOR INSTANT ACCESS/VISA ORDERS TELEPHONE (0925) 413501/2/3



# AMX SOFTWARE

IMAGINATION AT YOUR FINGERTIPS

ADVANCED MEMORY SYSTEMS LTD. 166/170 WILDERSPOOL CAUSEWAY, WARRINGTON, WA4 6QA. TELEX 628672 AMSG. FAX 0925 58039.

TUBELINK ON PRESTEL PAGE 2582182 SUPPORTS THE AMX MOUSE AND ALL AMS SOFTWARE

Macintosh is a licenced trade mark of Apple Inc. Atari St. is a trade mark of Atari Inc. Amiga is a trade mark of Commodore Business Machines Inc. Windows is a trade mark of Microsoft Inc. Gem is a trade mark of Digital Research Inc.

# 8000 PLUS

FUTURE PUBLISHING LTD  
THE OLD BARN  
SOMERTON  
SOMERSET • TAI 1 7PY  
TEL • 0458 74080

Telecom Gold • 84:TXT152

#### YOUR CONTACTS

EDITOR • SIMON WILLIAMS  
TECHNICAL EDITOR • BEN TAYLOR  
ASSISTANT EDITOR • ALEC RAE  
ADVERTISING • ANNE DEANEY  
AD PRODUCTION • DIANE TAVERNER  
DESIGN • DEAN WILSON  
SUBSCRIPTIONS • CARRIE-ANNE PORTER  
PUBLISHER • CHRIS ANDERSON

COVER PHOTOGRAPHY  
ANTHONY SPINKS ABIPP AMPA  
STUDIO SEVENTY  
BOW STREET • LANGPORT  
SOMERSET  
TEL • 0458 250807

COLOUR ORIGINATION  
WESSEX REPRODUCTION  
352A WELLS ROAD  
BRISTOL • BS4 0QL

PRINTING  
REDWOOD WEB OFFSET  
TEOMANS WAY  
TROWBRIDGE • WILTS

DISTRIBUTION  
SEYMOUR PRESS  
334 Brixton Road  
LONDON • SW9 7AG

© FUTURE PUBLISHING LTD 1987  
8000 Plus is an independent publication. The company who produce it - Future Publishing Ltd - have no link with Amstrad plc.  
We welcome contributions from readers, but unfortunately we cannot guarantee to return material submitted to us, nor can we enter into personal correspondence.  
We take great care to ensure that what we publish is accurate, but we cannot accept liability for any mistakes or misprints. No part of this publication may be reproduced in any form without our permission.

# OPENING MENU

## OPENING MENU

AmazING News  
StunninG Features  
kNockout Reviews  
InValuable Tips  
SiZzling Offers

### 5 KEY WORDS

Editor's ideas and other wizard wheezes.

### 6 NEWS PLUS

Products, events and inside information.

### 10 ON-LINE WITH A MODEM

How to phone a host of databases from your PCW.

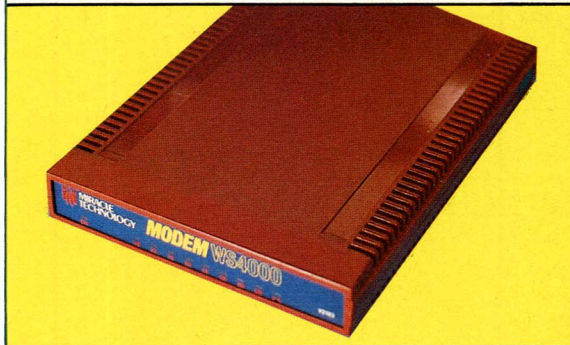

### 17 BOOK LOOK

Two new tomes on written and writing software.

### 18 A DESKTOP MOUSE DESKTOP

Review of the AMS mouse, and a new face to CP/M.

### 20 FILE MANAGER

A database for your trusty PCW. What's it like?

### 23 DATA PROTECTION ACT

Have you registered? Should you? The facts.

### 24 QUICKIES

Self Start and Micro-Plus under scrutiny.

### 28 MAIL 232

A quick trip round the CP/M comms utility.

### 31 A RACY STORY

How a PCW helped Peter Gowing with his custom cars.

### 34 LOCOSCRIPT 2

The first major review.

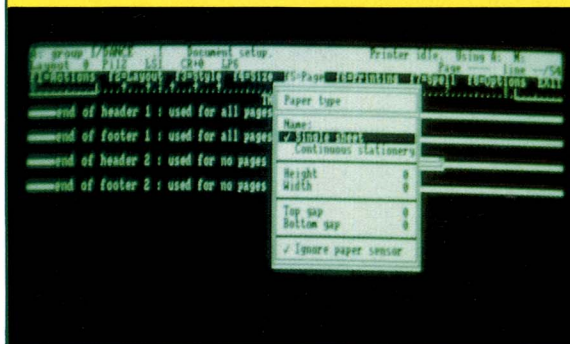

### 40 NEWSDESK INTERNATIONAL

As Pocket Calculator Weekly hits the streets, we look at the technology which brought it to you.

### 45 STARGLIDER COMPETITION

Win a copy of Rainbird's graphic supergame.



### 46 GAMES GALORE

Take a frame with Davis or put a foot on the footplate of the Southern Belle.

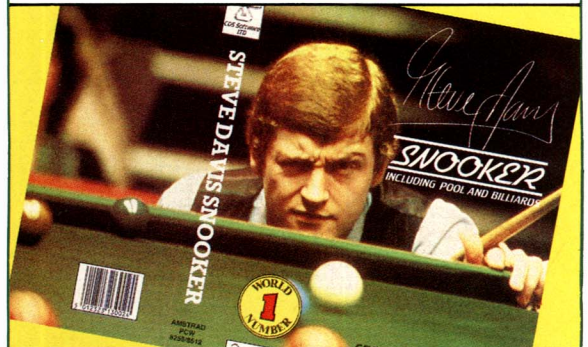

### 49 FREE TEXT DATABASE

How to build your own with a little HELP.

### 54 LOOPS AND STRINGS

The final part of our simple BASIC course.

### 56 LANGFORD'S PRINTOUT

David Langford muses on things micro.

### 59 LOADS OF LISTINGS

Double column print and a graphing program.

### 65 PUBLIC DOMAIN

More off the peg programs for next to nothing.

### 67 A TRIP TO THE TIP

Three more pages of hints and tips.

### 72 GOOD SOFTWARE GUIDE

The revamped games guide with more to offer.

### 80 SPECIAL OFFERS

Goodies from the Barn's 'cupboard under the stairs'.

### 85 LOTS OF LETTERS

More sackfuls of correspondence.

Arnor  
LTD

# PROGRAMMERS!!! READ ON.....

## THE ARNOR

“C”

## THE 1st FULL IMPLEMENTATION

of the K&R standard on the Amstrad. Features include: optimising compiler★linker★PROTEXT program mode editor★I/O & math. libraries★full floating point★32 & 16 bit arithmetic★conditional compilation★macros★complete operators guide.....

£79.95 (incl. VAT & P&P)



## MAXAM II

## THE BEST ASSEMBLER

on the Amstrad, now under CP/M+ (as used by all the leading software houses.) **PLUS** the most powerful monitor ever seen under CP/M **AND** the PROTEXT program mode editor. Features include: Z80 assembler, now with macros★single stepping★conditional breakpoints★full expression evaluation★examine **ALL** memory banks★links to C★complete operators guide and much more...

£79.95 (incl. VAT & P&P)



## BCPL “FOR HUMANS NOT COMPUTERS”

(CWA MARCH '87)

The system programming language that is easy to learn and easy to use, the ARNOR BCPL is a full implementation, compiling to Z80 M/C code and is extremely fast. Also includes: debugging routines★I/O libraries guide★CP/M and AMSDOS version in same pack!

(incl. **FREE** ROM for CPC owners).

£39.95 (incl. VAT & P&P)

**ALL THREE PROGRAMS ON DISC FOR AMSTRAD PCW8256/8512 OR CPC 6128**

AVAILABLE NOW IN ALL GOOD COMPUTER SHOPS OR DIRECT...

24 HOUR CREDIT CARD NUMBER 01-684 8009 (6 LINES)

OR WRITE FOR FREE CATALOGUE

118 WHITEHORSE ROAD, CROYDON CR0 2JF



Arnor  
LTD

## THE LIMERICKS, THE LIMERICKS

As Quasimodo was driven slowly gaga by the incessant ringing of bells, so the entire staff of 8000 Plus have been driven down to the Unicorn by the continuous stream of excruciating Limericks pouring from the lips of vengeful mailpersons as they heave the sacks through the door.

We've had many hundreds of

Val Davies, Truro. Peter Hoare, Nottingham. G. Webb, Brighton. A.G. Helyar, Newhaven. Brian Kealy, Ripon. R.L. Webb, Bognor Regis. Colin O'Hare, Bridgwater. Rowland Riley, Poole. Steve Goodwin, Flitwick. D.G. Lucas, London SE17. F. Pagden,

rhymes ranging from the bawdy to the downright obscene, and have set half of Somerton cringing at the less worthy attempts.

After countless hours of sifting and re-reading, we cut them down to a short list of about 40, and tried these out on a hand-picked gaggle of poets, critics and other drunks. As a result, the winners are:

Wetherby. H. Hutchins, Ickley. M.A. Metcalfe, Boscastle. A. Shawyer, Chertsey. S. Gallagher, Blackburn. R.R. Mayson, Kendal. A. Stredwick, Eastbourne. D.B. Minterne, Dorchester. J.A. Pringle, Darlington. P.W. Rogers, Catterick Village.



"I GOT HER THROUGH A COMPUTER DATING AGENCY"

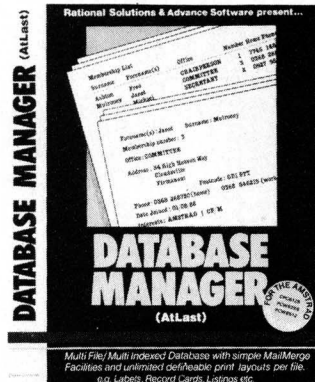

Each will receive a copy of 'At Last'; well done.

We're sure you'd like to read a selection of the winners (well, not exactly sure, but we don't see why you shouldn't suffer too), so here is a random selection, most of which have the right rhyme pattern, even if the scansion leaves something to be desired. Remember that the only condition was that they had to end with 'at last':

Through the pub door a white figure passed  
And the barmaid screamed out, all aghast.  
As she clung to Mine Host,  
He grinned and said, "Ghost?  
It's our new stock of spirits, at last!"

A lady with lusts that were vast  
Stored gen on the men she'd amassed.  
Now she uses her Joyce  
To sort men from the boyce  
From lists listing lusts in 'At Last'.

There was a young man who did cast  
His hook in the water too fast.  
It caught in the knickers  
Of a friend of the vicar's,  
Who shouted, "My luck's changed at last!"

## EVERY DAY IN EVERY WAY

Apart from *LocoScript*, around which the micro was to a large extent designed, software on the PCW has taken advantage of few of its hardware features. Many of the 'hardy annuals' of the CP/M world, while working well and giving valiant service on a 'word processor', are tied to the more normal 80 by 24 screen size, or demand that you learn a complicated set of commands before you can use them in anger. In the last few months, though, it does seem that we're beginning to see a change in the style of program which is being released on the PCW.

It started with games. The clever clogs at the games software houses realised that it really wasn't that difficult to produce detailed graphics on the PCW screen, and even though it is only monochrome, you could still produce some interesting shading effects which would enhance the game.

More recently, other products have come along which make more of the machine than this. 'Resident' programs, which hide in the background while you're running other software and only pop up when called by a specific key-press. WIMP programs, which allow you to pick options from menus or by moving a pointer to a small diagram of the function on the screen. Graphics programs, which allow you to draw on the screen using a mouse or light pen. All these innovations help to make the machine easier and more efficient to use.

It doesn't look to be stopping there, either. Pre-release versions of new software we've seen look like stretching the PCW into new areas, where the usefulness of the machine will be increased still further. Over the coming months you should be able to make more and more productive use of your PCW. Starting that move is the release of the long-awaited *LocoScript 2*, given its first showing in this issue. Following on from this are a number of other products, still under wraps at the moment. It promises to be a bumper summer.

Simon Williams

## Point taken

Just in case there are any other readers thinking of sending us gaudily printed letters in 5 hues, we are now aware that HSV Computers can supply coloured ribbons for the PCW printer. We will endeavour to read our own adverts in future.

We don't seem to have offended HSV too much, as theirs was among the many letters received, and they took the opportunity to order a TIPOFFS book (have you got yours yet?).

8000  
PLUS

The JUNE issue of 8000 Plus will be on sale on THURSDAY MAY 14th. Why not place an order with your newsagent?

# HOTSHOT – A SIDEKICK FOR LOCOSCRIPT

With the large number of PCW users out there, news of a new SideKick style desk-top organiser that will work with LocoScript should create a fair amount of interest. A new company is being set up to launch HOTSHOT, a package aimed at organising the life of the dedicated LocoScript user.

For £34.95 it will apparently offer an address book, a diary, a notepad and a calculator. You can access a clock with an alarm and a calendar that we are assured is correct from the date that the Gregorian Calendar was first introduced.

It is to have a fast word counter (100 words per second – about 8 seconds to count an average 8000 plus page) and it will have a novel coder that will stop spies reading your confidential files unless they know a password of up to 32 characters. It will even stop you reading the file if you forget your 32 character password.

These features are all instantly accessible from LocoScript (you create a new Start of Day disc that loads it automatically when you boot up). It displays on the top four lines of the screen. As both LocoScript and HOTSHOT are on

view at the same time one useful feature is the ability to paste information direct from HOTSHOT into your LocoScript document.

This means that you can paste addresses from the address book direct into a letter as a simple form of mail merge or you can put the result of your calculations directly into the right place in your document.

The programmers claim a great deal of flexibility for the package, especially in the sections where data is stored. An estimate of the average data capacity is 200 names and addresses, 50 calculator memories, 150 appointments in

the diary and 150 short notes in the notepad.

You can allocate space within the 40K of storage space for the features you use most. If you mainly use the address book, you can devote up to 16K of space to it or you can choose to give the extra memory to the notepad, the diary or calculator.

Maths brains should be interested in the ability to modify the calculator. If you give the calculator the maximum 16K, you can define up to 500 variables which convert it from a simple four-function facility into a full blown scientific calculator. You can choose an accuracy of up to 10

decimal points.

The 40k of data held in drive M: can be saved on your start of day disc when you have finished with LocoScript. The designers have tied HOTSHOT in using standard LocoScript keys, so they claim it should be simple for users to get to grips with.

HOTSHOT can be used with the 8256, with LocoScript 1.2 (it uses up 61k in drive M:) although you will need an expanded M drive or an 8512 if you want to use it with LocoSpell or LocoMail.

We are assured it will be ready within the month and hope to carry full details in our next issue.

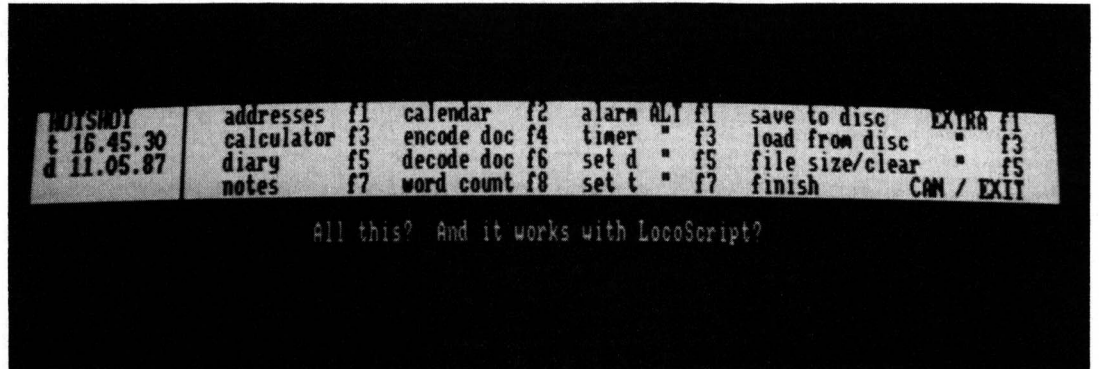

## GUILD OF THIEVES

Those of you who have been reading the pages of 8000 Plus closely might be expecting an expose of unscrupulous software manufacturers here, but it turns out that Guild of Thieves is the name of Rainbird Software's new adventure game.

It is set in the mystical land of Kernovia (the mystical land created for the Golden Joystick Award winning *Pawn* game). It is, according to the makers, packed with 'a huge number of complex puzzles and 30 magnificent scene-setting illustrations'.

The game gives you 'the greatest career move you'll ever make', it seems, by allowing you to join an elite band of professional rapsallions – the Band of Thieves (employees of the Inland Revenue should feel particularly at home).

If you want your wits and ingenuity taxed to the limits by having to find all the treasures on a mysterious island you will probably gladly part with £24.95 for the pleasure. Once you've mastered this one there are another five new products from the same team due to be launched in the next two years.

## BIT ON THE SIDE?

All users interested in 'A Bit on the Side' obviously have over-expansive computations, for this is the title of a utility from Aware Software of Formby which will print spreadsheets sideways. What do you mean you would never have guessed.

Your spreadsheet can be printed in eight different fonts in four sizes without all that cutting and pasting to produce a lengthy (or is that widthy?) report. It also works with any ASCII file, sideways or normally and includes a disc management file to copy, erase, rename and type files – all for £24.95.

## DON'T COME UNSTUCK

All those users with Sandpiper Accounts, Sandpiper Payroll and Sandpiper File Manager might be interested in sticking them together with a new interface called *Glue*. This £99.95 facility allows you to pass data back and forward between the three packages, and to import and export it to other software packages. It also has a Calculator.

## IS ANYBODY THERE?

Is your PCW lonely? ASD Engineering have come up with the answer this month by launching Uninet – a low cost, flexible network system that will allow any number of computers to be linked. This means that an office with a number of PCWs, Amstrad PCs or even BBC Micros or Apricots can send files back and forward between them.

And if you invest in one of the company's new 40 Megabyte PCW hard discs, also launched this month, you can link it in with a PCW to act as a central 'file server' for the whole system.

The system acts like an improved version of the Northern Computers Network system – it uses the same custom chip. Northern's system had a dedicated file server with its own in-built computer. The ability to use a PCW for this task when needed (and of course to use it for other purposes when it is not needed) makes for a more cost-effective set up.

Any number of computers can be linked (at a distance of up to 1 kilometre) using ordinary telephone cable, and using a 'gateway' you can transmit data via modem to other computers or networks.

The system will cost around £175 per computer (£200 for a system which uses the PCW's serial or parallel ports). The 40 Megabyte hard disk will set you back a further £871 + VAT although you could use ASD's 20 Megabyte hard disk at £599 or even the 10 Megabyte at £449 for this purpose.

The 40 Megabyte unit is supplied in a low profile case to fit beneath the computer monitor and connects, via an interface box to the computer expansion port. A specially modified version of CP/M Plus and LocoScript are provided with the unit which allows them to handle large hard disks ('regular' LocoScript can only handle disks of up to 4 Megabyte).

**VIDI ON THE VIDEO**

Tired of looking at boring old words and figures on your green screen? Try the new Rombo Video Digitiser, snatch a picture from your video, store it in your PCW and print it out on your faithful old printer? You can then write all over it with boring old words and figures.

The £99.95 digitiser is a neat white box that fits into the expansion port at the back of your PCW. This links into your video recorder or video camera and you can then see a series of pictures flashing up on the screen of your PCW. You have control over brightness and contrast and at the correct moment you 'grab' the particular image you want. This can be made up of two shades (black and green) four shades (black and three shades of green), or a very complex 16 shades (black and fifteen shades of green).

Once you've captured the image, you can specify the size of a window to work on and you can move the window about the screen. We are told you can even touch up pixels if it gives you pleasure. You can then save these works of art on disc - each full screen taking up about 22k of space - or print them out. More fun than a spreadsheet - eh?



▲ A Rambo picture of the editor remonstrating with his staff.

**HOLD THE FRONT PAGE**

As the 8000 Plus editorial team battled wearily to this month's deadline, into the office breezed Mirrorsoft's marketing whizz, Pat Bitton, with a copy of *Fleet Street Editor Plus* under her arm. Nothing seems to fascinate hoary old journalists (especially hoary old computer journalists) more than a

program that allows you to make up pages - even if they have just spent the last week or two doing nothing but making up pages.

Mirrorsoft have been selling *Fleet Street Editors* for other micros for some time but the Plus in the title reflects the added sophistication of the PCW version

(as with the magazine of a similar name).

As a gauge of how sophisticated the program is, it virtually fills both sides of a three inch disc. Once loaded, it gives you a remarkable amount of control over each stage of building up a multi-page publication. It comes with a good

collection of 'clip art'—illustrations that can be mixed in with the text, and there are a variety of type faces and sizes available.

The program is due on sale by now at £69.95. See next month's issue for a full review.

## A STAR PRINTER IS BORN

Star Micronics UK Ltd has launched a new £589 dot-matrix printer – the NR-15. It offers improved performance on Star's NX-15 with 240 c.p.s. in draft and 60 c.p.s. in near letter quality. The makers claim real simplicity with touch-sensitive controls for all major functions. These allow you to choose print mode, pitch settings

form length, and margin settings.

It has both tractor feed and semi-automatic sheet feed as standard, with a low cost cut-sheet feeder also available. It comes with Star's standard slot-in interface system that matches the printer to the computer. Bet there isn't a PCW version.

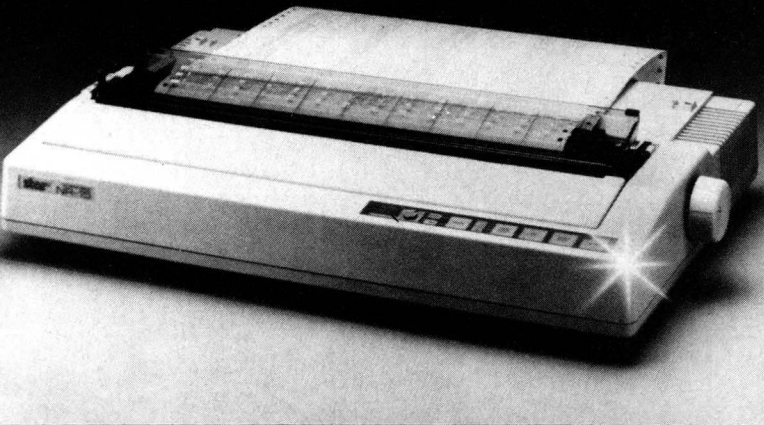

## TURN YOUR PCW INTO AN ATOM BOMB

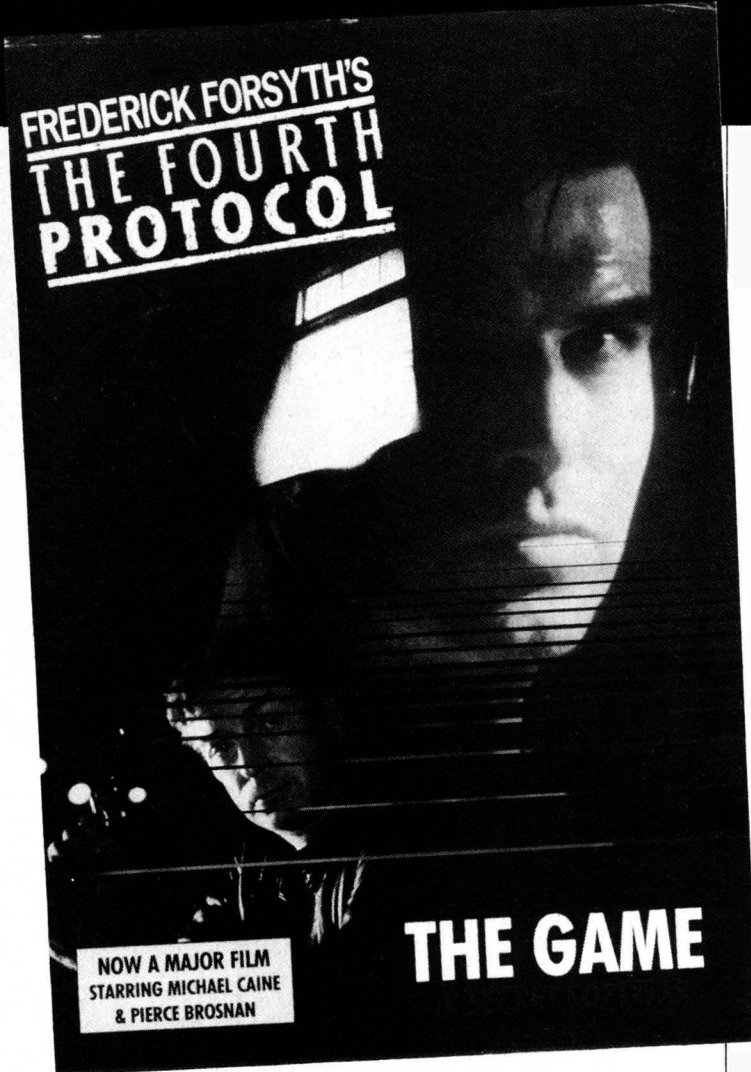

## COMPETITION FOR 8000 PLUS?

Perhaps it's the bracing West Country air, but a new publication has been launched from Seaton in Devon to compete with 8000 Plus for the title 'Best publication on the Amstrad PCW West of Yeovil.' *PCW File* is not really a glossy competitor for 8000 Plus, but a non-profit making periodical aimed at enthusiasts.

Chris Bryant, the editor, is aiming at producing a forum where users can 'share experiences, write articles, hints and tips and help users if they get stuck on a problem'. The subscription fee is £5 for six issues which are to appear at about two monthly intervals. They are aiming at around 32 pages per issue, depending on contributions.

They have a small amount of Public Domain software which is free to subscribers (with a stamped addressed envelope and a

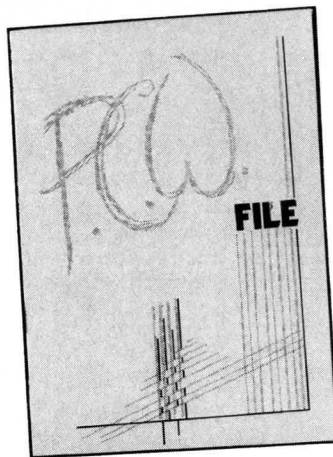

formatted disc). Non-subscribers will have to pay £2 per side extra as a copying fee.

Anyone interested can receive a sample copy by sending a SAE to Chris Bryant, 11 Havenview Road, Seaton, Devon EX12 2PF

*The Fourth Protocol* – you've read the book, you've seen the film, now play the game. To coincide with the launch of the film of Frederick Forsyth's novel, Ariolasoft have launched their new game full of the fun to be had in British counter-intelligence.

Your task is to stop a group of Russian agents assembling and detonating a nuclear device in a basement bedsit. To do this you pay £15.99 and become John Preston of MI5 (if you complete the game you can go on to publish

your memoirs in Australia).

To make it slightly more interesting there is a book of instructions that looks slightly longer and considerably more complicated than the original novel. The main purpose of this seems to be to tell you what to do if you're stuck. No peeking now – that's cheating. Oh, by the way if you don't beat this ingenious game we're told your PCW explodes and demolishes everything within 10 miles. Adds a certain urgency to the game.

## ANONYMOUS MUD-SLINGERS

One interesting piece of information that came into the office this month was a letter, neatly printed and very official looking, informing us that a certain software company was pulling out of the British market due to poor sales.

It was a good story only spoilt by one vital fact. The company concerned are doing better than ever and have no intention of going anywhere. So we strapped the story and decided to run a little piece on the strange letters we get at 8000 Plus.

8 8000 PLUS

## DOWNRIGHT CHEEK DEPARTMENT

Among the entries to our *At Last* limerick competition was one from a surprising source, and with surprising sauce. Campbell Software (publishers of the rival *Masterfile 8000*), sent the following entry:

It is truly the star of the cast.  
It's performance is quite unsurpassed.  
For power that is faster  
You have to choose MASTER  
FILE 8000 at last.

Bit of trouble with the last line there fellers?

# Attention all PCW8256/8512 users

Buy over £50 worth from this list, and get a FREE Word Plus™ spell corrector/proof reader/ crossword and scrabble solver, worth £24.95.

(NewWord purchasers get a free copy of Companion as Word Plus is bundled!)

## Cracker2-PCW

The hi-res graphics spreadsheet

Why settle for a text-only spreadsheet when the best costs less? Cracker2 is the ultimate CPM80 spreadsheet, with functions, features and facilities to tackle the most complex financial, mathematical and scientific tasks. File and command compatible with the PC version. **£49 inc.**

## Accounting software from Sage, Compact, Camsoft, MAP

We supply all the leading accounts systems, and will be pleased to offer our advice on the best solution for your business. Prices from £49.95 to £199.99 covering all aspects of accounting, payroll, stock control etc.

## NewWord2-PCW

The professional's choice **£69**

Wordprocessing on a micro computer *can* be a very transportable skill: especially if you learn the command system that's in use on more computers than any other in the world. NewWord2™ starts where WordStar™ leaves off, with conditional merge print, undelete, save format with document. A 45,000 word English spell corrector is included.

## Touch'n Go

Teach yourself to type using drill and exercise techniques **£24.95 inc**

## Crash Course

Teach yourself to type using carefully designed english texts **£24.95 inc**

## Two Fingers

Convert from 2 to 10 finger typing for **£24.95**

## dBASE2-PCW

**£118 inc** starts you out in life with the most widely used micro computer data base managamanet system of them all. Another upwardly mobile skill that will stand you in good stead wherever your computing interests lead. dBASE2 provides an excellent basis for VP Info or dBASE3. Files are transportable to & the PC with C-STAM.

## CSTAM

File transfer from PCW to PC and back again. **£49.**

A high speed and simple to use menu-driven method for the accurate transfer of data (via RS232 connection) from the PCW to the IBM PC and compatibles. Also from PCW to PCW, or PC to PC. Transfer data files such as Cracker or Supercalc spreadsheets,, text files from NewWord, LocoScript etc.

## MicroCollection

A sophisticated card file database manager complete with specialised label generator, simple word processor. Features include password protection, a full range of report and input form design features. High speed indexing, and facilities to output ASCII data for merge printing with NewWord, WordStar and other WP systems. **£49.95**

## Trivial Pursuit: Genus Edition

3000 mindless questions for those with nothing at all better to do. **£19.95**

## Hitchhikers Guide to the Galaxy

Arthur Dent needs your help! **£29.95**

## Classic Adventure

Get back to the roots of the computer game with the grand daddy of them all **£14.95**



Software Limited  
200 North Service Road  
Brentwood, Essex  
CM14 4SG

sales: tel 0277-220573  
tlx 995143 NEWSTA G  
fax 0277 232637

**Call 0277-220573**

with Access/Visa

Ask for our colour catalogue covering PCW and PC software products. All offers are current for the month of magazine edition only - so buy NOW!

# PUTTING IT ON THE LINE

One of the biggest growth areas in computer usage these days is telecommunications, or comms for short – communicating with other people via your computer. With a bit of extra hardware, the appropriate software, and a telephone line, you and your PCW can send messages to anyone else with similar equipment, and access many on-line databases and services.

## What is a modem?

The signals given out by your PCW are not the same as those on the telephone network. A modem converts or 'modulates' signals from your PCW (coming via the RS232 socket of Amstrad's CPS8256 interface) into the levels carried on telephone lines. It also works the other way for signals coming in - they are converted from telephone system voltages to RS232 levels. This process is 'demodulation'. The modem gets its name from the first three letters of each word.

Most modems today, including all those covered by this article, are 'direct connect' modems. This means they plug into the new-style British Telecom jack sockets (if these aren't fitted in your house, you'll need to contact BT about them).

To go 'on-line', you type a command on the PCW keyboard and the modem takes over the line and dials the number of the service to which you want to connect. You can't use your telephone while the computer and modem are using it.

Anything typed at the PCW keyboard will be sent down the telephone line and appear on a computer somewhere else. While you are using the modem, you incur normal phone charges, and you can connect to anywhere the phone system will reach.

## Electronic Mail

Electronic mail, or *Email*, is what most business people buy modems for. This is the way it works. Various companies and some individuals provide a host computer and sell accounts. When you subscribe, you are allocated an account number and told the telephone number of the computer. You then dial the computer and connect your modem. The host computer sends text direct to your screen, announcing itself, and asking for your account number and password.

To send a message you type something like SEND, the host computer asks you for the name, or perhaps the account number, of the recipient (another user of the same service). You then receive a prompt to type in the text of your message, which you finish with a special character, which varies from system to system. The next time your recipient logs on to the same computer, he will find the message when he selects READ.

In essence, that's Email. In practice most systems offer other features such as copying a message to several people, or even to all callers, and confirmation that your message has been received. Telecom Gold allows you to put your message at the top of the recipients pile

(although if everyone used this, it would lose its effect), and to attach an incoming message to an outgoing one - if A has written to you, you can add your comments and send it to B.

Most terminal software also provides extra features. The main two are uploading and downloading. You would not normally want to compose anything more than a brief note whilst on-line i.e. connected to the phone, because of course you are clocking up telephone charges. The normal procedure is to write your message or messages in LocoScript, and save them to disc or RAM disc before connecting to the phone.

When on-line, most terminal software offers you the option to send a previously prepared message from disc. You proceed to the point where you would start typing a message, press the 'send disc file' key, and give the filename. Press [RETURN] and the disc file 'types' itself into the host computer. This method has the added advantage of providing a copy of the message. The process is known as 'uploading'.

Downloading is the reverse process. As well as receiving the message on screen, you direct it to a named disc file, to read or print out later.

Email can be a very cost effective method of communicating with people. The major systems usually charge at local call rates, and it only takes a few minutes to send even quite long messages. Unlike the post, Email communication is instant, and unlike phone calls the other person need not be there.



The big snag is that you can only talk to other people on the same system. Prestel and Telecom Gold claim 60,000 and 44,000 subscribers respectively. The other systems figures are not available but are smaller. However, if you are communicating with a small group - your customers, a known group of colleagues etc, then this doesn't matter.

## Prestel

Prestel is a large public database run by British Telecom. Prestel screen displays are different from most other systems, looking more like the teletext displays of CEEFAX and ORACLE on television than the normal 80-column scrolling computer display.

Prestel has large sections devoted to certain areas of business. A huge section is given over to the travel trade, who use it extensively for booking work, and there are sections devoted to farming, law, medicine and so on. There is also a lot of useful public information such as train times, information about various UK towns and cities, foreign countries and so on.

If you are interested in the PCW as a computer, there is a microcomputer magazine called Micronet. Within this there are two sections called Amsnet and Amsters Cage devoted to the Amstrad range, including the PCW 8256/8512. Some of the features are a bit on the technical side which may or may not be to your taste. Also on Prestel is the much advertised Bank of Scotland Home and Office Banking system (HOBS). With this you

can move money around, pay your credit transfer bills, and generally do most things except getting cash.

Note that on top of the standing subscription to Prestel, there are additional charges for services such as Farmlink, HOBS and Micronet. These may be levied in the form of chargeable frames - some of the pages you look at on Prestel have a price in the top corner of between 1 and 99 pence. (You always get a warning of these on the menu frames). More often the charge is made by setting up a Closed User Group (CUG) where you pay anything between £20 and £1000 a year to be a member.

The main reason why Prestel is different from the other services is that about half the users (according to unofficial reckoning) are non-business users. Contact with other home users can be great fun, especially if you're housebound. When you're on a bulletin board, all that matters is that you have something to say - not that you are elderly, disabled, shy or whatever.

Messaging on Prestel is done in Viewdata frames (screenfuls) which only carry about 150 words. The multiple send feature is messy, the store is very limited (6 messages) and there are no acknowledge or attach facilities. It is only really good for short notes.

Prestel does offer a Telex facility, but this is done through the messaging system, and is cumbersome to use. The other snag with messaging on Prestel is that, at the moment, it only runs at 1200/75 baud (although this may soon change). Although receiving messages at 1200



baud is acceptable, sending them at 75 baud is excruciatingly slow.

### Telecom Gold

This is primarily a business service offering quite sophisticated messaging, and a lot of business information. Unlike Prestel, the messages can be of any length and will retain their format, so for instance, you can send tables that come out aligned. An interesting feature is that if you carry a BT Radiopager, you can be paged whenever there is a message waiting in your mailbox.

Telecom Gold allows you to send messages in other ways. The most important business use is probably Telex. Many people use Telecom Gold just for this. See the list for charges involved when using Telex. You can also send Telemessages (the modern equivalent of Telegrams).

There are a number of databases on Telecom Gold. There is the Official Airline Guide (OAG), a comprehensive list of current scheduled flights from UK airports, the entire UK train timetable, booking facilities for theatre tickets and other commodities. There is an on-line personal diary system, a spelling checker and live chat facilities, where you can 'talk' to another user who is also logged on.

### Microlink

Microlink is a section of Telecom Gold, in the same way that Micronet is a section of Prestel. The telephone

numbers and so on are the same. The difference is that Microlink doesn't appear to cost anything extra. If you join Microlink, you join Telecom Gold as well, and it would appear that you can access everything on Telecom Gold.

The extras available to Microlink are a computer news section, telesoftware (listings you can download into your computer) and a bulletin board, which includes a well-used Amstrad section. Microlink is run by Database Publications, who publish a number of Amstrad magazines (*Really? - Ed*), and the news and telesoftware is culled from their printed output.

Telecom Gold offers either 'club' or 'corporate' membership - individuals effectively join as clubs. Microlink's application form only offers individual membership.

### Other services

One-to-One and Easylink are competitors to Telecom Gold. They offer the same sort of messaging facilities as Telecom Gold or Microlink, but not much else. I didn't have a chance to log on to these two services, but from their publicity information, One-to-One's special features are free time for the first 30 seconds (good for a quick mail check), free incoming telexes, and a printing service - they will type out your message and send it as a courier letter.

Easylink offers the Email and telex facilities, and a few specialist services but little else in the way of features. It does however have its own local call access system, avoiding PSS charges (see box).

### Bulletin boards

With the spread of cheap computers and auto-answer modems, many computer enthusiasts have set up their own miniature versions of Prestel and Telecom Gold. These private services are known as bulletin boards.

They are usually run on a single telephone line, and some are not 24 hour services as their operators are sharing the line with the rest of their families! The quality and scope of these boards varies, depending on the skill and enthusiasm of the system operator ('sysop' for short).

## Baud rates

**Baud rates are a measure of how fast data is being sent down the phone lines. If you divide the quoted rates by 8, you will get the number of characters per second. The CPS8256 will support many baud rates, but the only ones used with modems are:**

**300/300 baud also called V21  
1200/75 baud also called V23  
1200/1200 baud also called V22  
2400/2400 baud also called V22bis.**

**The first number is the speed data is received, the second is the speed it is transmitted. The modems covered here will only work at the first two speeds, but virtually all on-line systems in the UK use these speeds. Prestel like all Viewdata systems is V23 only. The other commercial services listed operate at both speeds. 1200/75 is better if you are mainly receiving, but 300/300 is better if you are doing a lot of sending - 75 baud is very slow.**

Most offer Email, public domain software for downloading, and some news items. Some offer on-line games and other special features. By and large they are totally free to use, and when using them you should always remember that someone is running the service purely for love. Be polite, leave thank you messages, and if you can contribute to the board, do so.

Many boards have special interest groups, although these are mainly categorised by microcomputer type. However there are some boards totally dedicated to particular topics, such as science fiction, photography, or religion.

Bulletin boards work in a similar manner to the big system. You log on, type your name and password, and work through menus to find what you want. The free systems set up your password the first time you log-on. ▶

# ONTEST

Now you know what you're missing, you'll probably want to get on-line as soon as possible. As well as your Prestel or Telecom Gold account, though, you'll need a modem and software to manage it and the telephone line. Here are some recent releases, designed for use with the PCW.

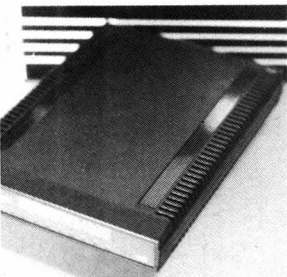

## MIRACLE TECHNOLOGY WS4000 (PCW version)

Miracle Technology Ltd • 0473 50304  
● £195.45

This modem has one major advantage over others reviewed here. With the WS4000 you don't need a CPS8256 interface, which represents a saving of £70. The modem works by having it's own built-in serial interface.

### PLUSES

- No CPS8256 required
- Hayes commands supported
- Well made unit
- Good, detailed manual

### MINUSES

- No on/off switch

RANGE OF FEATURES  
EASE OF USE



PERFORMANCE



DOCUMENTATION



8000 PLUS VALUE VERDICT

You simply plug its cable into the back of your PCW. You can't use the modem's serial interface with other computers - an important point if, say, you plan to upgrade to a PC. However, the connection is entirely standard, and you can use any suitable software with the WS4000. There is a version of the WS4000 produced for other computers which can of course be used with a CPS8256. This 'standard' WS4000 is about £30 cheaper, so if you need the CPS for other reasons, that's the one to get.

The WS4000 works at V21 and V23 speeds only, performs auto-dial, auto-answer, and responds to the standard Hayes command set. It will store up to sixty numbers internally, although this is only necessary if your software doesn't have a directory feature. For advanced users, there are many auto-answer options, together with timing and other controls. The manual is a 96-page spiral-bound document which covers the entire Miracle intelligent modem range, including the upmarket WS3000, which costs over £700 with all options.

### Verdict

In summary, this modem is as good as the Pace Linnet, and better than the other two reviewed here. Whether you buy the Linnet or WS4000 depends on your need for the CPS8256, and whether you prefer Dialup or Chit-Chat.

## ASTRACOM 1000 and KIWICHAT

Astracom • 0792 473697 • £212.75

This intelligent modem is different from the other three reviewed here, as it isn't Hayes compatible. The modem must therefore be run with Kiwichat, the supplied software, if auto-dialling and other intelligent features are to be supported. Technical experts could write their own driver in Chit-Chat.

Astracom are producing a Hayes compatible version of their modem, which should be available by the time you read this. The modem should then be usable with other software, if you want.

The modem is much like the others in terms of features. It is a V21/V23 model. There is a 75/1200 baud mode, allowing the modem to be connected to 1200/75 services. The modem will auto-dial, and auto-answer, and allow control of attributes from the computer. It has an 'equalisation' feature which can be used to improve communications on noisy telephone lines.

One extra that the Astracom has over the other modems is a printer port, to which text passing through the modem can be sent. Unfortunately, it's a Centronics printer port, so it is probably not a lot of use to PCW owners. The Astracom manual supplied was marked provisional and consisted of 14 photocopied pages. All the modem commands are covered, but you don't need to know them if you're using Kiwichat. One important point about the Astracom - unlike the others it does not yet have BABT approval. Without this, it cannot be recommended.

### Kiwichat software

This program is supplied with the Astracom 1000, and is not available separately. Viewdata and scrolling (Email) modes are supported. The latter is known as 'VT52' mode as it behaves in the same way as a popular computer terminal of that name. All the usual features are offered, and this one does support XMODEM transfers!



The Prestel section is also good, and contains all the necessary page storing and uploading features. It offers an interesting feature where two Prestel screens can be shown at once, using normal narrow characters instead of the wider ones in the 40-column emulation. Kiwichat has a separate installation program which permanently configures various things such as passwords and telephone numbers.

Kiwichat has a separate manual which is PCW specific. This manual as supplied was also a few sheets stapled together, and was rather thin on explanation. 8 pages isn't really enough to cover all the features of this software, although you can probably get by from on-screen instructions, if you understand the services you are using. A new manual is due for release when Astracom receive BABT approval.

### Verdict

Assuming Astracom get BABT approval, this modem and software package make a reasonable combination if you already have the CPS8256 and a limited budget. However, there is nothing to particularly commend this system over the others, and a thin manual, and non-Hayes command set are minus points. It works out about £15 cheaper than the Pace Linnet plus Sage software.

### BABT approval

Anything you attach to the phone system must be approved by the British Approvals Board for Telecommunications, otherwise BT may disconnect your line. All approved items carry a 'green circle', while unapproved items must carry a 'red triangle'.

### PLUSES

- Just about the cheapest (if you have a CPS8256)
- Centronics printer port

### MINUSES

- Not BABT approved
- Poor documentation
- Less robust casing

RANGE OF FEATURES  
EASE OF USE



PERFORMANCE



DOCUMENTATION



8000 PLUS VALUE VERDICT

## TANDATA TM500

Tandata Marketing • 0684 892421  
• £228.85

This modem is a fairly basic intelligent modem, with auto-dialling, baud rate selection (V21 and V23 only) and result detection ie it can distinguish between engaged, no answer, and number unobtainable. It uses the Hayes command set for auto-dialling and baud rates (with a special extension for 1200/75 baud), and worked well with both of the software packages reviewed. As it doesn't have auto-answer, it is not suitable for bulletin boards. The manual supplied is brief, but does contain a useful glossary of comms terms.

The modem is a small plastic box about the same size as a thick paperback book, and has an on/off switch on the front. A nice touch is that they have supplied a plug on

the mains cable. Tandata have been making modems for a number of years, and I have used another model, the TM512 for over a year now without any problems. I expect that this one will be just as reliable. I rang the Tandata help desk in the course of preparing this review and found them to be knowledgeable and helpful.

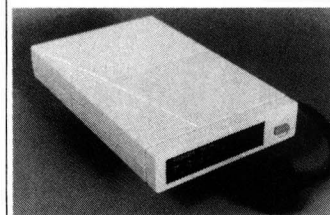

<b>PLUSES</b>		<b>MINUSES</b>	
<input checked="" type="checkbox"/> Hayes command compatible	<input type="checkbox"/> No auto answer	<input type="checkbox"/> No number store	<input type="checkbox"/> Limited manual
<input checked="" type="checkbox"/> Fitted mains plug			
<b>RANGE OF FEATURES</b> ■■■□□	<b>PERFORMANCE</b> ■■■□□	<b>EASE OF USE</b> ■■■□□	<b>DOCUMENTATION</b> ■■□□□
<b>8000 PLUS VALUE VERDICT</b> ■■■□□			

## PACE LINNET MODEM

Pace Micro Technology • 0274 488211  
• £159.85

This modem is also a V21/V23 only model, but has a few more features than the Tandata. It will auto-dial and auto-answer, again using the Hayes commands, and has a built-in number store for automatic dialling - although you won't need this if you are using either of the software packages reviewed.

The Linnet also has automatic speed detection of the service being called, as long as it's either V21 or V23. That's a very nice feature if you don't have a directory on your software, but again, it isn't as important if you do. However, this feature and the auto-answer make it a good choice for running bulletin boards. The manual is a 56-page detailed document, much of it highly technical, but it does cover everything the modem can do in great detail.

Physically, the Linnet is very similar to the Tandata. It doesn't have an internal power supply, but has one of those transformers built into the plug, feeding low voltage into the back of the modem. One criticism I have of the Linnet is that it doesn't have an on/off switch - you have to unplug it at the back or at the wall. I'd say this was a better buy than the TM500, but look at the prices - a lot depends on what combination of software and modem you choose.



<b>PLUSES</b>		<b>MINUSES</b>	
<input checked="" type="checkbox"/> Automatic baud rate detection	<input type="checkbox"/> No on/off switch	<input checked="" type="checkbox"/> Phone number store	
<b>RANGE OF FEATURES</b> ■■■■□	<b>PERFORMANCE</b> ■■■□□	<b>EASE OF USE</b> ■■■■□	<b>DOCUMENTATION</b> ■■■■□
<b>8000 PLUS VALUE VERDICT</b> ■■■■□			

## DIALUP PERSONAL

PMS Communications Ltd • 021 643 7688 • £89.99

This package offers very similar features to Chit-Chat. Again scrolling and viewdata systems are supported, the scrolling section saves text to disc, prints it out, and will transmit text from disc. The Viewdata section stores and prints frames in a similar manner.

Both packages also allow the manipulation of text and Viewdata frames while off-line. Dialup's directory isn't as daunting as the Chit-Chat version when it comes to editing. Unlike Chit-Chat, the package also supports other formats, such as Times Network and Dialink, their own proprietary service, which are a mixture of scrolling and Viewdata. The Viewdata implementation is very similar to the Chit-Chat one.

Where Dialup scores in that it supports file transfer. The scrolling section supports the XMODEM system, used by virtually all bulletin boards, and also a new improved transfer system known as KERMIT, which is starting to appear on many services. In Viewdata mode, the standard file transfer system is the CET Protocol, and this is also supported.

PMS have decided to produce one manual for the entire range of computers for which the software is produced. As a result large sections of the manual are concerned with the differences between various computers, and even worse there are a lot of references to 5 1/4 discs, [ESCAPE] and other non-PCW points.

The Dialup software can't run with a standard RS232 cable - you have to use their cable which contains a 'dongle' - an anti-piracy device. Even if you copy the

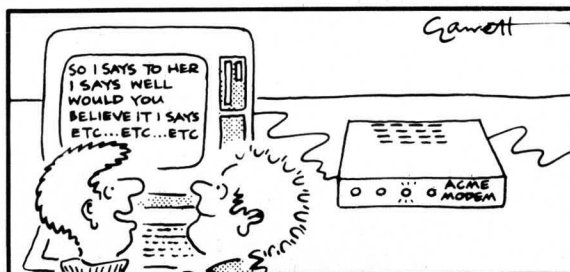

software, you can't copy the cable. This software is £89.95, again a bit pricey. Once again there is a modem deal which improves the price.

### Verdict

Dialup is very easy to use. The comprehensive file transfer facilities make it the best choice for those needing this feature. As this package is available on other micros (and PMS claim that it looks very similar in all its versions), it is well suited to a mixed micro environment. If you want to use comms in many different ways, get this package. Both companies offer a helpline service. The PMS one is free forever, the Sage one for 90 days, then you have to pay.

<b>PLUSES</b>		<b>MINUSES</b>	
<input checked="" type="checkbox"/> Comprehensive file transfer	<input type="checkbox"/> Multi-micro manual	<input checked="" type="checkbox"/> Easy to install	<input type="checkbox"/> Pricey
<input checked="" type="checkbox"/> Runs from the M drive			
<b>RANGE OF FEATURES</b> ■■■■□	<b>PERFORMANCE</b> ■■■□□	<b>EASE OF USE</b> ■■■■□	<b>DOCUMENTATION</b> ■■■□□
<b>8000 PLUS VALUE VERDICT</b> ■■■□□			

### service charges

**Prestel** - £6.50/£18.00 per quarter for private/business users. 6p per minute except Saturday p.m. and Sunday. Some frames carry charges (1-99p). Ring 01 822 1122 for information.

**Telecom Gold** - £40.00/£300.00 pa for private/business users. Ring 0800 400419

**One-to-One** - £50.00 registration. Calls free for 30secs, then 10p per min. Ring 01 351 2468 for information.

**Easylink** - £40.00 registration. Standing charge 12.95 per month. Calls at 10p per min.

## SAGE CHIT-CHAT COMBO Sagesoft plc • 091 284 7077 • £99.99

This is a general purpose package which will work with Viewdata services such as Prestel, and ordinary scrolling or ASCII services such as Telecom Gold and One-to-One. This covers 99% of services. The Combo package is a combination of two other Sage packages, Chit-Chat Email and Chit-Chat Viewdata. These are quite separate in the way they operate, but they share some common facilities.

### Yellow pages?

The software is primarily designed to be used with

intelligent modems; those with auto-dial and baud rate switching under computer control. A directory of numbers is supplied on disc, containing all the major services, and a good list of bulletin boards.

You select a service off a LocoScript-style menu. Chit-Chat then dials the service, and connects you. Each telephone directory entry can be edited to ensure that the baud rate, screen format and so on are right. Also, most services will involve typing a password and identity, and these can be entered in the directory as well. The manual quite rightly warns that it is not a good idea to enter your password into Chit-Chat, in case someone else uses your PCW.

### Scrolling service software

This part of the package is sold separately as Chit-Chat Email. There aren't actually many features needed in an Email package, and Sage have included the essential ones (bar one). The program stores incoming text to disc, prints it out, and can transmit text from a disc file. It also lets you view a disc directory while you're on-line. All these functions work well, and are all you really need for electronic mail. The missing item is file transfer.

If you want to transfer Locoscript files, programs, or anything else other than a plain ASCII format text file, you need special file transfer routines in your comms software. For example, a lot of the free software on bulletin boards can only be obtained using a file transfer facility called XMODEM, which most scrolling software packages provide.

### Viewdata software

Viewdata is a problem on the PCW as the format is really designed for colour systems. Chit-Chat's emulation is quite good, but no attempt has been made to suggest colour by shading, and some graphics frames don't make a lot of sense. The same features as in the scrolling software - print, save frames to disc, and send text to Prestel mailboxes, are provided. Once again though, there is no facility for Viewdata software downloading, which may rule the package out for some people.

### Bits and bobs

Also provided with the pack is a text editor to prepare messages. You can of course use LocoScript (1.20 or later), but using the text editor means you don't have to leave the program. This is quite usable, and heavy Email users will appreciate being able to alter text files without leaving Chit-Chat.

A novel feature of the program is a 'task' facility. You can create task files which will automate the communications process. For example you can define a task to wait until midnight, log-on to Prestel, collect your mail and save it, log-off, log-on to Telecom Gold, collect mail from there and log-off, all without you touching the keyboard. There is also on-line help at all stages of the program, telling you what each facility does.

### Manual

The manual is 112 pages long and contains lots of help in using the services, with actual examples of sending and receiving Telecom Gold mail. It covers everything a beginner would need to know, but experienced users might find it a bit difficult to locate what they want quickly. Such users should use the on-line help facility.

### Verdict

This is a good pack for business users. The beginner's manual and user-friendliness of the software make it trouble-free if you don't want to be an expert. The price of £99.00 is a bit on the steep side, but if you buy it with a modem, it looks a lot better. However, the lack of file transfer facilities mean it can't be recommended for the enthusiast.

Board	Number	Baud rate
CBBS London West	0895 420164	300,1200/75
Computers for Christ	0395 272611	300
Healthdata	01-986 4360	1200/75 Viewdata
Compulink	0483 573337	300,1200/75
Dental Board	0227 276162	300
The Gnome at Home	01-888 8894	1200/75 Viewdata

## JARGON BUSTER

**ACOUSTIC COUPLER** - a low cost and portable type of modem which has two rubber cups into which you push a telephone handset.

**AUTO-ANSWER** - a feature of a modem which means it will respond to someone calling you, and connect them to your computer.

**AUTO-DIAL** - a feature of a modem which means it will dial a host computer using a number supplied from your computer, without you having to dial manually.

**BULLETIN BOARD** - a small-scale messaging service, normally provided by a private individual.

**DATABASE** - in comms, this means the static information, as opposed to messages, held on a host computer (timetables and the like).

**ELECTRONIC MAIL** - also called Email. Messages and letters send to other people using computers and the telephone system.

**HAYES** - A standard for modem control, named after the company that devised it.

**HOST** - A large computer which provides the information, stores and transmits the messages, and usually receives the calls on a service such as Prestel or Telecom Gold.

**INTELLIGENT MODEM** - A modem with auto-dial and auto-baud rate

selection is usually referred to as 'intelligent'.

**LINE NOISE** - The crackle and hiss that appears on phone lines, manifesting itself as unwanted characters on a computer screen.

**LOG-ON** - or logging on. The act of dialling the remote computer, connecting the modem to it and typing in your password.

**MODEM** - a hardware device which 'modulates' computer signals into the electrical equivalent of audio tones, and 'demodulates' them back again.

**PSS** - Packet Switched Stream. A British Telecom Service to allow access to remote computers at local call rates. Telecom Gold, Microlink and One-to-One use the system outside London. This adds to the cost of using these services, but is still cheaper than a long distance call.

**SYSOP** - SYSTEM OPERATOR. A person who runs a bulletin board.

**TERMINAL** - the opposite to Host. The computer which accesses the host. For you, the term refers to your PCW.

**VIEWDATA** - a type of computer display based on 'frames' of 24 lines of 40 characters. Some characters can be block graphics. Viewdata displays are normally in colour, but obviously not on the PCW!

### PLUSES

- EMail tips in the manual
- Easy to install
- Free registration to Microlink/One to One

### MINUSES

- Pricey
- No file transfer

RANGE OF FEATURES  
EASE OF USE

■■■■□□  
■■■■■□

PERFORMANCE  
DOCUMENTATION

■■■■□□  
■■■■■□

8000 PLUS VALUE VERDICT ■■■■□□

# Now

# NEWSDESK INTERNATIONAL

**AVAILABLE NOW!**

At long last it is here, the complete desktop publishing system for Amstrad PCW, its name — **NEWSDESK INTERNATIONAL**.

With the extensive experience gained from producing the unique PCW Light Pen, Mouse and Video Digitiser, The Electric Studio Products Limited are probably the best qualified to bring you this much sought after product.

**NEWSDESK INTERNATIONAL** allows you to use ASCII files created with Locoscript which can then be read in and structured into columns around your pictures and illustrations.

Text variations are possible using a variety of font styles and sizes, with numerous justification, offset, and pagination options.

In addition a graphics library is included on disc to make **NEWSDESK INTERNATIONAL** a stand alone product in its own right.

Control is via the cursor keys with the option of using either the ESP Light Pen or Mouse, with the package accepting digital input from Camera or Video recorder, via the P8 Video Digitiser.

Graphics creation is fully catered for by the inclusion of the latest version of our highly acclaimed "ART" Package, providing the user with a multitude of functions.

- SIMPLE AND EASY TO USE
- WINDOW SELECTION WITH ON SCREEN PROMPTS
- ALLOWS INPUT FROM LOCOSCRIPT FILES
- EASY MIXING OF TEXT AND GRAPHICS
- FULL A4 PAGE COMPOSITION
- FACILITY TO SELECT MULTIPLE COLUMN WIDTHS
- VARIABLE PARAGRAPH INDENT
- FULL JUSTIFICATION WITH RIGHT/LEFT/CENTRE AND MICRO OPTIONS
- CHOICE OF STANDARD OR PROPORTIONAL SPACING
- COMPREHENSIVE IMAGE MANIPULATION WITH RE-SCALING AND ROTATION
- 5 STANDARD FONT STYLES ALLOWING 3 DIFFERENT POINT SIZES
- FONT EDITOR FOR CREATION OR ALTERNATE STYLES
- SINGLE OR DOUBLE DENSITY OUTPUT

Up to now we have produced peripherals which have been acknowledged as the best products for the Amstrad PCW. We feel confident that **NEWSDESK INTERNATIONAL** will set the standard that other desktop publishing systems will be unable to match.

*We stand by our reputation ...*  
**THE BEST PRODUCTS AT THE BEST PRICES**

**AVAILABLE NOW**  
**ONLY £49.95**  
including VAT and P&P

**Sample layout of A4 page using NEWSDESK INTERNATIONAL**

## ORDER FORM

Please rush me:

- NEWSDESK INTERNATIONAL**  
Comprehensive desktop publishing system @ **£49.95**
- PC8256/8512 LIGHT PEN**  
Complete with Interface, 'ART' disk & Manual @ **£79.95**
- PC1512 LIGHT PEN**  
Complete with software @ **£19.95**
- PCW MOUSE**  
Complete Mouse graphics package @ **£129.95**
- MOUSE FONT MODULE**  
Now available @ **£19.95**
- VIDEO DIGITISER**  
The ultimate graphics input device. Choice of two models @ **£99.95**  
PCW 8256/8512  CPC 6128
- SNIP ART**  
Collection of digitised images for use with 'ART' package @ **£14.95**
- FONT EDITOR**  
Complete — for use with 'ART' package @ **£19.95**  
Please indicate version required:  
Light Pen  Mouse

Name ..... Mr/Mrs

Address .....

..... Post Code .....

Cheque/P.O. for £ ..... is enclosed

Debit my Access/Visa Card No: .....

Expiry date .....

Signature .....

Please fill in and return to:

**THE ELECTRIC STUDIO**  
Unit 13, The Business Centre,  
Avenue One, Letchworth,  
Herts. SG6 2HB

**TRADE ENQUIRIES:**  
**0462 675544 (Export Sales Only)**  
**0462 834864 (Home Sales Only)**

**DIRECT ORDER HOTLINE:**

**☎ 0462 675666**

**THE ELECTRIC STUDIO**

# HSV COMPUTER SERVICES LIMITED

## CONTINUOUS STATIONERY – MICRO PERF ALL EDGES

	QTY			
	250	500	1,000	2,000
9.5" × 11" 60 GSM – White	£2.95	£4.95	£8.95	£14.95
True A490 GSM – White	5.25	8.75	14.95	–
True A4 100 GSM – White Bond	6.50	9.95	16.25	–
True A4 100 GSM – Coloured Bond – cream, blue, grey	7.25	13.50	25.50	–
Labels 3.5" × 1.5" (1 across)	–	2.95	4.95	9.50
Labels 4.0" × 1.5" (1 across)	–	3.25	5.50	10.50
Labels 4.0" × 1.5" (2 across)	–	3.75	6.50	11.95
Labels 2.75" × 1.5" (3 across)	–	2.75	4.50	8.50

## PRINTER RIBBONS

Amstrad 8512/8256 .....	£3.95ea	Amstrad DMP2000 .....	£3.95ea
Amstrad 8512/8256 (red, blue, green, brown, orange) ..	£4.95ea	Amstrad DMP3000 .....	£3.95ea

## DUST COVERS

PCW 8512/8256 Set of 3 .....	£8.50	PC1512 Set of 2 .....	£9.50
CPC 6128 Set of 2 .....	£8.50	DMP2000 Printer Set of 1 .....	£4.50

## NEW PRICES

## DISKS

Amsoft/Maxell 3" CF2 .....	1 – £3.10	5 – £14.95	10 – £27.95
5 1/4" DS/DD 48tpi .....	10 – £6.95	20 – £13.00	30 – £19.00

## DISK STORAGE BOXES

## Price Each

10" × 3" Hinged Lid – Holds 10 (cased) .....	5.95
20" × 3" Hinged Lid Lockable – Holds 20 (cased) .....	9.95
50" × 5 1/4" Hinged Lid Lockable .....	7.95
100" × 5 1/4" Hinged Lid Lockable .....	11.95
120" × 5 1/4" Hinged Lid Lockable .....	12.95

## AMSTRAD FILECARD

Dysan 10MB File Card – 1512 IBM Compatible .....	£395.00
--	---------

## PRINTER STANDS 80 COLUMN

Smoked brown acrylic for rear or centre feed printers .....	£14.95
---	--------

## TILT 'N' TURN MONITOR STANDS

12" Monitor .....	£12.95	14" Monitor .....	£14.95
-------------------	--------	-------------------	--------

## REXEL BINDERS

9 1/2" × 11" Blue/Red/Black (please state) .....	each £2.50
--	------------

## ★NEW★ STARTER PACKS PCW/PC

### PCW 8256/8512

5 3"CF2's
250 Sheets A4 90 GSM
500 4 × 1 1/2" labels
Dust covers
Tempmate
Beginners Guide Book
<b>£32.95</b>

### PC1512

10 5 1/4" DS/DD Disks
250 Sheets A4 90 GSM
500 4 × 1 1/2" labels
Dust Covers
Tempmate
Ribbon (please state)
<b>£25.95</b>

Please quote  
REF 01/8000

**ALL OUR PRICES INCLUDE CARRIAGE & VAT – NO EXTRAS TO PAY!**

HSV COMPUTER SERVICES LIMITED, 40-42 New Market Square, Basingstoke, Hants RG21 1HS  
CREDIT CARD HOTLINE (0256) 463507

# HSV

# THE WISDOM OF SOLOMON

## THE SOFTWARE BUSINESS £5.50 • Meyer Solomon • BBC Publications

When you look around at the variety of software packages on sale, it's very tempting to think, "I could do that!". With software going for between £15 and £100, it seems that if you can write a good program in your spare time which might sell a few hundred copies, then you could potentially make several thousand pounds. Great! Resign your job today, go freelance, your fortune is assured but don't tell the taxman.

Meyer Solomon is Software Editor for BBC Publications. His job is to evaluate software and books from hopeful writers, knock them into shape for publication and negotiate terms with the authors. Using his experience in these areas, he has written 'The Software Business', a guide giving do's and don'ts to help you, but also to make you think carefully about what you are doing and your prospects for success or failure.

The book is a brave attempt to provide some genuinely helpful and useful information. It succeeds in parts, but when it comes down to it, guidelines on 'How To Succeed' are necessarily a little fatuous. There was a Monty Python sketch which went something like: 'And now, how to win a Nobel Prize for medicine. First you learn all about medicine, then become a doctor and cure

all of the world's diseases.' That about sums it up.

However, if the first half of the book is full of comments like 'make sure there is a market for your idea' and 'think carefully', the second half perks up a lot. Solomon covers the mechanics of approaching publishers once you have written a demonstrable program, what they will expect of you and what you can expect of them.

There is a whole wealth of information packed into the last 50 pages, full of names, addresses, prices and facts. Everything from how to get ISBN numbers for books you publish, to a sample contract of the kind you would get as a first time writer. The information covers both programming and technical book writing.

There is advice on how to write adverts, how to get magazines to plug your product (tip: always send a photograph, preferably as both black-and-white print and colour slide) and what to do if you get a bad review, or worse still, an unfair review.

What it comes down to is that having a good idea is something that no-one can teach you to do. 'The Software Business' tries to teach you and fails. However, taking your idea and marketing yourself to a publisher is something you can learn, and you will find much useful help in this book.

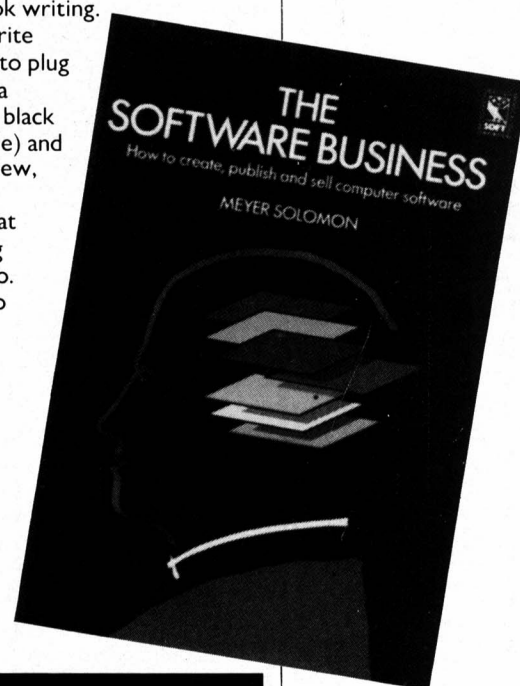

The Software Business  
ISBN 0 563 21141 5  
8000 PLUS VALUE VERDICT ■■■■□

## POCKET WORDSTAR £7.50 • Ian Sinclair • Glentop

Ian Sinclair is to computer books what Barbara Cartland is to romantic fiction – both churn 'em out at one a month, and all their titles sell pretty reliably.

There are differences of course; Barbara Cartland probably isn't much cop at CP/M for one, and not many of Ian Sinclair's characters gaze lovingly into their disc drives and swoon. Usually, Ian Sinclair's books are a model of clarity, among the best for beginners.

This book is aimed specifically at PCW owners, which is what separates it from other WordStar tutorials. WordStar is famed for using obscure command keys, but on the PCW the range of extra keys on the keyboard allows you to use them instead.

It has to be said that this is one of Sinclair's less distinguished books. He doesn't seem quite sure who the reader is: most PCW owners who haven't used WordStar before (ie. who will buy a tutorial book) will have used LocoScript for a while, and therefore will know the basics of how to use the machine. The first page of the book tells you how to plug the three parts of your PCW together (which assumes a total novice), and by page 13 you are deep into altering the margins in rulers and configuring your printer options (which assumes a large previous experience of wordprocessing).

There are a distressing number of little errors and misprints that do not inspire confidence in the author.

Sinclair believes the 8256's rear expansion port is for attaching a second disc drive. One section states it is about to discuss the X and Y commands, and goes on to discuss the X and R commands. Trivial, but irritating.

There is not a single screen shot in the entire book, which is criminal – you can't compare the book examples with what you see on your screen. No mention is made of NewWord, the WordStar workalike which has outsold WordStar on the PCWs. NewWord is almost identical to WordStar but has several important differences – there should have at least been an appendix.

The MicroPro WordStar manual is generally one of the better examples of technical writing to be found. To be honest, you would be better off reading that, together with the PCW-specific addendum that your dealer will inevitably give you when you buy WordStar. EXIT

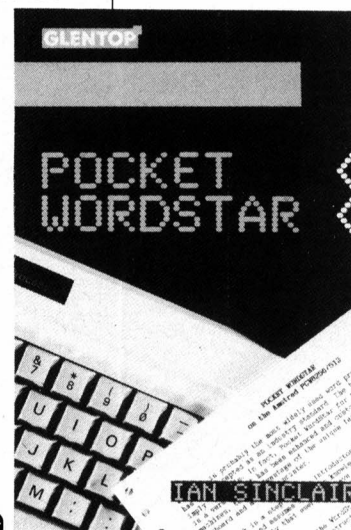

Pocket WordStar  
ISBN 1-85181-083-8  
8000 PLUS VALUE VERDICT ■■■□□

# THE MOUSE FINDS A HOME

**AMX MOUSE & DESKTOP**  
 £79.95 • Advanced Memory Systems • 0925 413501

Is a 'mouse' a real breakthrough for the PCW or is it a rather extravagant extra to clutter up your desk. This month Advanced Memory Systems launch the AMX desk top package, where the mouse can at last show its paces in the proper 'WIMP' environment. Alec Rae decides whether it could prove a useful pet for the PCW user.

Desk top packages are commodities that always sound good in the adverts. In the world of the 'paperless office' it seems almost blasphemy still to be taking notes on the back of used envelopes or looking up a phone number in a dog-eared address book. But often the practicalities of the average desk top package makes it too bothersome to use regularly.

The new AMX package goes a long way to overcome these problems and presents its services in such a way as to make them attractive and easy to use. The package is an 'organiser' like the Gem desk top for the PC and is a reasonable facsimile of the famous Apple Macintosh set-up.

For those who are wary of using CP/M it allows you to move, copy and erase files and run programs without even bothering about whether it is P I P M : = A : or A : = M : . It has a diary, telephone book and a note pad that are real practical propositions and it allows you to create any number of memos (now that is real organisation). You have a clock with an alarm, a calculator that works well and even a puzzle that is annoying enough to keep you going for days. All this without touching your keyboard in a genuine WIMP environment.

Great ingenuity goes into the design of the screen icons, as if it was a serious possibility that a large number

**WIMP**

as everyone probably knows by now, stands for Windows, Icons, Menus and Pointer. A WIMP environment is either a program that uses these devices or the dressing room for the Mr Punyverse Competition.

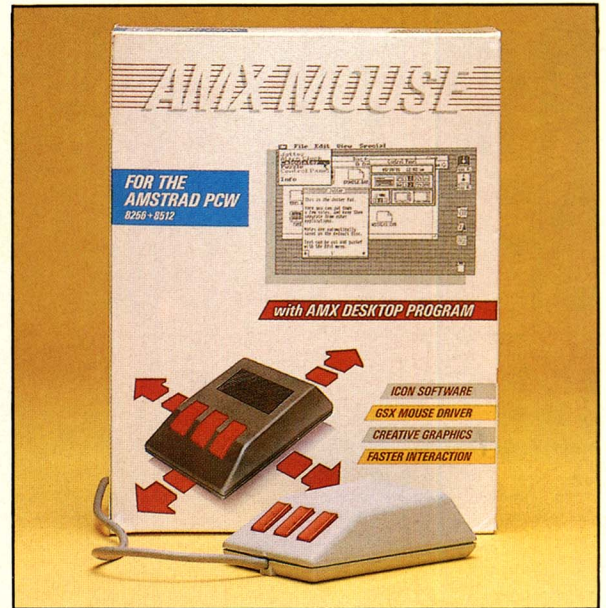

of dyslexic people would go out and buy word processors. When you are given the choice of keyboard repeat rate, Desktop shows a snail (for slowness) at one end of the scale and a car (for speed) at the other.

You can view the directory on any drive either in boring old text or by Icon. Program files are shown by a little picture of a screen while the text file icon has writing on the front. Most interesting are Mallard Basic files which are each depicted by a little Locomotive.

**File it in the bin**

Once you display this directory, the world is your oyster. You can 'drag' files around by putting the pointer onto the file, pressing the operating button and pulling the file to the correct place. You can erase files by dragging them to a little bin icon, and move files to the M drive or B drive by dragging them to the appropriate disc icon.

You can also run a program from any drive by clicking on its icon. Desktop doesn't affect any key assignments you've made with SETKEYS, so you can safely leave your word-processing program in drive M and call it up when you need it.

Desktop takes over 80K of your M drive, an important consideration for 8256 users, but as it carries out all the functions of PIP.COM, DIR.COM and SHOW.COM you don't need these utilities cluttering up the drive.

**Here we are again**

The neat part of Desktop is that when you leave your chosen program you are automatically taken back to AMX Desk Top, loaded from your M drive. This overcomes the basic problem with 'organisers' – remembering to use them. You still need the AMX disc in the A drive when you want information from your diary or telephone book, but it is still easier and more convenient than many of its competitors. When you eventually leave Desktop you are asked if you want to retain any diary or phone book changes and, if so, you have to replace your Desk Top disk for updating.

This automatic linking back to the AMX program can cause a few minor problems. Should you try to run a text file, the program thoughtfully informs you that you cannot open it (you can only run applications like Disckit, WordStar or SuperCalc). You can, however, print it or 'type' it – display it on the screen as with the TYPE command in CP/M. It does this easily but then immediately returns you to the desk top before you have a chance to read it, unless you are quick to press [PTR].

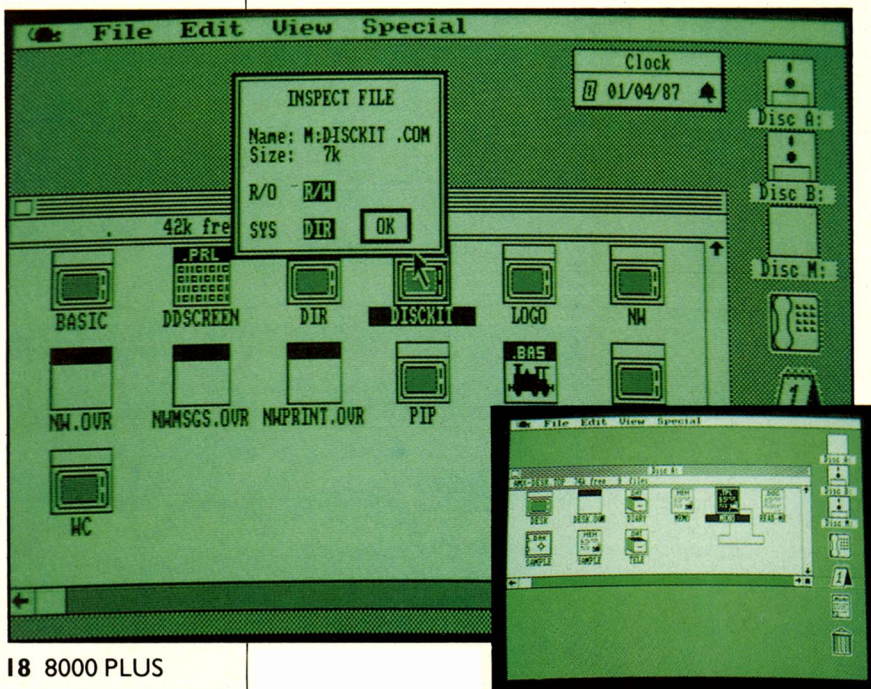

You can't use the pull down menus from within other programs, but this is often a rather unsuccessful facility in other desk top programs. The note pad only provides limited space, but if you want to write great swathes of text you would probably use your word processor anyway.

These are minor irritations when compared with the potential of the package. It is easy and pleasant to use and does everything that it sets out to do. The telephone book is quick and efficient and has an effective 'Find' facility, that could actually make it quicker to use than a 'manual' telephone book.

## Dear diary

The diary, although perhaps limited for space, seems practical enough to use. If there is an entry against a given date it is highlighted on the calendar so you have no excuse for forgetting to look. You can pass back and forward through the months with ease and can use the calendar feature to work out the day your birthday is on up to the year 1999 (*sensibly avoiding the century leap year problem* – Ed). After that you have to guess.

The ultimate feature for all aspiring bureaucrats is a special memo-writing option which neatly lays out all your memos and then stores the result to disc. The editing here is made slightly more complicated by the use of the mouse. Most of the effects you would want are available (paste, cut, copy, clear, justify centre and inserting or deleting lines) but you have to refer to an option at the top of the screen to carry out these simple tasks. You pick out the text or move the cursor around the page with the mouse, and this takes a moment or two to get used to. Still it is a facility that no red-blooded executive should live without.

Notes are taken under an option disarmingly called the 'Jotter'. This gives you a potential of five pages of notes and more importantly you can move from page to page easily and quickly. You can even transfer text from one facility to another using the paste routine.

A four function calculator is available and worked either from the mouse or the keyboard – it's quite convenient to use the mouse.

You can set the time and date in a small clock window and perhaps more interesting you can set an alarm that bleeps away merrily, as long as you have Desktop on screen. As you mainly use the program as a link between other programs this is less useful than it might seem at first. It is invaluable, though, if you set your mind to solving the 'simple' sliding block puzzle.

This puzzle is a faithful copy of the trend setting Apple Macintosh one and doesn't seem to be any easier than the original. The manual gives you nine possible solutions (including one marked ominously 'Impossible') which you can work towards until senility sets in or the alarm goes off to point out that you have just wasted two or three hours of your life.

## One at a time

The only problem with pulling out the many windows is that you cannot use a window that is overlapped by another one. Every so often you get an message window telling you to close all the others that overlap before you can use a facility.

The best way round this is to adjust the size of the windows, a simple exercise using the mouse. For instance the directory window can be expanded or contracted at will – you can still use it at its reduced size to find the file you want.

The other possibility is to actually move the windows around the screen to suit your needs or artistic sensibilities. This system is not infallible, though. Try as you like it seems impossible to show the jotter and the 'phone book at the same time.

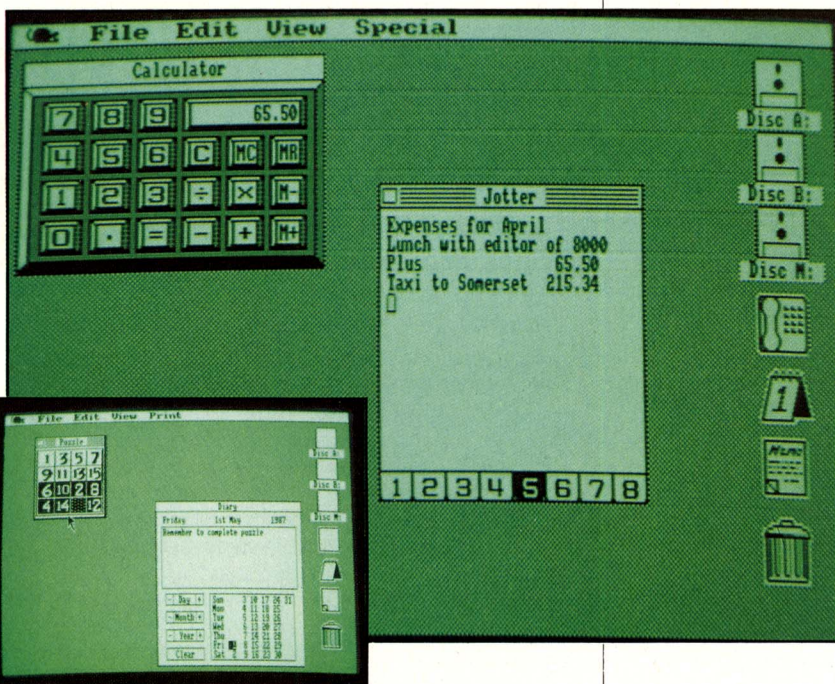

## Verdict

The mouse itself is not a thing of beauty in grey with 'something bright at night' red buttons. The action is not as smooth as some mice but it works well enough. It soon becomes such a natural extension to your hand that you have to think what to do when you eventually have to use the keyboard again.

The program at last provides a desk-top organiser that you would really use to 'organise' your life with the PCW. It would also be very useful to those who are wary of taking the plunge into the twilight world of CP/M. **EXIT**

### PLUSES

- A genuinely useful desktop organiser, well presented and easy to use.
- Makes CP/M commands easy.
- Provides a 'phone book and notepad practical enough to use.

### MINUSES

- Mouse is slightly erratic.
- Takes up a lot of space in the M drive to use.
- Can be a nuisance if you really want to use CP/M

RANGE OF FEATURES   
EASE OF USE

PERFORMANCE   
DOCUMENTATION

**8000 PLUS VALUE VERDICT**

## To a mouse

Nowadays Rabbie Burns wouldn't recognise the "wee sleekit courin' timorous beastie" that he spoke of in his poem. The modern mouse has dropped the verminous reputation of his rodent predecessors and is making a home for himself with friendly computer users.

The mouse is now a hand-sized box of plastic with buttons on the front and a long tail of cable joined to an interface which fits into the expansion slot in the back of your PCW. The AMX version comes with its own expansion slot for 'piggy-back' additions (Amazing the number of animals joining the world of high technology.)

The mouse runs on a metal ball that allows you to move it around your desk

(or special 'mouse' mat). As you move the mouse the cursor moves on the screen. When you reach the relevant menu or Icon you simply press the button on the mouse to make your choice.

The AMX mouse has three buttons - one for choosing, one for cancelling and one to use on special occasions (like when you are moving a number of files at the same time.) Until now there has been little software written to take full advantage of the mouse but the recent launch of various mice and the announcement of a flood of suitable software means that soon no self-respecting PCW freak could afford to be seen without a long-tailed friend.

# RAPID RUNAROUND

## FILE MANAGER

£99.95 • Sandpiper Software • 0978 355333

According to the results of our reader survey, more PCW users are considering a database as their next software purchase than any other application. Databases vary a lot in facilities, quality and price, and Sandpiper's File Manager comes into the higher price bracket for PCW products.

You can look at File Manager on two levels: the fully fledged database can handle up to three files simultaneously and relate them together to save having the same information recorded twice in different files. It allows a fair amount of 'customising' – you can create a database to fit your particular working method and the way you currently store your information.

If you don't require a tailored filing system, you can build a simple, card index style database using the RAPID database generator, supplied with the package. This will probably be enough for most people.

### Following the instructions

The first thing you notice about File Manager is the 160 page manual with the nicely drawn Sandpiper logo. The next thing you notice is that the 160 pages are badly duplicated, riddled with spelling mistakes and typos, and arranged in a most peculiar order with the tutorial section at the back.

The main criticism is that the tutorial section concentrates on telling you what keys to press, without giving an overview explaining why you are doing things. Having completed the tutorial, you're not left confident that you could define a database for any other application.

### RAPID

Most users will approach File Manager from the RAPID generator, which is intended to take much of the detailed work out of designing a database. It offers only limited facilities when compared with a custom-designed database, but is much easier to use.

The first job is to design the screen display. The program uses a rudimentary screen painter which allows you to type background text straight onto the display, position and define your fields, and add line graphics. There is also a clever routine to outline areas of the screen with boxes.

This originality is marred, though, by unnecessary restrictions. You can't use either of the delete keys, but have to use  to insert a space and  to delete one. There's no facility to move or copy text and the whole screen appears in the top left hand corner of the display.

When you come to define the fields of your database, there is a wide range of parameters, including, of course,

naming the fields. Each field should have a unique name, so that File Manager can distinguish between them. Unfortunately, no attempt is made to check for duplicate field names, and it is possible to accidentally give different fields the same name.

Having designed your screen, you can call up RAPID to generate the rest of the database specification. This it does quite quickly, leaving you with a number of 'RAPID' files on your disc. Talking of discs, you have to ring Sandpiper and ask for a special code before you can even use the program. This kind of protection has grown very unpopular, and it's easy to see why. What happens if you buy your software on a Saturday morning?

### Long playing records

When using File Manager, each record in the main database is displayed with the layout you designed earlier. You can add a record to the datafile and change it later; you can call it back to the screen by entering the contents of one or more 'key' fields. What you don't appear to be able to do is to browse through your records sequentially. Although you could probably program this into your database, it's not included as standard in a RAPID-generated file.

You can print your records and save them as screen copies. You can also define selection conditions and calculations which File Manager will use on your file, but to do so you have to learn the full version of the program, rather than relying on RAPID to do much of the work.

The whole system is incredibly hesitant. Even with the small file set up to review the product, File Manager took several seconds to save or decide to print a record. On a large file, this would make the system very slow. Even moving the cursor up and down the screen took an appreciable time, and on one occasion corrupted the screen.



### The bottom line

It's important to separate File Manager from its manual. If you thought the LocoScript manual was hard to follow, then you won't stand much chance with File Manager's. It's badly organised and obviously written by someone who is much too close to the product (probably the programmer). It is very hard to work your way around and doesn't clarify several important points on the use of the program.

File Manager itself has a lot of potential, but in its present form fails to realise it because of some silly restrictions, slow operation and annoying working methods. Although the RAPID generator can put a simple database together quickly, you'll need a good knowledge of programming to design a complex customised system with File Manager. If you need this kind of system, Masterfile 8000 is a better bet.

### Jargon Buster

There are three main terms used when describing databases. If you think of a database as a computerised card index, they each have a physical equivalent.

A **file** is like the box in which you store all the cards.

A **record** is like a single card within the box.

A **field** is a single piece of information on the card, e.g. a name, telephone number or date.

<b>PLUSES</b>		<b>MINUSES</b>	
<input checked="" type="checkbox"/> Potentially a powerful and flexible system	<input type="checkbox"/> Appalling manual	<input type="checkbox"/> Poorly customised for PCW use	<input type="checkbox"/> Full system very complex to use
<input checked="" type="checkbox"/> RAPID generator can produce simple files quickly			
<b>RANGE OF FEATURES</b> ■■■□□	<b>PERFORMANCE</b> ■■■□□	<b>EASE OF USE</b> ■■□□□	<b>DOCUMENTATION</b> ■□□□□
<b>8000 PLUS VALUE VERDICT</b> ■■□□□			

**AT NABITCHI COMPUTING WE STILL MEAN BUSINESS ON YOUR PCW!**

**PCW8256 PCW8512 COMPUTERS**

You Could Pay £1000 For A PC And Printer With Software.

**We Only Charge For The PCW8256**

**£ 373.00** less vat  
Includes printer & software

**And If You Think You Need More Power The PCW8512 Is Only**

**£ 469.00** less vat  
Software & Printer free

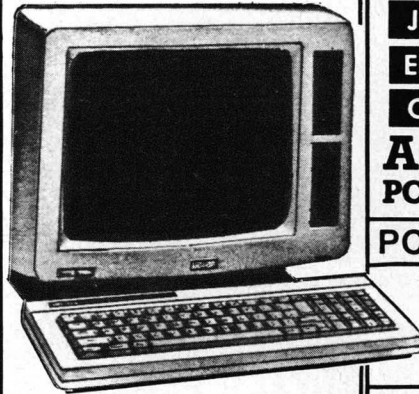

**HARDWARE FOR YOUR PCW'S:-**

**PRINTERS**

**JUKI 6100 DAISYWHEEL** £322.00  
inc vat.

**EPSON MATRIX FX105** £546.25  
inc vat.

**CANON LASER LBP8** £1900.00 +Vat

**AMSTRAD DMP3000** £194.95  
PC Compatible Dot Matrix Printer inc.vat

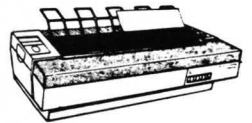

**PCW8256 MEMORY UPGRADE**

Full Kit Of Parts Only £22.00

plus vat

**D.I.Y. In Less Than 15 mins**



**PCW8256 2nd DISK DRIVE**

The Real 3 inch 1 Meg Amstrad FD2 2nd. Drive (just plug it in!) £120.00  
plus vat

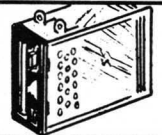

**AMSTRAD CPS8256**

**CENTRONICS/SERIAL INTERFACE**

Plugs Into Back Of PCW For Printers (Centronics Port) plus vat And Modems (RS232 Port) £52.00



**PACE AMSTRAD MODEM**

**PC Phone Home! With A Modem On Your PCW** £89.95 including vat



**PCW PRINTER RIBBONS**

We Stock Em! You Use Em! £4.17 Each (min. Order 2)  
plus vat



**ELECTRIC STUDIO MOUSE**

Mouse And Software Makes Artwork For PCW Easy! A Real Gem! £109.52 plus vat

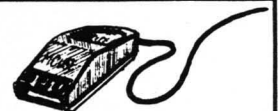

**CF2 3" DISKS**

**New Low Price!**  
£29.95 For 10 plus £1 p & p inc. vat  
£16.00 For 5 plus £1 p & p. inc. vat

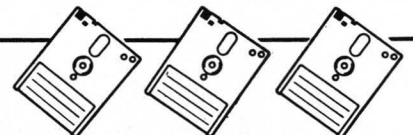

**NABITCHI COMPUTING**

**Merseyside Innovation Centre**

131 Mount Pleasant Liverpool L3 5TF  
Telephone 051-708 0123 / 051-708 8775



All prices are correct at time of going to press.

**ATTENTION - ALL PCW OWNERS.**

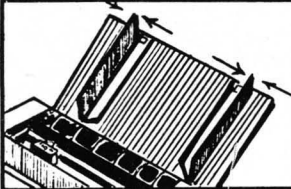

**Our New Paper Guide Replace's The PCW's Paper Tray And Put's An End To Bad Paper Loading. Sheet Feeder £12.95**  
including vat

**SOFTWARE (All software includes vat)**

EXBASIC.....£11.45  
FASTLY BECOMING THE BEST KNOWN GRAPHICS UTILITY PROGRAM FOR MALLARD BASIC (SEE GRAPHICS WITHOUT THE PAIN A.P.C SEPTEMBER 1986) EXBASIC IS IDEAL FOR DRAWING PYE CHARTS/PLOTS/GRAPHS ECT. (SAMPLES ISSUED ON THE SAME DISK)

ITSBASIC.....£7.95  
FOR ADULTS ONLY! 20 MALLARD BASIC PROGRAMS WHICH WILL GUARANTEE HOURS OF FUN. WITH USEFULL PROGRAMS LIKE ADDRESS BOOK AND STICKY LABEL PRINTER. (SEE 8000 PLUS REVIEW FEB 87 "PIRATES TREASURE" FIVE STARS OF VALUE!)

LOCA-PRINTER..(SOFTWARE ONLY).....£29.95  
LOCA-PRINTER..(INTERFACE UNIT).....£21.95  
LOCA-PRINTER..(SOFTWARE/INTERFACE)..£49.95  
WORKS DIRECTLY FROM LOCOSCRIPT TO ANY CENTRONICS/SERIAL PRINTER. OUR INTERFACE PLUGS INTO THE PCW'S STANDED PRINTER SOCKET THUS SAVING YOU BUYING THE AMSTRAD CPS8256 INTERFACE. (IT ALSO SUPPORTS THAT IF YOU HAVE ONE ALREADY!) LOCA-PRINTER HAS LOTS OF NEW FEATURES SEND S.A.E FOR INFO.

**WORDPROCESSING**

POCKET WORDSTAR DELUXE.....£59.95  
POCKET WORDSTAR.....£39.95  
LOCMAIL.....£35.95  
LOCOSPELL.....£35.95  
NEWWORD 2.....£59.95  
PROTEXT.....£69.95  
PROSPELL.....£25.95  
TASWORD 8000.....£19.95  
TAS-SPELL.....£15.50

**ACCOUNTS**

SAGE POPULAR ACCOUNTS.....£85.95  
SAGE POP/ACCOUNTS PLUS.....£125.95  
SAGE POP/ACC/SUP/COMBO.....£159.95  
SAGE POP/PAYROLL.....£53.95  
SAGE POP/INVOICING.....£53.95  
MONEY MANAGER.....£23.95  
MICRO SIMPLEX.....£89.95

**SPREADSHEETS**

SUPERCALC 2.....£38.95  
CRACKER 2.....£38.95  
MULTIPLAN.....£59.95  
SUPERCALC 3 (PC).....£69.00  
SCRATCH PAD PLUS.....£45.95  
POCKET CALCSTAR.....£45.95  
VP PLANNER.....£89.95

**LANGUAGES**

HISOFT C (PLUS EDITOR).....£35.95  
HISOFT PASCAL80.....£35.95  
HISOFT DEVPC 80 (ASM).....£35.95  
DR CBASIC COMPILER.....£42.95  
DR PASCAL MT+.....£42.95  
NEVADA COBOL.....£35.95  
ANSOFT FORTH.....£25.95

**DATABASE**

CONDOR 1.....£79.95  
dBASE II.....£95.95  
DELTA 1.25.....£79.95  
CARDBOX.....£48.95  
CAMBASE.....£48.95  
AT LAST.....£28.95  
FLEXIFILE.....£45.95  
SAGE RETRIEVE.....£59.95

**GRAPHICS**

DR DRAW.....£45.95  
DR GRAPH.....£45.95  
POLYPRINT.....£26.95  
POLYTYPE FACES (EACH).....£17.95  
PLOTYPLOT.....£22.95  
FULL POLY SERIES.....£49.95  
EXBASIC.....£11.45

send a S.A.E. for catalogue

# The ultimate choice in computer supplies for Amstrad Computers

## THE "NEAT-N-TIDY" SOLUTION FOR THE PCW 8256/8512

No risk  
Trial offer  
7 day money back guarantee

**£39.95**



"Tidy" is a PCW stand that puts your screen at eye level. It provides space for your keyboard and has a shelf for storing of disks etc. It can be locked to ensure security and privacy. Since the keyboard can be safely stored away when not in use extra desk space is then made available. Slotted in the top to connect the keyboard cable to the PCW.

THE TOTAL  
PACKAGE ONLY  
**£74.95 INC.**

NEW

**£44.95**

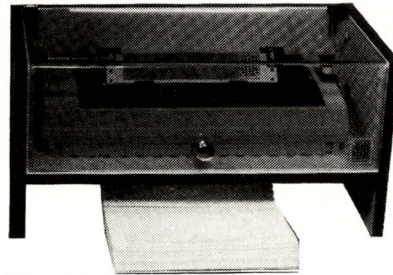

"Neat" is a printer stand and acoustic cover combined. No more annoyance to colleagues at work or at home. Designed to handle both continuous and sheet fed paper with slots at rear and top.

Available separately or as a pair for an unbeatable price, another new value for money product from SBS, the ultimate choice.

## TOP QUALITY ★ NO EXTRAS TO PAY ★ BEST PRICES

### 3" CF2 DISKS

£25.50 for 10  
£69.50 for 30

BEST  
PRICES

### 5 1/4" PC1512/DISKS

PLAIN LABEL  
IN PLASTIC CASE **£10.17** incl. for 10  
MAXELL  
BRANDED ..... **£13.60** incl. for 10

### DISK STORAGE



◀ DIAL A DISK  
10 x 3" DISKS  
PROTECTED AND  
DISPLAYED  
**£5.95 incl.**

3" DISC BOX  
HINGED LID ▶  
Cap 25 Discs  
(uncased) 15 cased  
**£9.50 incl.**



NEW

### "THINGI" COPY HOLDER

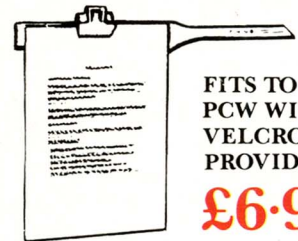

FITS TO TOP OF  
PCW WITH  
VELCRO STRIP  
PROVIDED.

**£6.99** incl.

PLEASE SPECIFY LEFT/RIGHT REQD.

### PERSPEX VDU FILTERS FOR PCW 8512 & PC 1512

- ▶ REDUCES EYESTRAIN
- ▶ REDUCES GLARE
- ▶ REDUCES HEADACHES
- ▶ IMPROVES CONTRAST

ONLY  
**£14.95** incl.



NEW

FITS TO VDU WITH VELCRO PADS PROVIDED  
PLEASE SPECIFY IF MONO/COLOUR VDU (PC 1512 ONLY)

DUST COVERS	PCW 8256/8512	Full set	£10.35
	PC1512	Full set	£9.50
RIBBONS	PCW 8256/8512/DMP 2000/3000		£4.95
	PCW 8256/8512 (Carbon)		£5.50
	DMP 4000		£8.03
LISTING PAPER	11" x 9 1/2" 60 gsm ruled/plain		£14.24/2000
	A4 continuous 70 gsm plain		£9.64/1000
	A4 continuous 90 gsm plain		£12.89/1000
	(Micro-perforated on all 4 edges)		
LABELS	3 1/2" x 1 7/16" 1 across the web		£31.56/8000

▶ Call for sizes not listed.

BARGAIN  
CORNER

## ALL PRICES INCLUDE VAT — PLUS — FREE NATIONWIDE DELIVERY

SBS Computer Supplies Ltd.

UNIT 3 · CLARKS INDUSTRIAL ESTATE · NEWTOWN ROAD  
HOVE · SUSSEX · BN3 7BA · TEL (0273) 726331 TELEX 878226

COMPANIES  
WHY NOT  
ASK FOR OUR FREE  
64 PAGE CATALOGUE

FOR IMMEDIATE DESPATCH ☎ OUR 24 HOUR



HOT LINE (0273) 726331

PLEASE SEND ME	DESCRIPTION	QTY.	VALUE
	TOTAL ORDER VALUE		

I ENCLOSE A CHEQUE PAYABLE TO  
SBS Computer Supplies Ltd.

NAME \_\_\_\_\_

ADDRESS \_\_\_\_\_

TEL \_\_\_\_\_

LARGE STOCKS  
AVAILABLE  
ACCESS AND VISA  
CARDS ACCEPTED

8000+

COMPUTER  
SBS  
SUPPLIES

# BEATING BIG BROTHER

The Data Protection Act gives you obligations and rights. Do you know what they are?

**C**omputers are very good at storing and retrieving data. The chances are that your name is held on dozens of computers throughout the country – credit card companies, the AA or RAC, and many local clubs all keep their membership records on computer.

Computers not only store data, they make its manipulation much easier. Different computers can swap details on you at the drop of a telephone, and if your details have been noted down wrongly, it is extremely hard to correct the data in every place it has reached. This can be a serious problem if, for example, you have been mistakenly labelled as a bad credit risk by your credit card company – you could find yourself being refused insurance and mortgages for no apparent reason.

To try to regulate this situation, the government has introduced the Data Protection Act. This obliges everybody who uses personal data on computers to register their use, and equally tries to ensure that individuals have some control over what data is held about them where.

The idea is that if you hold any information on a computer which can be linked to a specific living individual, then you must register your use of that data. That is to say, if you are storing letters with the addressee's name and address, or a list of customers with the products they have bought in the past, or anything which names names, you must declare it.

## Do you or don't you

Not all computer users have to register under the act. If everybody who owned a home micro filled out an application, things would get ridiculous. So there are certain exclusions to the act. Firstly, if you use your computer solely for personal, family or household affairs, then you are exempt and need not register. Two other exemptions are mailing lists and accounts. You can hold lists of names and addresses, as long as that is *all* there is – no history of customer purchases is allowed without registering it. As an employer, you don't in theory have to register your company payroll and accounts, unless you intend to make that information available to other people. In practice, most payrolls and account systems *are* registrable because they usually hold more than the bare details of names, dates and amounts, and so aren't exempt.

If you run a local club, you can keep your membership records on computer without registering, as long as every member knows about this and none of them object. You only have to register personal data on people who are alive. For example, you don't have to register genealogical records, or the list of people you have recently murdered.

Many PCW owners originally buy a machine for home

use and gradually begin doing more and more with it as they realise its power. As soon as you start to use it for business, even if it is only to help sell your vegetable garden surplus, you may have to register.

Bear in mind that being registered under the data protection act isn't like having a driving licence – you don't get a *carte blanche* to process any data you feel like. Instead, you have to register each individual type of processing that is covered by the act. If you begin using your PCW for a new (and registrable) use later on, you must register that too. Registrations for any purpose only last for three years, after which you have to reapply.

## Your rights

If you are a 'data subject', as the act calls people who have data held about them, you have certain new rights under the act. These rights will be legally enforceable from November 11th 1987.

If you know that an organisation holds data on you, you can (from November) legally demand to see the relevant data. The company is obliged to reply within 40 days of your written request, but they may charge a fee for doing this. The maximum fee hasn't yet been fixed, but is likely to be £10 or more.

But here is the big loophole in the Act: as a data subject, how do you know who holds information on you? There is no answer to this. You can go to public libraries and ask to see the Data Protection Register, which will be on microfiche. This tells you which companies use what kinds of information (if they have registered!) so you can make an informed guess as to whether they might have details on you. If a company does have details on you, they aren't obliged to tell you if they have passed them on to anybody else.

Credit card companies are slightly special, since they are largely covered by the Consumer Credit Act of 1974. They are covered by the new act too – the Data Protection Act is supposed to plug any loopholes in the Credit Act.

There are exceptions to your right of access. You aren't entitled to see your police or tax records, or most government bodies' records.

The Data Protection Act seems a well-intentioned attempt to give individuals more control over the ever-growing mass of information stored and used about them. It is the law of the land, and you are therefore obliged to follow it.

In practice, the Act is largely unenforceable. The sheer number of data users means that it would need a department the size of the Inland Revenue to police the act, and most of the important data in the country (like government and police records) are exempt anyway. Still, the fact that the government has realised the problem is a good sign, and hopefully some more realistic legislation will appear over the coming years.

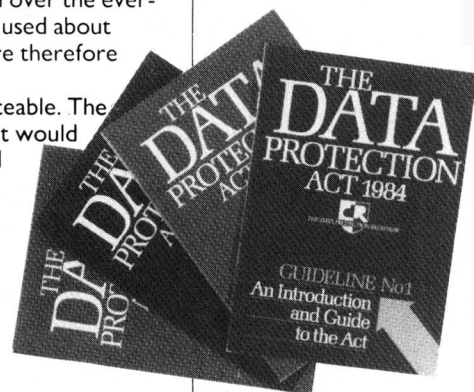

## Do they mean us?

To help people understand the Act, a series of booklets has been produced. These are fairly free of computer and legal jargon, and should be a useful read. There are two pamphlets of questions-and-answers.

Inevitably there will be cases of uncertainty, where you aren't sure if the act applies or not. There is a Data Protection Registrar, currently Eric Howe, whose job it is to ensure that all

the rules are being correctly enforced and to arbitrate in cases of uncertainty.

Unless you are absolutely certain that the act doesn't apply to you, you ought to get an information pack and registration form. Either write to Enquiries Department, Office of the Data Protection Registrar, Springfield House, Water Lane, Wilmslow, Cheshire SK9 5AX, or phone 0625 535777.

## MICRO-PLUS CASHBOOK £39.95 (£6.95 demo version) • Micro-Plus • 0424 224355

There are two ways of tackling accounts on the PCW. Buy a package that does everything except post the completed books to the auditors, or buy a simple system that just keeps track of your figures.

The main advantages of the second system are that while it stops your accountant having a nervous breakdown when you bring in a shoe box full of dog-eared receipts, you can run it without a degree in accountancy or computer science.

In their new Cashbook Analysis System, Micro-Plus have tried to produce a 'fool-proof' simple system that will allow a small business to handle 'the books' and keep track of the financial situation. You can call up a list of entries from the Cash Book and Unpaid Bills Account, display a bank reconciliation statement, VAT information and even knock out a trial balance with little effort. The trial balance even prints out the percentage of revenue and expenditure that each expenditure represents – won't that impress the bank manager.

It works on a system of Nominal Headings; that is to say when you want to tell the computer you have spent money on petrol, you type the appropriate Nominal Heading number. Micro-Plus has provided quite a comprehensive list of headings which should suit most needs but with the built-in flexibility of allowing you to add or change these headings, up to a total of 80 entries.

There are 15 Nominal Headings entries given over to where income has originated and there are nearly 100 sections that can hold the names of suppliers of goods to be resold or worked into finished goods.

Of course this could cause total confusion while you are getting used to whether Somerton Llama Meat Traders plc is number 156 or 157. There is no 'find' facility to look for a specific name although you can call

up a list on screen. It is more practical to print out the list and keep it beside you.

One major plus is that the program has worked out a system for dealing with mistakes once they are on disc – a feature often missing in accounts packages. You merely repeat the entry exactly except putting a minus before the figure. In the next entry you put in the correct details.

```

MICRO-PLUS - VAT CASHBOOK PERIOD 1 140387-1.1
-----
TRANSACTION NO. 26
1. NOMINAL CODE 35 - *ENTERTAINING
2. REFERENCE 9000+
3. AMOUNT 450.23
4. PAY METHOD UNPAID
5. ZERO RATED 0.00
6. VAT AMOUNT 58.72
   STD/RATED AMOUNT 391.51
CASH = 716.63 BANK = 531.15 UNPAID = 450.50
-----
904 - ENTER LINE NO. (1-6) TO AMEND OR (A)CCEPT (R)EJECT
    
```

The weakest feature must be the limited amount of reference space that each entry is given. Although you are asked to enter the date as you enter the program that is the only interest paid to the passing of time – a tragic lack when you are trying to keep track of unpaid bills, for instance.

The only way you can call up details seems to be using the 'transaction number'. This is an eminently forgettable detail, and with the sad lack of references could cause any number of headaches when you go back to look for a specific piece of information.

A final oddity is that Cashbook alters your keyboard so that it can only produce upper case letters. You will have to reset the PCW later on to be able to get lower case again!

In many ways the Cashbook lives up to its promise although with enough quirks to leave an unsettled feeling.

**RANGE OF FEATURES** ■■■■□ **PERFORMANCE** ■■■■□  
**EASE OF USE** ■■■■□ **DOCUMENTATION** ■■■■□  
**8000 PLUS VALUE VERDICT** ■■■■□

## UNIVERSAL SELF-START £19.95 • Cornix Software • 0462 682989

There are two types of PCW user – those that want to see what unlikely feats they can get it to perform and those that want to use it without having to bother about how it works. Cornix Software obviously have the second category in mind with their Universal Self-Start.

It allows you to take any commercial software package and produce self-starting discs, so you can load a program by switching on and inserting the correct disc. Cornix admit that you can perform these tasks using CP/M utilities provided free with the PCW – if you can understand the CP/M manual it is not an onerous task to knock up a quick PROFILE.SUB file to do this anyway.

But Cornix reckon there are plenty of people with A>-phobia out there. Also, for someone who wants their PCW to be used by a third person who is not really computer literate, the very fool-proof nature of the starter file might prove an advantage.

The program runs like the kind of installation program

you find bundled with some commercial programs. You are told, in simple terms, how to put the system files and SUBMIT.COM on to your starter disc. You run 'Instal' and it elicits the answers to a variety of questions regarding screen size (full or 24x80), whether you need single sheet or continuous paper (and sorts out the size) and winds up with a full choice of printer commands (Elite/Pica, normal/italic type, draft/NLQ and single/double strike).

Even if your application program doesn't need a modified screen or printer, you still have to answer all the configuration questions. It won't deal with copying your files to the M drive for speedy use, nor will it help you defining a SETKEYS file.

You have the choice of putting the Start program on your program disc or making a separate starter disc. As the Start program actually takes up 14k of space on the disc this might be necessary in some cases.

When run, the Start program will insist that you load the correct disc for the required program and rejects all others – an advantage when your PCW is being used by someone not used to the machine.

At the end of the day you have to decide whether or not you really need a self-starting disc and whether you wouldn't be able to produce your own Profile.Sub file – a not impossible task. Then you have to decide whether you are prepared to pay £19.95.

**RANGE OF FEATURES** ■■■■□ **PERFORMANCE** ■■■■□  
**EASE OF USE** ■■■■□ **DOCUMENTATION** ■■■■□  
**8000 PLUS VALUE VERDICT** ■■■■□

LocoScript user. . .



Instead of this . . .

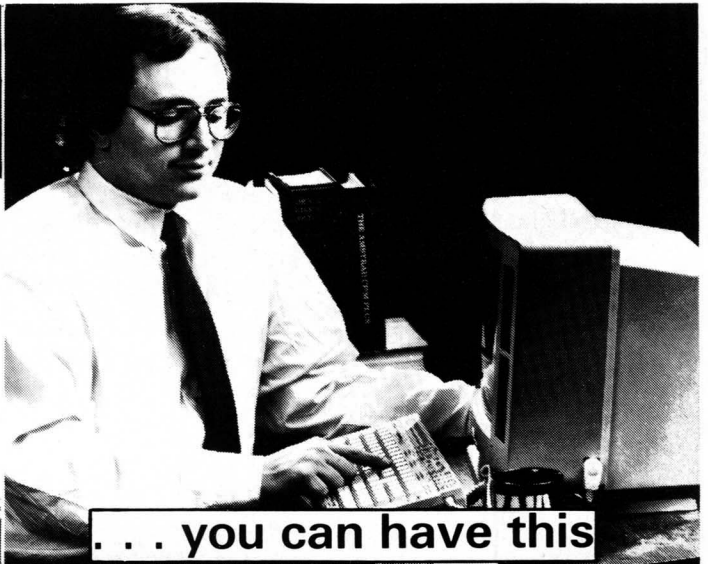

. . . you can have this



£6.99

## MENU-MATE™ . . . THE FACTS AT YOUR FINGERTIPS

Never forget another command with Menu-mate™ Templates to remind you. Save time and end frustration because commands and simple instructions are at your fingertips for quick and easy reference.

Richman Software's Menu-Mate™ is easier to use than books or reference cards, the facts are complete, properly organised to help you and available at a glance.

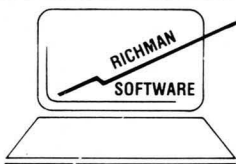

The first in a range of keyboard templates for popular micros and software.

PATENT APPLIED

Select options instantly, by-pass the menus. Why press six keys when two will do the same job?

See the exact appearance of your letter as you type it . . . no more guesswork.

Throw away the manual! Menu-Mate™ gives simple instructions on cutting, copying and pasting blocks and phrases for instant reference.

Never lose work because it wasn't saved. Menu-Mate™ acts as a constant reminder and shows you how!

Shows special features of LocoScript almost unknown.

PCW is a trademark of Amstrad plc  
Locoscript is a trademark of Locomotive Software.  
Menu-Mate is a trademark of Richman Software

Menu-Mate™ is precision cut to fit the PCW Keyboard exactly. This allows stability and easy removal.

Special introductory price of £6.99 + p&p includes free LocoScript guide.

Generous discounts available for bulk purchase.

Call for quantity discounts or quotations on custom made templates to meet your special needs.

ORDER NOW ON THE FORM BELOW AND KEEP THE JOY IN YOUR JOYCE!

Please make Chq/P.O. payable to:  
Richman Software, 14-16 Little Walk, Harlow,  
Essex, CM20 1HY. Tel: (0279) 25401.

Please send . . . . . Menu-Mate®/s at £6.99 + £1.25 p&p to:

Name: .....

Address: .....

Overseas add £4.00 p&p payable in Sterling.  
Allow 21 days delivery  
Major credit cards accepted

8000 PLUS

**SAVE UP TO 25%**  
ON BUSINESS SOFTWARE

DIGITAL RESEARCH ★ COMPUSOFT ★ COMPACT  
MIGENT ★ SAGESOFT ★ AMISOFT ★ & MANY OTHERS

# SUPER DISCOUNTS ON AMSTRAD PC & PCW SOFTWARE

For the program you want, try us first

EXAMPLES: TOO MANY TO LIST THEM ALL!

Sage Chitchat PC	£96.77
Compsoft Delta 4	£74.96
Volkswriter Deluxe	£35.99
Migent Ability	£88.80

Prices inc. VAT & P&P

OFFSHORE SOFTWARE SUPPLIES  
3 STRANMILLIS PARK, BELFAST, BT9 5AU.

**(0232) 669233**



Payment by ACCESS or VISA card welcome.

**OFFSHORE SOFTWARE SUPPLIES**

## THE BBD DUST COVER COLLECTION

Tailored in nylon fabric that has been treated with an anti-static inhibitor. Attractively finished with contrasting piping. Can be washed and ironed.

**PCW 8256/8512 £11.95**

3 piece set in soft grey. Monitor and printer piped in green. AMSTRAD PCW hot foil printed on keyboard.

**PC 1512 £8.50**

2 piece set in ivory coloured nylon. Monitor piped in maroon. AMSTRAD PC hot foil printed on keyboard cover.

**TIMATIC HARD DISC £9.50**

1 piece cover in light grey nylon, piped in green to cover monitor and keyboard. Matching printer covers also available.

### PRINTER COVERS TO MATCH

A range of covers for over 200 printers to match any of the above covers eg. Amstrad 2000 and 3000, Brother, Canon, Citizen, Epson, Mannesmann, Star, Ricoh, Smith-Corona etc. Prices start from £4.50

Please make cheques payable to:

**BBD DUST COVERS**

The Standish Centre, Cross Street  
Standish, Wigan WN6 0HQ

Telephone: 0257 422968

DEALER ENQUIRIES WELCOME



Available in the Southern Hemisphere from TECH-SOFT  
324 Stirling Highway, Claremont 6010  
West Australia. Tel: (09) 385 1885

## SERIOUS WRITERS ONLY!

If you are writing a book, thesis, scientific treatise, report, or any other text that requires an accurate index, our program AnsibleIndex is what you need. It is the *only* indexing software available for LocoScript.

Here are the main features:

- Up to 1,500 different entries
- Automatic alphabetization
- Exact page numbers
- Lists words, phrases and inverted phrases
- No special commands to learn...if you use LocoScript, you can compile an index
- Full page proof compatibility: optional dummy format, plus reorganization to match printed book
- AnsibleCheck included - see below
- Price: £49.50 (incl. VAT & carriage)

We also supply the only trouble-free LocoScript word counter, AnsibleCheck:

- Counts words as words (no estimates)
- Simple to use...one command runs the program, automatically
- Works with ordinary LocoScript files...no special preparation
- Also seeks (and shows in context) any words that have been repeated
- PRICE: £19.50 (incl. VAT & carriage)

Both packages include a special "extra": the dreaded GREASE, scourge of writers everywhere.... A comprehensive manual in plain language (author: 8000 PLUS columnist David Langford!) is included with both packages.

Ask for our brochure, or order direct, payment enclosed:

### ANSIBLE INFORMATION

(Dept. 8002) • 94 London Road • Reading •  
Berkshire • RG1 5AU  
Tel: 0672 62576



# The 64 Software Centre

1 PRINCETON STREET, LONDON WC1R 4AL - TEL: 01-430 0954

## Amstrad Software (PCW8256/8512)

### ACCOUNTS

Sage	-	Popular Invoicing .....	60.00
		Popular Payroll .....	60.00
		Popular Accounts .....	90.00
		Super Combo (Accts, Invoicing, Payroll) .....	180.00
Camssoft	-	Invoicing .....	45.00
		Payroll .....	45.00
		Stock control .....	45.00
		Sales ledger .....	45.00
		Purchase ledger .....	45.00
		Integrated accounts .....	135.00
Sandpiper		Accounting System .....	120.00
Advance	-	Money Manager .....	29.00
Map	-	Stock control .....	49.00
		Payroll .....	49.00
		Integrated accounts .....	135.00

### DATABASES

Advance	-	Database Manager .....	29.00
Amssoft	-	Microfile/Microword .....	45.00
Camssoft	-	Database .....	45.00
Caxton	-	Cardbox .....	55.00
Database	-	Plan it .....	24.00
Sage	-	Magic Filer .....	60.00
Sandpiper	-	File Manager .....	90.00

### WORD PROCESSORS

Tasman	-	Tasword 8000 .....	24.00
		Tasprint .....	14.00
		Taspell .....	16.00
		Protext .....	79.00
Arnor	-	Prospell .....	29.00

### SPREADSHEETS

Caxton	-	Scratchpad Plus .....	59.00
Amssoft	-	Supercalc 2 .....	49.00

### AIDS & UTILITIES

DR	-	Draw .....	45.00
		Graph .....	45.00
Caxton	-	Touch'n go typing tutor .....	24.00
Mirrorsoft	-	Graphics Operating System .....	99.00
Electric Studio	-	Light Pen & Graphics Program .....	79.00

### EDUCATIONAL

FSC	-	Magic Maths .....	12.00
		Maths Mania .....	12.00
		Better spelling .....	12.00

### GAMES

Leisure	-	Scrabble .....	19.00
Domark	-	Trivial Pursuits .....	19.00
CDS	-	Colossus Chess .....	15.00
FPS	-	Annals of Rome .....	24.00
Rainbird	-	Pawn .....	24.00
CPS	-	Bridge Player .....	19.00
Infocom	-	Hitchhikers Guide .....	24.00
		Trinity .....	34.00

All prices include VAT - Add 2.00 for P&P (UK and Europe). Add 20% for other countries.  
Software is not sold on a trial basis. Software sold by mail order in the UK may be returned within 7 days of receipt, provided that it is not damaged, marked or soiled and any seals are intact, in which event the purchaser may claim a refund.



Credit Cards (Visa/Access) telephone orders accepted  
Hours 10.00 am/6.00 pm (incl Saturdays)



# SECOND CLASS MAIL

Rummaging further through the lost treasures of the PCW master discs, Ben Taylor finds some free communications software.

**T**he master discs that come with the PCW have a veritable hoard of free goodies stored on them to please CP/M users. This month, the spotlight falls on side 1 of the discs.

Hold on! Isn't side 1 the LocoScript disc? True enough, but in proper Amstrad style there is a useful CP/M file hidden in amongst the LocoScript files. This file is called MAIL232.COM, and is a program to send information to, or receive from, the big world outside the PCW.

In short, MAIL232 is a piece of comms software. If you have read this month's Communications article, you will know what comms can do. MAIL232 can control a modem and so give you access to Telecom Gold, and to other computers with similar setups.

If you are going to use comms services often, you may tire of MAIL232 after a while. It lacks polish and friendliness, and it can't be used to access Prestel. However, for occasional users of Telecom Gold and other 'electronic mail' systems, it is quite good enough, and saves you spending £50 on special software until you really need it.

## It's free, except ...

Before you start, you will need to have a 'serial interface' unit such as Amstrad's CPS8256. This is a box which slots onto the back of the PCW, over the expansion socket. Serial interfaces are sometimes called 'RS232' interfaces, which explains the enigmatic '232' at the end of MAIL232's name.

To run the program, boot up CP/M normally and wait until you get the usual A> prompt. Now put your copy of side 1 (the LocoScript side) of the master discs into the drive and type MA I L 2 3 2 [RETURN].

The program uses LocoScript-style menus, although there are subtle differences in the way they work. Across the top of the screen you will see a menu bar, where [f1],

[f3], [f5] and [f7] are all listed. Pressing one of those function keys will bring a menu down, and the cursor keys with  $\leftarrow$  and  $\rightarrow$  make the settings. Press [EXIT], not [ENTER] as per LocoScript, to clear a menu away.

The first thing you do with any comms program is to set up the line speed, parity and so on. This is done with the 'framing' menu of MAIL232.

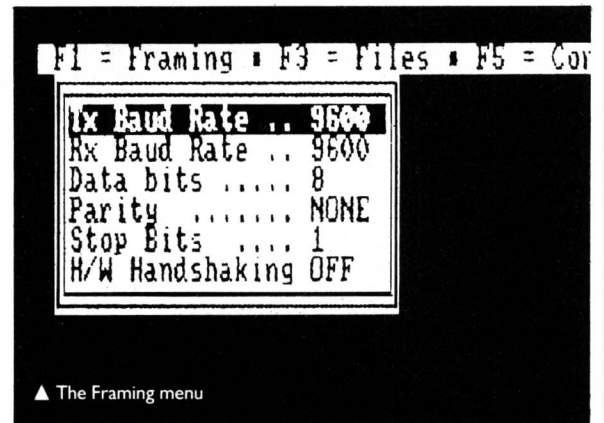

Press [f1], and the menu drops down. Use the cursor keys to get to the choice you want, and then as you press  $\leftarrow$  and  $\rightarrow$  the settings will be changed on the menu for you. When they are as you want, press [EXIT]. You will have to find out what the correct settings are by asking the person or system you're trying to connect to – the sender's and receiver's settings must be identical.

When you have set up, get your modem running and dial the service you are going to use. You can now type away; if you have set the speeds up correctly, everything you type will be sent to the other end of the line, and the replies will appear on the screen.

## Saving your messages to disc

Typing text in and reading the replies is all very well, but doesn't work for long messages. You want to be able to store long replies in files to print out and peruse later on; also, you want to be able to send previously prepared text files to avoid typing 20 pages of text while your phone bill ticks away.

The [f3] menu does this for you. Sending a previously prepared text file is the easier option: move the cursor to 'Send' and type in the filename. It must be a file on your currently logged drive, and you can't use names like 'B:FRED' to get to a file on drive B if you are logged onto drive A. When the name is correct, press [ENTER] to send it. Your screen will not necessarily show the file as it is transmitted.

To receive long messages, you type the name of the file in which you wish to save the incoming text in the 'Receive' slot. So type in all the commands needed for the host system (the one you've rung) to send the text to you, but don't press the crucial [RETURN] to start it

## Copying MAIL232.COM

The reason MAIL232.COM is on side 1 not side 2 of the discs is just space – side 2, with the rest of the CP/M programs, is full of other things.

It makes sense to transfer the file from your LocoScript disc on to your CP/M one. First, make sure you have enough room on your CP/M one by erasing some files if necessary. You probably don't use ED.COM much, so delete that.

MAIL232 is literally hidden on the LocoScript disc. In CP/M terms, it has been declared as a 'system' file, although you can run it normally, it will not show up on directory listings, nor will PIP copy it without a special command.

To copy MAIL232, you need to use PIP's [R] option. Assuming you're copying it from a disc on drive B to one in drive A, the command is

```
PIP A:=B:MAIL232.COM[R]
The [R] suffix tells PIP that MAIL232 is a system file. Now you can erase MAIL232 from the LocoScript disc, giving yourself an extra 4k of space there.
```

The new copy on the A disc will still be a system file. If you want to make it into a normal file (a 'directory' file) so that it will appear in future DIR listings, you must give the command  
SET MAIL232.COM [DIR]  
You will need to have the file SET.COM on your current disc.

transmitting. Press [f3] and set up the receiving option, and when you press [ENTER] MAIL232 is ready to receive. You are now back in 'chat' mode, so press the final [RETURN] to start the host's transmission. Any text that MAIL232 receives is now stored in the named file. Pressing [ALT]+[STOP] together stops the saving process and closes the file.



▲ The Files menu

There are two more function keys to be used, [f5] and [f7]. [f5] connects or disconnects MAIL232 from the communications line: use  to switch between the two states, and [EXIT] to finish. Being 'Online' means you are able to send and receive data, and being 'Local' means that nothing you type is actually transmitted. Local isn't a particularly useful mode to use.

Finally, the [f7] key covers two functions. The 'Return to CP/M' option is self-explanatory – just put the cursor over it and press [EXIT]. The other option on the menu, 'Z19/VT52 Emulation' is a little more obscure.

If you have ever worked with larger computers, like PDPs or VAXes, you will know that a standard kind of terminal to use with them is called a VT52. Z19 is a very similar terminal emulation, produced by a different company. With MAIL232 set to this mode, you should be able to use it as a terminal to one of these more powerful computers, which you might use at work.



▲ The Connect menu

MAIL232 is not a particularly sophisticated communications program, but it will just about do all the vital functions. As you come to use comms services more, you will find that buying some better software (such as that mentioned in our comms feature this month) saves a lot of hair-tearing.

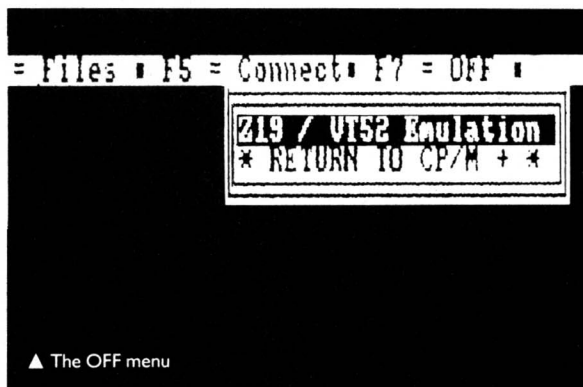

▲ The OFF menu

### Life! Don't talk to me about Life ...

Every computer has its little in-joke planted somewhere by the designers, and on the PCW it is to be found in the MAIL232 program.

'Life' is a mathematical game. The idea is that you have a colony of bacteria which are evolving over the course of several generations. In each new generation, some bacteria die and some are created. A bacterium dies of overcrowding if there are more than three other bacteria around it, and dies of loneliness if there are less than two neighbours.

A given bacterium will be alive in the next generation if it has exactly two or three neighbours. If an empty space has exactly three neighbours, then a bacterium is created in that space in the next generation.

So to 'play' Life, you set up an initial pattern of bacteria on the screen, and watch as the computer trundles through the generations. The idea is to find a starting pattern which does interesting things: it should grow, or move, or anything other than just die out, as most do.

What of MAIL232 in all this? If you bring up the [f3] menu, move the cursor to 'Transfer as ASCII' and press [EXTRA]+P, the screen will clear and prepare to play Life. Now use the cursor keys and the [RETURN] key to set up an initial pattern. When you press the space bar, the PCW will roll through the generations, until you press space again to stop it.

Have fun, and long may your bacteria divide.

EXIT

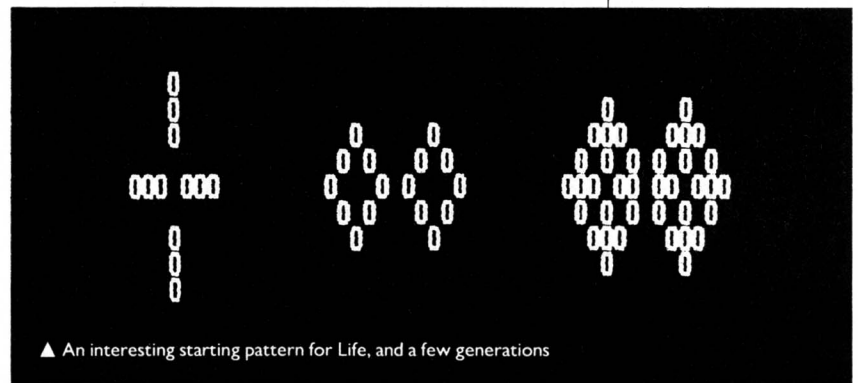

▲ An interesting starting pattern for Life, and a few generations

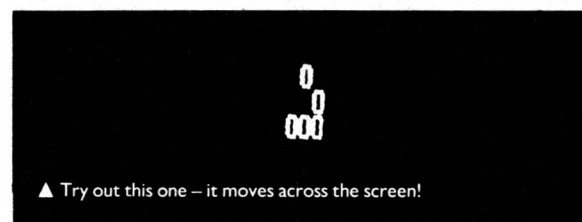

▲ Try out this one – it moves across the screen!

## Transferring .COM files

There is a final option on the [f3] menu, labelled 'Transfer as ASCII'. With the  key you can turn this to 'Transfer as HEX' and back. For sending text files, as you will normally want to do, don't alter this from the ASCII setting.

However, you can't normally transmit .COM files (or any 'binary' file) with MAIL232. This will never be a problem if you are just using Telecom Gold, but if you are connecting directly with a friend who wants to send/receive a .COM file (for instance to copy a file from a bulletin board) you will need to set to 'Transfer as HEX'.

This is only useful for transferring .COM files with other PCW owners, as it is only MAIL232 that uses this type of transfer.

If you do transfer files with the HEX option, once received they will need converting back into .COM format. To do this you will need to use the CP/M utility HEXCOM: edit any rubbish data out of the received file (suppose you call it FRED.HEX), and then the command  
HEXCOM FRED  
will create a runnable FRED.COM file from the FRED.HEX file.

# Suffolk Software

for the lowest prices you'll see anywhere. If you know what you want and how to use it, why pay more for PC or PCW software? (all PC products are for the PC1512™ and other compatibles) ?

## PLEASE STATE MACHINE TYPE WHEN ORDERING

*For the IBM PC and compatibles:*

Fleet Street Editor.....  
Low CostDesk top publishing £129  
Complete Guide to the PC1512 £19  
Ability1 integrated suite (Migent) £68  
Wordstar1512 from Amstrad £58  
Volkswriter deluxe from Lifetree £38  
Volkswriter 3 from Lifetree £148  
SuperCalc3 Release 1 s/sheet £58  
VP Planner: the 1-2-3 workalike £88  
Cracker3: ultimate spreadsheet £56  
FlexiCollection from Saxon £39  
Cardbox: the simple to use filer £48  
Conerstone: relational database £58  
Reflex: the Borland database £58  
dBASEII: Classic database £98  
VP Info: dbase3 compatible db £88  
Touch 'n Go: Typing tutor system £16  
Sage Accountant: basic accounts £68  
Compact (integrated) Accounts £138  
Camsoft Integrated Accounts £118  
MAP Integrated Accounts £118  
Homebase2: desk-top organiser £39  
SideKick (Amstrad only) £25  
Hitchiker's Guide to the Galaxy £18

*For the Amstrad PCW 8256/8512:*

LocoScript Audio Tutorial £6  
Pocket WordStar wp system £38  
NewWord2 with spell checker £58  
NewWord2 Audio tutor tape £6  
SuperCalc2 simple spreadsheet £38  
Cracker2 s/sheet and graphics £36  
MicroCollection: filer, wp, & labels £39  
dBASEII relational database£88  
Cardbox easy to use filer £38  
Brainstorm ideas organiser £38  
Cambase database system £38  
Touch 'n Go typing tutor £16  
Sage Popular Accounts £68  
Compact (integrated) Accounts £138  
Camsoft Integrated Accounts £118  
MAP (integrated) Accounts £118  
Companion desk top organiser £15  
Trivial Pursuit; Genus Edition£18  
Hitchhiker's Guide £19  
Classic adventure £10  
Polyprint typeface enhancement £23  
-Typefaces 2 & 3 (both) £32  
Polyplot: the graphing utility £18  
Flexilabel, the PCW label printer £18

## PLEASE STATE MACHINE TYPE WHEN ORDERING

Please note we sell only the big name publisher supported software. (Subject to availability) So we don't pretend to offer expensive and unnecessary end-user support

- hence the low, low prices. All prices include VAT and PP.

All offers applicable to the month of this issue only.

**Cheques and Postal orders only to**

**Suffolk Software**

**1 Well Lane, Clare, Sudbury, Suffolk CO10 8NH**

**I**t still bothers me how close I came to spending £3,500 on a combined word processing, data base and stock control system. Now in all fairness it must be said that for my hard earned pennies I would be buying an integrated system allowing word processing, text and file processing, accounting, forecasting and information systems to be developed using the same instructions and data.

The software would have been tailored specifically to my day to day business running requirements. The machine itself was a Transtec Z80A 8 Bit processor with 64K of random access memory, a twin disc drive each with 5 1/4" diskettes holding 2 x 400K characters and 8K read only memory, a separate qwerty keyboard, a 25 line x 80 character amber or green monitor and a Juki 6100 printer with various daisy wheels plus two days full instruction for the operator. Seems reasonable, you might think, if that's what you want and you can afford it.

Well affording it is another matter! I don't suppose I will ever know as the system would have been leased and in any case totally academic now as my company closed unable to support a workforce of ten and a 7,000 square foot factory. There is no doubt that had the computer system been in my hands twelve months prior to the closure things would have been very different. To maintain control of your business, however small, it is essential to know where you are and where you are going at any one time.

### If at first you don't succeed

Two years on I have restarted and totally restructured my company with only myself, my wife and an Amstrad PCW8512 running the company from an office at my home, with a turnover and profit exceeding that of my old company. With just a few weeks eyestrain and a SuperCalc 2 program I know exactly where my company is and I certainly know where its going.

It must be said that if this article is dedicated to anyone it must be the small business owners who think the computer, at the mere touch of a button, will transform their business and bring them instant success.

O.K. so I'm one of the fortunate few having a second crack at getting my business right I knew I had a good, saleable product but there was no point in retracing my steps trying to reform the company with a factory and staff. It hadn't worked the first time around, and the market hadn't changed so I saw no reason for it to work now.

The only sensible alternative was to contract the work out, providing we could maintain a reasonable and competitive price. This would of course eliminate the the biggest problem – overheads. As you can imagine, ten staff and a factory accrued an awful lot of expenses.

The next problem to overcome was administration, which wouldn't automatically disappear with the factory. The administration would still consist of innumerable replies to enquiries, orders to suppliers and invoices etc., so a typewriter was obviously essential. Stock control, accounting, book keeping and forecasting was likewise high on the priority list to ensure the success of the new company.

I knew that there were any number of microprocessors and necessary software on the market that would take care of my modest requirements. But which one should I go for, and more importantly how much would I need to spend? One thing was for sure at the outset, the computer system that was going to transform my original business, was financially out of reach even on lease.

Specialist magazines seemed the best course of action at the time, and bearing in mind that I had taken very little interest in computers for over two years I was

# SECOND TIME AROUND

Custom car connoisseur Peter Gowing has had his ups and downs in business. With the help of his PCW, he's made it good.



## Death of a salesman

**I am not a great believer in plastic credit but I just happen to have a Dixons credit card. So off I went to my local branch eager to find out more about this amazing machine ... almost end of story! Thirty long minutes after arriving at the shop, trying to gain as much information as I possibly could from the salesman, I hadn't learned a thing – tell a lie, I knew the price and that they had plenty of machines in stock.**

**Anyone who lives in the Southend area will know there are quite a few retailers of Amstrad equipment and I felt at this point my only course of action was to about turn and head for the nearest computer specialist, in my case Estuary Computers. Walking through the door was like a breath of fresh air! As soon as the salesman set eyes on me he knew I was 'brand new'. Undeterred by this he patiently listened whilst I explained the sort of miracles the computer was going to have to perform to make me a millionaire before the end of the year. I soon found out that if there were any miracles I was going to have to**

**perform them myself.**

**In fact, in this case the miracle would take the shape of the SuperCalc 2 software. I have to give the salesman his due; at this point he knew he didn't have any Amstrads in stock, and he knew I would therefore be buying mine elsewhere. He also knew that he could not match the credit facilities offered by Dixons at that time.**

**At this point I was draining as much information from this guy as I possibly could, with him fully acknowledging that I would almost certainly be purchasing my machine elsewhere. I think he would have been quite justified in asking me to leave there and then, but no, he continued to describe how my manual stock control system could be adapted for use on the 8256 by way of a spreadsheet, and carefully explained how it worked.**

**The least I could do was buy my software and back up discs from him. He realised that I wanted to get as much as I could from this machine and I am extremely grateful to him for advising me to purchase the 8512 with the extra memory capacity.**

# CASE IN POINT

	A	B	C	D	E	F	G	H	I	J	K	L	M
	MAR	APR	MAY	JUN	JLY	AUG	SEP	OCT	NOV	DEC	TOTAL		
6: NET SALES	7272	13830	11613	14016	16896	19878	11855	15615	17643	15435	144053		
8: MATERIALS	7215	2652	9414	16805	18087	12837	5311	8609	14217	11124	106271		
10: GROSS PROFIT	57	11178	2199	-2789	-1191	7041	6544	7006	3426	4311	37782		
12: BANK CHARGES	95	0	0	137	0	183	46	77	46	32	616		
13: STANDING ORDERS	194	194	194	194	194	194	194	194	194	194	1940		
14: ADMINISTRATIVE	333	6	44	392	57	15	323	29	102	221	1522		
15: PETROL /SUNDRIES	62	55	71	72	55	178	78	743	154	307	1775		
16: ADVERTISING	0	103	343	215	33	126	243	22	421	98	1604		
17: TELEPHONE	0	0	0	255	0	0	202	0	0	255	712		
19: TOTAL EXPENSES	684	358	652	1265	339	696	1086	1065	917	1107	8169		
22: PRE TAX INCOME	-627	10820	1547	-4054	-1530	6345	5458	5941	2509	3204	29613		

▲ With SuperCalc 2 you can see your business's state at a glance

	A	B	C	D	E	F	G	H	I	J	K	L	M
	MAR	APR	MAY	JUN	JLY	AUG	SEP	OCT	NOV	DEC	TOTAL		
6: NET SALES	0	0	0	0	0	0	0	0	0	0	0	SUM(B6;K6)	
8: MATERIALS	0	0	0	0	0	0	0	0	0	0	0	SUM(B8;K8)	
10: GROSS PROFIT	B6-B8	C6-C8	D6-D8	E6-E8	F6-F8	G6-G8	H6-H8	I6-I8	J6-J8	K6-K8	M6-M8		
12: BANK CHARGES	0	0	0	0	0	0	0	0	0	0	0	SUM(B12;K12)	
13: STANDING ORDERS	0	0	0	0	0	0	0	0	0	0	0	SUM(B13;K13)	
14: ADMINISTRATIVE	0	0	0	0	0	0	0	0	0	0	0	SUM(B14;K14)	
15: PETROL /SUNDRIES	0	0	0	0	0	0	0	0	0	0	0	SUM(B15;K15)	
16: ADVERTISING	0	0	0	0	0	0	0	0	0	0	0	SUM(B16;K16)	
17: TELEPHONE	0	0	0	0	0	0	0	0	0	0	0	SUM(B17;K17)	
19: TOTAL EXPENSES	SUM	SUM	SUM	SUM	SUM	SUM	SUM	SUM	SUM	SUM	SUM	SUM(M12;M17)	
	B12:B17	C12:C17	D12:D17	E12:E17	F12:F17	G12:G17	H12:H17	I12:I17	J12:J17	K12:K17			
22: PRE TAX INCOME	B10-B19	C10-C19	D10-D19	E10-E19	F10-F19	G10-G19	H10-H19	I10-I19	J10-J19	K10-K19	M10-M19		

▲ SuperCalc showing the formulae used to generate the cash analysis

## Are you a case?

Has your PCW revolutionised your life? Traumatized it? 'Case in Point' is a regular feature of 8000 Plus, and we are always looking for readers with interesting experiences to relate. If you use your PCW for something more than just running LocoScript, why not share your thoughts with a waiting world?

Try to keep things light but specific, with a fair smattering of hard facts

about the packages you use. If you've had a bad time with some software, don't be afraid to sound off - you could be saving other readers weeks of agony.

We are looking for articles of not more than 2000 words, for which we will pay our usual generous rates. Write to Case In Point, 8000 Plus, The Old Barn, Somerton, Somerset TA11 7PY

puzzled to find that almost every other page contained the word Amstrad. Surely these were the people who made cheap hi-fi systems and I didn't recall them having a particularly good reputation for reliability either. However, after reading several articles about microprocessors suited to the small business, and considering finances carefully, the Amstrad 8256 did seem to have the potential I needed.

So I went out to scour Southend for Amstrads and information. When I finally got home, I was like a kid with a new toy finding it very difficult to heed the Amstrad manual instructions to "wait do not plug in yet". Patience prevailed and my enthusiasm did not wane. For two weeks every evening, sometimes into the early hours of the morning and certainly during the day when possible, I would be tapping away determined to make this computer earn its keep.

During these few days my wife and I had mastered LocoScript, the wordprocessing software supplied with the 8000 series machines. We created templates to suit our previously printed letterheads, invoices and orders. Although the Amstrad printer doesn't achieve the high standards I had become accustomed to, it still outshines some leading electronic typewriters. The various print styles available, together with a little work designing templates and the results can be very professional.

During the twelve years of self employment owning a motor accessory shop, a garage and a company which manufactured two sports cars per week, I have never had a precise stock count - nothing to boast about I admit, but how many small businesses share my dilemma? I can now present my accountant, in about 60 seconds, with the value of my entire stock to the nearest penny at any time during the financial year. Costings can now, in a matter of minutes, be checked against the last invoice and updated.

Instead of waiting until the end of the year for my company performance figures I can readily check profit and loss at the end of every month. One of the most tedious and time-consuming tasks for any small business falls at the end of each quarter when columns of figures require totalling for H.M. Customs and Excise. Conveniently, each of my sales and purchase lists will now total at my command, separating the VAT from net and gross figures.

I refuse to grant Messrs Amstrad and the writers of SuperCalc 2 all the credit for my new found office 'superefficiency'. It has taken some eight months of mostly enjoyable and immensely rewarding hard work to reach the stage where my computer has replaced the staff I once relied on so heavily.

If there are any readers without any previous computing experience who are contemplating the purchase of a microcomputer for their small business TAKE NOTE: *there are no miracles and there is no such thing as 'at the touch of a button'*. You must be prepared either to attend one of the hundreds of courses around the country to learn how to use your micro or to pay for the ground work to be carried out by a professional in your home or office.

If you refuse to lay out several thousand pounds on an integrated package, there is only one option left open to you, and that is to slog through the software manuals. However, if you do not have the time or the inclination, you may as well just stick to your old pen and paper system. If, like me, you treat it as a hobby, looking forward to the next discovery as the machine improves the performance of your company, you and your business will never look back, *I promise.*

EXIT

## PAPER GUIDE FOR PCW 8256 & 8512

All inclusive **£9.85**  
No more to pay

Now you can load paper accurately and easily time after time. Essential for high quality presentation of your work. Set up the guide once and every page prints out with precisely aligned margins and text.

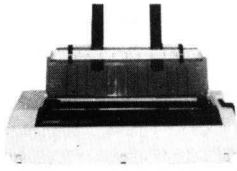

### WHAT THEY SAY ABOUT IT...

"...simple, well designed  
...extremely well constructed  
...the paper ends up every time more or less squarely at the ball bar. It's a good feeling.  
...for your money you not only get something instantly adjustable to any size of paper, but also something permanent and good looking to boot."  
AMSTRAD PROFESSIONAL COMPUTING  
MARCH 1987

Speeds up printing  
FITS SIMPLY ON THE  
AMSTRAD PRINTER

- U.K. manufactured from high quality nylon and satin finish alloy parts specially styled to match the printer
- inch scales in pitch 10 and pitch 12 aligned to screen layout
- markers to centre A4
- adjustable for any paper size
- speeds up printing

SEND CHEQUE / P.O. with order to:

**Chromodynamics Ltd.** TEL: 0625 58 5003  
NEWTON HOUSE, CHAPEL ROAD, ALDERLEY EDGE, CHESHIRE, SK9 7DX

## INCREASE 512K TO 640K FOR ONLY £19.90 PLUS VAT

18 off 4164-150ns 64K bit Dyanmic RAM why pay more when you can save money and fit them in minutes

MONEY BACK GUARANTEE IF NOT DELIGHTED

send **£24.50** to include VAT & P&P  
OTHER CHIPS

41256-15 £2.99 each 27128 £2.10 each supplied  
New catalogue only **£1.50**



**Microkit Ltd** 0536 744664

Dept 8000+ 18 Coldermeadow Ave Corby Northants NN18 9AJ

## AMSTAT

MODULAR STATISTICS AND MATHEMATICS PACKAGE

Marketed by

**S.C. COLEMAN**

Available for BOTH PCW AND CPC ranges

★★★★ NEW AMSTAT7 ★★★★★

**AMSTAT1 (V1.2)** - means, st. devs., variance, skew, kurtosis, 1-sample, 2-sample, and paired t-tests, 1-way-AOV with single and mult. conf. intervals, 2-way-AOV, correlns, regression, histograms, scattergrams, transformations, file store and retrieve, output to WP file, manual. Flexible variables and observations to a total of 500 (+) data points.

**AMSTAT2** - 27 nonparametric tests in 4 programs providing a "complete Siegel". Binomial, Chisquare(3), Kolmogorov-Smirnov(2), Runs, McNemar, Sign, Wilcoxon, Walsh, Randomisation(2),

Fisher, Median(+extension), Mann-Whitney, Wald-Wolfowitz, Moses, Cochran, Friedman, Kruskal-Wallis, Contingency, Spearman, Kendall, Kendall partial, Concordance.

"tremendous value" - Tony Kettle, Popular Computing Weekly, 8-14th May 1986

"I now give it an unreserved recommendation..." Jo Stork, Business Computing with the Amstrad, July 1986

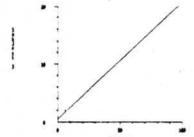
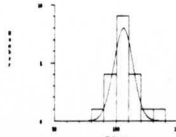

### AMSTAT3: FORECASTING

An array of business oriented mathematical and statistical software: Linear and Polynomial regression, Trend and Seasonal Variation, Multiple Regression Analysis, Transformations, Exponential Smoothing, Adaptive Filtering. Graphic display, full printout, manual suited to immediate use and for teaching.

### AMSTAT4: RESOURCE MANAGEMENT - LINEAR PROGRAMMING MODULE

General purpose Linear programming + Specialised Transportation and Assignment variants. Capable of analysing and solving problems of sequencing, scheduling, blending, and allocation of scarce resources. 40 page manual, 18 worked examples.

**AMSTAT6: SFANOVA** - Up to 8-way analysis of variance for equal cell sizes. Unequal cell sizes on 1-way AOV. Maximum of 2000 data points (300 on unexpanded CP/M 2.2). Input from ASCII Files. Output to screen or text file with full AOV table + main and interaction means and Newman-Keuls on main effects. Manual. (Disc only.)

### AMSTAT7: RESOURCE MANAGEMENT II - STOCK AND PRODUCTION ANALYSIS

Calculation of optimum re-order levels for both single and multiple items. Dynamic programming to calculate optimum production schedules for single items and consolidation of several results into a multiple schedule. Also Pareto and Lorenz analysis. Output to screen or printer. Includes operational manual with worked examples.

The programs have applications in research of all kinds, education, sales, production planning, work and method study, financial planning, personnel, social work etc.

Price list:	CPC	PCW	Price list:	CPC	PCW
AMSTAT1 v1.2	£25.95	£27.95	AMSTAT6	£25.95	£27.95
AMSTAT2 v1.0	£39.95	39.95	AMSTAT7	£25.95	£27.95
AMSTAT3	£25.95	£27.95	AMSTAT1+2	£49.95	£49.95
AMSTAT4	£25.95	£27.95	AMSTAT1+2+3+4	£99.95	£99.95

All prices include P&P within U.K.



+ 24 hours answerphone.

Cheques POs to

**S.C. Coleman, 33 Leister Road, Ashby-de-la-Zouch, Leics. LE6 5DA Telephone: 0530 415919**

# DIGITA INTERNATIONAL



PLAN YOUR OWN TAX WITH **PERSONAL TAX PLANNER** **£24.95** Inc. VAT and P&P

Make sure your taxman is doing his job correctly with Digita's Personal Tax Planner. Fully menu-driven, "PTP" is a U.K. income tax computation program which will calculate your income tax liability for a given tax year and provide pertinent facts about your tax position. Information, once entered, can be easily saved and amended and this can be used to provide useful "what if" calculations on your tax liability. For example, you could use PTP to see what effect an increase or change in allowances has on your tax liability.

Guidance notes are provided for users unfamiliar with the operation of the U.K. tax system. Nothing could be more simple! **NOTE: Software update service available for changes in legislation.**

"...very easy to follow and the calculations are accurate. If you need a ready-made program of this kind, it will certainly do the job."  
Amstrad Personal User, January 1987.

UP GRADE YOUR PRINTER

**Supertype** **£24.95** Inc. VAT and P&P  
Previously published as **FontGem**

Supertype will give you 8 radically different type faces, and will work directly with any of your software including Locoscript. **NOW LOCOMAIL / LOCOSPELL COMPATIBLE.**

"The program is menu driven and very easy to use. For the business user who just wants a different print style, possibly changing it occasionally, then FontGem (Supertype) is easily the best."

Popular Computing Weekly, 11th - 17th December 1986.

## SUPERNOVA SOFTWARE PRESENTS CLASSIC INVADERS

"Ideal therapy after a frustrating day using the PCW."

The Complete Guide to the Amstrad. **£13.95** Inc. VAT and P&P

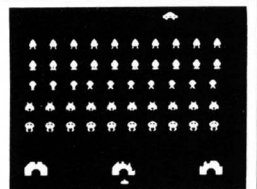

## DATASTORE - the professional database. **£39.95** Inc. VAT and P&P

Looking for fast access to stored data? Want to create customised reports, mailing labels, office and personal records with NO technical knowledge...? Researched, developed and written exclusively for the Amstrad PCW, Datastore will fully utilise the facilities of your computer. It makes an ideal partner for the novice or expert.

Some of the many features include:

- Menu-driven with prompts.
- Numeric, string, date and money fields.
- Full mathematics, + - × ÷ and average.
- Up to 4 user-definable keys (40 characters) for each file.
- 32,000 records, more with hard disc.
- 32 fields, 8 key fields.
- Lightning search feature - typically under 4 seconds.
- 1,498 characters per field.
- Uses M drive and A or B drives.
- 1 or 2 drives open at one time - allowing cross referencing between files.
- Fully supported printer options.
- 2 user-definable printing templates.
- Search on any field or combination of fields for any information.
- Optional conditional search facility.
- Uses full width of PCW screen.
- Facility to completely change the record layout after you have entered your data.
- Automatic calculations on entry particularly useful for VAT, etc.

### Can be used for:

- Mailing Lists
- Personnel Records
- School Reports ● Plant Records
- Order Forms ● Statistics
- Membership Records
- Customer Records
- Telephone Directory
- Job Cards ● Catalogues
- Stock Control

INCLUDES FULL TUTORIAL FOR BEGINNERS



**ORDER NOW ☎ (03954) 5059**

Please send me.....

I wish to pay by Cheque / P.O. / Access / Barclaycard.

I authorize you to debit my Access / Barclaycard with the amount £.....

Card No. ....

Name: .....

Address: .....

Signature: .....

Send to: DIGITA INTERNATIONAL Ltd., Kelsey House, Barns Road, Budleigh Salterton, Devon, EX9 6HJ.

# LocoScript 2

## Is here!

Proving that they really do listen to their critics, Locomotive Software have released a new, improved version of LocoScript. Ben Taylor measures it up.

**LOCOSCRIPT 2**  
**£19.95 • Locomotive Software • 0306 887902**

When Amstrad launched the PCW in late 1985, it was a unique machine in many ways. In particular, what was really being sold was not a computer but the wordprocessing software, LocoScript. The PCW itself was pretty much just a vehicle for that.

LocoScript, allied with the PCW's trusty disc drives, printer, screen and keyboard, suddenly brought the technology revolution to a whole band of people who thought that computers were thing that kids played with. Amstrad's advertising campaign, showing a skipload of junked typewriters, is probably pretty close to the mark – there are very few PCW owners who, used to typing and retyping drafts of documents, do not now have an ageing Olivetti gathering dust in a corner, never to see the light of day again.

In the 18 months that LocoScript has been around, the users have made plenty of suggestions as to what improvements they would like to be made. In general there has been a popular vote that it is ideal for quick letters, but has two major flaws: that it is very slow at moving around documents longer than a couple of pages, and that it can't use high quality printers.

Of course there are many other word processing programs for the PCW – WordStar, Tasword, Protex. All these programs work differently, and have features that are not to be found in their competitors. No word processor does *everything* that you could want, but will LocoScript 2 do well enough, or should you be looking elsewhere?

### Jump to it

LocoScript 2 has a key and menu structure based on LocoScript 1 but rationalised. The basic philosophy is that functions you need to do regularly are on odd-numbered function keys, and the lesser used one on even-numbered keys (you have to use [SHIFT] to get at them.)

One of the most welcome keys while editing will be the [f5]. In LocoScript 1, whenever you want to move to another part of your document you have to watch the screen scrolling through all the intervening text. Even with the [DOC] key, to go to the end of the document you must witness your previous life flashing (well, crawling) before your eyes.

LocoScript 2 has a 'jump to page' command. Press [f5], and you can now enter the number of the page to jump to. Any number between 1 and 999 can be entered – use '1' for jump to start of document, and if you aren't sure how many pages there are, use '999' to jump to the end. A short pause, the disc whirrs, and suddenly you are at the start of the specified page.

The version of LocoScript 2 we reviewed was still a pre-production version, but it would move through 10 or so pages of full text in around 5 seconds. The final release version is promised to work even faster. The [PAGE] and [DOC] keys still work as before, and the text scrolls by as the cursor moves. Even so, the scrolling is two or three times faster than in LocoScript 1.

This speed-up (two- or three-fold) goes right across the board. The Find/Exchange command works that much faster too, although it is still slow compared to Protex. When you [EXIT] and 'Finish Editing', LocoScript does not scroll to the end of the document, but finishes straight away. Also, 'Save and Continue' returns you to your current position rather than the top of the document. Unfortunately the 'Insert Text' command still scrolls through the text as it inserts, so it still seems slow compared to programs like WordStar/NewWord and Protex.

The reason that LocoScript (both versions) scrolls through text so slowly compared to other word processors is that it reads the text as it goes to make



▲ The LocoScript 2 editing menus – or most of the new ones anyway.

sure that it is correctly formatted on the page and on the screen.

With most wordprocessors, when you insert a word in a paragraph, you mess up the right hand margin of the page since you have changed a line length. You then have to give a specific reformat command, otherwise it will print out incorrectly.

LocoScript does all the necessary reformatting automatically as you move down through the text. Of course, if you haven't gone past page two of a five page document, LocoScript should realise that none of the text below page two will need reformatting. LocoScript 1 ignored this fact, but LocoScript 2 knows it doesn't need to read any of that text (and display it on the screen as it passes it) which is how the 'jump to page' command can work so fast.

When you do a jump, the only delay is to allow LocoScript to copy your disc document into its temporary workspace as it goes through it.

There is one minor side effect of the jump command which you ought to be aware of: the working of Layouts has altered subtly. In LocoScript 1, you could define several numbered Layouts, and insert them by their number at different points in the text. If you edited one of them, the changes you made applied to all occurrences of that layout throughout the document.

In LocoScript 2, when you edit a Layout, the changes only apply to that particular occurrence. This is so that the 'jump to page' command can skip large chunks of text without having to check to see if any Layouts used in that region have changed because of edits you made elsewhere. It also means that if you copy one document into another, the Layouts that the original used are copied across too, whereas in LocoScript 1 there were confusing results.

### A question of character

So to the other burning topic of interest – printers. The standard printer that comes bundled with the PCW has attracted some adverse comment, mainly from people who have never used other computers and seen how bad most dot matrix printout is.

For starters, people who don't own anything but the standard printer will still get a lot out of LocoScript 2. The printer font (ie. the actual design of the characters on the paper) has been redesigned to give some characters (the 'W' and 'M' particularly) a more natural look.

There is a whole range of new characters now available. The character set can cope with all European languages, except, as Locomotive shamefacedly admit, some parts of Tartar, Macedonian and Cyrillic Serbo-Croat. All the accents for Polish, Czech, Welsh and so on are available – there are 15 possible accent characters, any of which can be used with any character. Previously, only certain combinations of characters and accents were allowed.

New characters include a full Greek and Russian alphabet (although some of the aspiration accents in classical Greek are not supported), mathematical set notation, playing card suit signs, and many more. The full range is shown in the illustration. There are a few double height mathematical symbols, like integral signs, which will prove popular with students and others.

The printing of capital letters with accents has been changed so that the letter itself is not squashed down. With LocoScript 1, the E in E would be smaller than an ordinary E, because the accent had to take up some of the character space. Now the accent is printed higher up, and the letter itself is unchanged.

Finally, should this not prove enough, there is scope for you to define up to 10 characters of your own design. Character definition is difficult, and you will need to get

## What are your choices?

If you use LocoScript 1 at the moment and you are unhappy, you may be thinking of buying another wordprocessor. In the past, the two most common reasons for buying another word processor were to be able to move around large documents quickly, or to be able to print out on higher quality or faster printers. LocoScript 2 solves both these problems. There are two arguments for not using LocoScript, and it's really up to you to decide whether they are important or not.

LocoScript does not run from CP/M. This means that if you use a database or spreadsheet, or any program other than LocoScript, you will have to reset

the machine. This loses the contents of the M drive, and takes about a minute to do which gets annoying after a while.

Secondly, you may want to use a spelling checker and a mailmerger with your wordprocessor. Most of LocoScript's competitors, although costing more, include these two extras in the price, whereas LocoSpell and LocoMail for LocoScript cost £39.95 each. In effect, to get a complete system of LocoScript 2, LocoSpell and LocoMail, the price is £99.85, which starts to make you think twice. Compare this to NewWord at £69, and Protex at £79.95.

special help from Locomotive in the form of an extra utility program to do this.

This bewildering range of characters can mean you have to use some weird combinations of [SHIFT], [ALT] and [EXTRA] to get them, but that is a small price to pay.

For those who have tired of the standard printer's efforts, you can now hook up a daisywheel printer (or another dot matrix printer) to your PCW when using LocoScript 2. You will need to buy an Amstrad CPS8256 serial/parallel interface before you can do this, which will set you back £65 or so.

Broadly speaking, any common printer will work with LocoScript 2. Specifically, any printer which is Epson compatible (dot matrix printers usually are) or 630 compatible (daisywheel printers usually are) will work. Check with your dealer before you buy. You may be interested to know that the range of suitable printers includes a few laser printers – the Canon LBP-8, Centronics PP-8 and Daisy M7001 – although these also have interesting prices!

In fact, any printer can be used with LocoScript 2. If it is not Epson or 630 compatible, you will have to write your own printer driver with a separate piece of Locomotive software.

The full range of LocoScript 2 characters is only available on the standard PCW printer. In particular, with a daisywheel printer you can't print anything not actually defined on the print wheel itself. However, LocoScript 2 automatically does some cunning overprinting tricks to produce accented characters such as the ones shown in the sample.

Tests showed that LocoScript 2 can usually print out to a Juki 6100 daisywheel printer at roughly the printer's maximum capacity. However, when you switch to 'high quality' mode, the Juki can drop to only 50% of its top speed of 18 characters per second when doing proportional spaced text.

Even daisywheel printers have a high quality and a draft mode: in high quality, the printer runs more slowly to allow the print head a longer settling time as it moves into position. For really accurate character positioning, which LocoScript 2 tries to do, this gives you surer character registration, but is slower. You can still use the standard printer (which you have free of charge anyway) for quick drafts, and then print a final version out on the daisywheel.

### Other goodies

Speed and print are the two main new features, but LocoScript 2 is packed with other surprises. ▶

### Printer types

**Dot matrix** printers (like the standard PCW printer) print characters as sets of dots, and the text can look a bit grainy close up.

**Daisywheel** printers work much like typewriters, and produce a crisper character.

**Laser printers** are effectively very high quality dot matrix printers, which combine daisywheel quality with dot matrix versatility. Laser printer cost £2000 or more, but the prices are coming down rapidly.

# LocoScript 3?

OK, so LocoScript 2 is only just here. Locomotive Software would probably not be pleased to see much speculation about LocoScript 3 at this stage!

Even so, there are a couple of omissions that Locomotive might like to look at in the future. First, of course, wordprocessors cannot work too fast. LocoScript still scrolls (as opposed to jumping) at a relatively low speed through text which needs no reformatting.

It would be nice to have bulk copying facilities on the disc manager menu.

For instance, if you have 20 files containing short standard paragraphs, you might want to copy them all to the M drive with one command.

Might LocoScript 3 be able to print text in multiple columns too? And probably a target for LocoScript 4, you would be able to switch to CP/M and back at the touch of a button, rather than having to reset the machine entirely. We live in hope.

Finally, please can we have a built-in word counter?

The good news is that you may never have to use CP/M again, and your days of running DISCKIT to format and copy discs are over. You can do all necessary disc housekeeping and preparation entirely from the LocoScript disc management menu in LocoScript 2.

The Find and Exchange functions have been changed a little. In the old version, you could type in a phrase or word to look for, but the search only worked if the case (capitals or lower case) of the text was right. If you looked for 'wombats' you would not find 'Wombats', for instance.

Now the case is unimportant, unless you specifically say. Further, you can include 'wildcards' in the search string. For example, if you look for '?a?ter' you will find either 'master' or 'barter', whichever comes first.

When you do an Exchange, you can match the case of the new text to the old text. So, if you want to change 'five' to 'six' throughout a document, and you specified that the letter cases should be matched, the occurrences of 'five' will be changed to 'six', 'Five' to 'Six' and 'FIVE' to 'SIX', all with the command.

There are a couple of little extras, like you can now print multiple copies of the same document from the Printer menu. Also, if you store long documents as sets of shorter ones (as you should) you can link their page numbers and layouts together so that when printed out they follow on from each other consistently. You can set up the [RETURN] key to produce any line spacing from 1 to 3, so that you can leave half-line spaces between paragraphs if you want.

The working of Blocks and Phrases has been changed too. You can now list out all the phrases you have available, to jog your memory, and the first few words of your blocks too. In the old LocoScript, whenever you left a document all the blocks you had set up were lost, but now they are all retained until you reset the machine. This means that, to copy a large chunk of text from one document to another you can COPY it into a Block, leave the current document, open the new one and PASTE the Block in.

The method of setting up your page layout has changed. You still have basically the same range of options in terms of where the headers and footers go, but the order in which menus appear has been rationalised. In LocoScript 1, headers and footers were a nightmare. You had to define a zone and a position for the header and footer, which allowed the header text to start on any line you liked within the zone.

The concept of header and footer positions has been abolished – if you want the text to start on a specific line, you just type blank lines into the header (or footer). You can also define two independent gaps at the top and bottom of the page to make printing on continuous stationery neater – these two replace the old single 'gap length' of a page, which was confusing since it wasn't totally clear whether the gap came at the top or bottom of the page.

You can give each new layout a specific name, like 'A5', or 'Labels' to remind you what it is for. When you come to print a document, LocoScript will check that the printer is set up to match what the document expects. If it doesn't, you have three choices: (a) use the printer's settings, (b) use the document's settings, or (c) none of the above.

Finally, one omission that is bound to cause an outcry (or shouts of glee from magazines who publish program listings, mentioning no names) is that there is *still no word counter in LocoScript 2!!!* Come on guys, a lot of LocoScript users write material which they get paid for by the word. We know that LocoSpell does this for you, but that costs £40 extra.

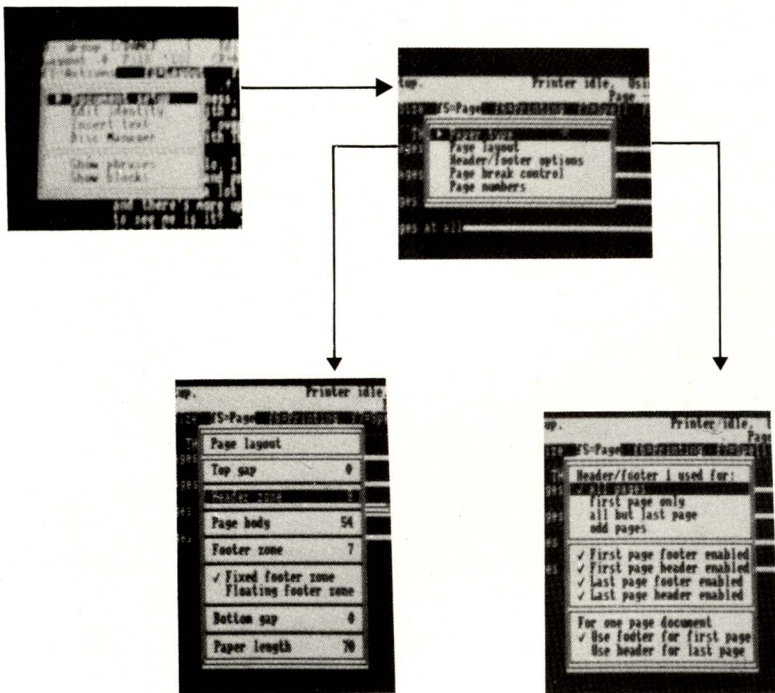

▲ The new menus for laying out pages

# What's on the menu?

LocoScript, as you can hardly have failed to notice, is intended to be a menu-driven word processor. When you are typing text in, there is a list of things you can do printed on the menu line at the top of the screen. For example, you can change the emphasis of the text, show the format codes or change the paragraph layout.

If you want to emphasise a word in bold, you press the key number for 'emphasis' – in this case [F3]. A menu drops down, and you use the cursor keys with  $\leftarrow$  and  $\rightarrow$  to change the print into bold and back. Every operation you can do in LocoScript has a menu, listing out the options facing you.

The advantage of menus is that you don't have to memorise a set of commands to be typed. Instead, you think of the kind of thing you want to

do and the menus that appear prompt you and lead you through the commands needed.

Consequently, the disadvantage of menu-driven programs is that once you get proficient with the system it becomes laborious to go through the menu procedure for every command.

The alternative to menu operation is command key operation. Most other word processors use this – for bold text, you type a key sequence like '[ALT]PB'. This is fast, but can strain the brain cells if you forget the relevant command.

LocoScript gets the best of both worlds. Once you get tired of using menus, you can change to command key operation. To set up bold, '[F3]B', or '[F3]B' to turn it off again.

# LocoScript

# 2

Locomotive Software's faster, more flexible word processor specially developed for the Amstrad PCW8256 and 8512.

## LocoScript 2 gives you:

### Quicker Use

- Faster movement around documents
- Jump direct to a page
- Save and Continue from last position

### Better Results

- Choice of printers – built in/daisywheel/matrix
- New characters – including modern Greek/Cyrillic
- Extra scientific and other symbols
- Accents used with any character

### Easier Operation

- Multiple printed copies
- Disc copying direct from LocoScript
- Completely rewritten handbook – with feature checklist and glossary
- New improved Find and Exchange

### Compatibility

- The familiar feel of LocoScript menus
- Reads existing LocoScript documents

**At just £19.95 can you afford not to have LocoScript 2?**

Locoscript 2 is available by mail order direct from Locomotive Systems Limited. It costs £19.95 including VAT and postage within the UK. Locoscript 2 comes as a complete package including disc with software and examples plus a full user guide. For details and full ordering information, contact

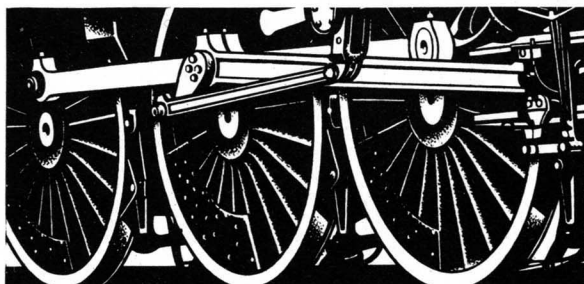

## LOCOMOTIVE SYSTEMS

Allen Court, Dorking  
Surrey, RH4 1YL  
(0306) 887902

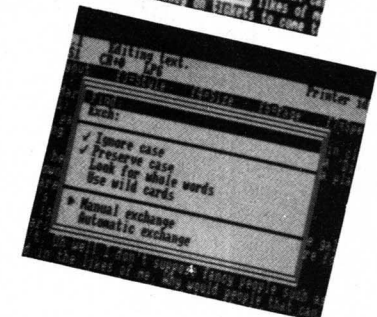
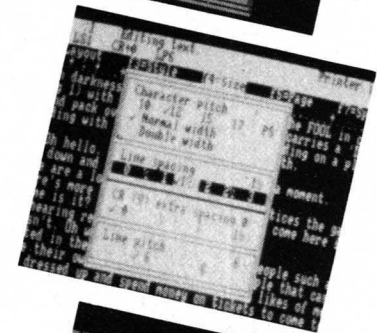
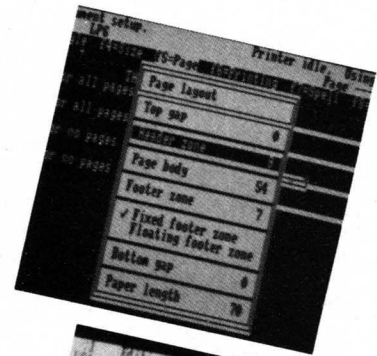

## I into 2 will go

The way that LocoScript 2 stores its files is different to LocoScript 1. You can read documents prepared under LocoScript 1 in LocoScript 2 - in fact they are specially converted the first time you read them in - but you can't use LocoScript 1 to read LocoScript 2 documents.

## Manual Control

Another major new feature in LocoScript 2 is the manual. Whether or not you thought the old manual was good or bad, there has certainly been a lot of comment on it, and the new manual is totally rewritten with around 250 pages. There is a special section for seasoned LocoScript 1 users detailing the changes, so you won't have to plough through it all.

The manual is in a tutorial style covering all aspects of LocoScript, and it replaces the old manual entirely. A reference manual, with full details on the more complex aspects like defining your own characters and writing custom printer drivers, will be available in May as a

All of the well-loved LocoScript styles can be supported, such as boldface, double-strike, superscript and subscript.

You can have wide proportional spacing, 10 pitch wide, 12 pitch wide, 15 pitch wide, 17 pitch wide, proportional spacing, 10 pitch, 12 pitch, 15 pitch, or even 17 pitch, although special pitches really require the use of special wheels.

LocoScript already supports a wide range of special and accented characters (such as: £, \$, €, ç, á, é, í, ó, ú, â, ê, î, ô, û, à, è, ì, ò, ù, ø, ñ, ä, ö, ÿ, ä, ë, ï, ö, ü), but LocoScript 2 will be able to support any accent with any character.

▲ Printout produced from a Juki daisywheel printer using a Courier 10 wheel. Accent characters are produced automatically by overprinting.

## Summing up the changes

Generally, LocoScript 2 has been kept as similar as possible to LocoScript 1 to avoid unnecessary problems for people already used to it. Here is a list of all the changes and new features to be found in LocoScript 2:

- ▶ **Printers:** You can print out to a wide range of printers including daisywheels, via a serial or parallel interface unit.
- ▶ **Character set:** The characters now cover all European languages, including modern Greek, and mathematical symbols. The range of 15 accents can be printed with any of the characters.
- ▶ **Speed:** LocoScript's speed has been vastly improved. In particular you can jump directly to a given page number without scrolling through the intervening text. When you exit from a document, it will not scroll to the end before exiting.
- ▶ **Save & Continue:** now returns you to the same point in the document.
- ▶ **Blocks & Phrases:** The contents of blocks is not lost when you leave a

document. This means you can use blocks to transfer text between files. You can get a list of all 26 phrases in a menu.

- ▶ **Exchange & Match:** You can now search for text regardless of case, and any substitution will have its case adjusted to match the original.
- ▶ **Linked documents:** Different documents can be linked so that their pagination runs continuously when printed out.
- ▶ **Multiple copies:** Can now be printed in one go.
- ▶ **Disc management:** The DISCKIT functions (format, copy and so on) can be done from within LocoScript
- ▶ **New menus:** The menus have been rationalised to make them simpler, especially the header and footer setup operations.
- ▶ **Documentation:** There is a new 250-page tutorial manual.

### PLUSSES

- ☑ 'Jump to page' command makes moving around faster
- ☑ Superb range of characters on the standard printer
- ☑ Can drive daisywheel or other printers
- ☑ You needn't ever use CP/M (or DISCKIT) again
- ☑ Brand new 250-page manual (although the full reference manual is an extra)
- ☑ Costs £19.95

### MINUSES

- ☑ Mailmerger and spell checker are still sold separately
- ☑ Inconvenient for regular CP/M users
- ☑ Still no word counter!!!
- ☑ Comparatively slow at Exchange & Find, and other general scrolling.

RANGE OF FEATURES ■■■■□  
EASE OF USE ■■■■□

PERFORMANCE ■■■■□  
DOCUMENTATION ■■■■□

**8000 PLUS VALUE VERDICT ■■■■□**

separate product.

The text caters for the PCW 8512 much better, with two-drive operations being treated in the body of the manual rather than stuck in an appendix at the back. There are plenty of screen shots showing how things should look at different stages, and a large index.

Inevitably, since it is aimed at taking beginners from unpacking their PCW through to total mastery, you will find that if you are looking for a key fact it may be hidden in large screeds of explanatory text. Locomotive have undoubtedly made the right choice in going for separate tutorial and reference manuals, rather than trying to cover both needs in one.

Total newcomers to word processing have to invest a little effort in reading a manual. Like learning a foreign language, you can't pick it up just by common sense. The new manual is long (on some topics it seems positively laboured), but well enough written and indexed to be genuinely helpful.

0	@	P	Q	p	0	1	2	3	4	5	6	7	8	9	*	+	,	-	.	/	?	O	-	o	0	
!	1	A	Q	a	q	0	1	2	3	4	5	6	7	8	9	*	+	,	-	.	/	?	O	-	o	0
"	2	B	R	b	r	"	%	£	¢	•	1/	1/	1/	1/	1/	1/	1/	1/	1/	1/	1/	1/	1/	1/	1/	1/
#	3	C	S	c	s	#	%	£	¢	•	1/	1/	1/	1/	1/	1/	1/	1/	1/	1/	1/	1/	1/	1/	1/	1/
\$	4	D	T	d	t	\$	%	£	¢	•	1/	1/	1/	1/	1/	1/	1/	1/	1/	1/	1/	1/	1/	1/	1/	1/
%	5	E	U	e	u	%	%	£	¢	•	1/	1/	1/	1/	1/	1/	1/	1/	1/	1/	1/	1/	1/	1/	1/	1/
&	6	F	V	f	v	&	%	£	¢	•	1/	1/	1/	1/	1/	1/	1/	1/	1/	1/	1/	1/	1/	1/	1/	1/
'	7	G	W	g	w	'	%	£	¢	•	1/	1/	1/	1/	1/	1/	1/	1/	1/	1/	1/	1/	1/	1/	1/	1/
<	8	H	X	h	x	<	%	£	¢	•	1/	1/	1/	1/	1/	1/	1/	1/	1/	1/	1/	1/	1/	1/	1/	1/
>	9	I	Y	i	y	>	%	£	¢	•	1/	1/	1/	1/	1/	1/	1/	1/	1/	1/	1/	1/	1/	1/	1/	1/
*	:	J	Z	j	z	*	%	£	¢	•	1/	1/	1/	1/	1/	1/	1/	1/	1/	1/	1/	1/	1/	1/	1/	1/
+	;	K	[	k	[	+	%	£	¢	•	1/	1/	1/	1/	1/	1/	1/	1/	1/	1/	1/	1/	1/	1/	1/	1/
,	<	L	\	l	\	,	%	£	¢	•	1/	1/	1/	1/	1/	1/	1/	1/	1/	1/	1/	1/	1/	1/	1/	1/
-	=	M	]	m	]	-	%	£	¢	•	1/	1/	1/	1/	1/	1/	1/	1/	1/	1/	1/	1/	1/	1/	1/	1/
.	>	N	Ø	n	Ø	.	%	£	¢	•	1/	1/	1/	1/	1/	1/	1/	1/	1/	1/	1/	1/	1/	1/	1/	1/
/	/	? O	-	o	0	/	%	£	¢	•	1/	1/	1/	1/	1/	1/	1/	1/	1/	1/	1/	1/	1/	1/	1/	1/
∞	0	√	⊗	↑	A	Σ	κ	Ж	Ы	М																
1		⊗	↑	B	T	λ	Э	Ь	Н																	
2	L	⊗	↓	Г	Υ	μ	И	Э	П																	
3	J	⊗	←	Δ	Φ	v	К	Ю	Т																	
4	f	⊗	→	E	X	ε	Л	Я	У																	
5	l	⊗	↔	Z	Ψ	π	М	Б	Ф																	
6	j	⊗	↕	H	Ω	ρ	Г	Н	В	Ц																
7	f	⊗	↖	Θ	α	σ	Л	П	Г	Ч																
8	δ	⊗	↗	I	β	τ	г	Т	Г	Ш																
9	∇	⊗	↘	K	γ	υ	М	У	Д	Щ																
∩	∩	⊗	↙	Λ	δ	φ	Б	Ф	ε	ъ																
∪	∪	⊗	↘	М	ε	χ	В	Ц	ж	ы																
∩	∩	⊗	↙	N	ζ	ψ	Г	Ч	э	ь																
∩	∩	⊗	↘	Ξ	η	ω	Г	Ш	и	э																
∩	∩	⊗	↙	Π	θ	ς	Д	Щ	к	ю																
∩	∩	⊗	↘	P	ι	φ	Ε	Ъ	Л	Я																

▲ The LocoScript 2 characters and accent set

## The final word

LocoScript 2 is Locomotive's answer to criticisms it has received over LocoScript 1, and impressive it is too. It is now fast enough for most practical purposes, although still not quite as fast as Protex or WordStar/NewWord.

The character set must be a major selling point. Quite simply, almost no other word processor at any price can produce the sheer range of characters that LocoScript can. For foreign language or mathematical work, do you have any choice? Now that you can get daisywheel print out of LocoScript, there seems hardly any argument not to use it.

All PCW owners who type anything more than straight single page letters will benefit from LocoScript 2. The only people who might not be interested are those who use CP/M a lot and would regularly have to reset the machine to start up the other system.

And at £19.95, what more can you say?

# A PCW without Prottext is like a car with one gear.

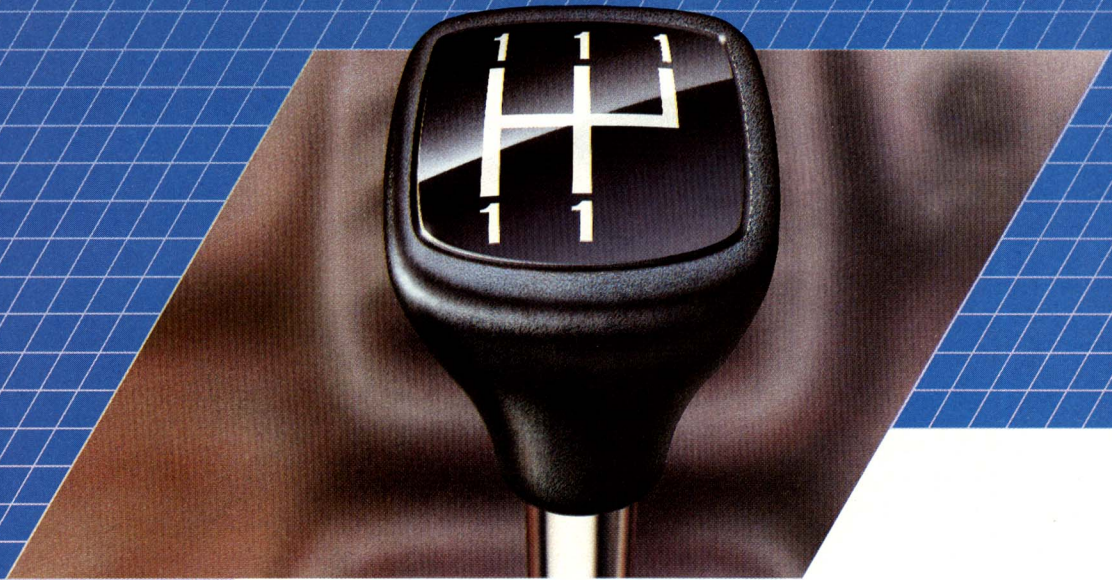

*Cars are useful. You sit down, drive away and — eventually — arrive at your destination. But some people comfortably speed along, while others don't.*

*The PCW is useful, too. You sit down, type away and — hopefully — produce a neat, accurate document. But some people crawl along using inferior software — while others use Prottext.*

*Prottext releases the power of your PCW. It is faster, easier and more flexible than any of its rivals.*

*And because Prottext has been designed exclusively for the PCW, you don't need optional extras.*

*When it comes to text handling, Prottext streaks ahead of the rest. Word search and replace is four or five times faster than rival packages can manage.*

*Naturally, you get full mail-merge facilities to produce top-quality personalised letters — with details read, reformatted and printed from separate files. And Prottext works with any printer.*

*No stopping to check for spelling, either. Prottext's integrated spell-checker scans your text files to produce consistently accurate, professional documents. It comes with an extensive dictionary — to which you can add thousands of your own words.*

*When you've seen how Prottext moves, we know you'll never use anything else.*

*Arnor's Prottext costs an economical £79.95. So if you have the words, we have the way...*

*Call 01-684 8009 — 24 hr service*



***"Accept no substitutes — this is the word processor for the PCW."***

POPULAR COMPUTING WEEKLY

***Releasing your Amstrad's potential...***

***Arnor Limited, 118 Whitehorse Road, Croydon CR0 2JF***

# ARNOR

# WORDS AND PICTURES

**NEWSDESK INTERNATIONAL**  
**£49.95 • THE ELECTRIC STUDIO •**  
**0462 675666**

When PCW's started life they were very serious. Graphics were for effete games-playing machines with pretty coloured screens. Real computers only dealt with letters and numbers. Electric Studio with their light pens, mouse driven art packages and video digitisers, have probably done more than most to bring graphics to the green screen.

So it is only natural that they should be amongst the first to hit the market with a desk-top publishing package. Newsdesk International has obviously evolved directly from their successful art packages and makes full use of the advances that have been made in producing illustrations on the PCW.

The idea is that you can produce a page just like a page of your favourite tabloid. You can create a masthead and illustrations in the art package, write headlines in 18 or 36 point in different type faces and arrange your text in a variety of type faces around pictures taken from digitised pictures or culled from Electric Studio's Snip Art package.

Having said this, it is obvious that the emphasis is still on the art side. It includes the company's complete art program, which seems to accentuate this fact. It soon becomes obvious that it is easier to make the page look good than to carry out the basic tasks of getting the words onto it.

Those used to the Electric Studio system of menus will soon be zipping back and forward through the various options, though it can be daunting to the uninitiated, especially as the path through the menus sometimes seems to lack logic.

It is also true that the complexity of the system is such that a quarter of the screen seems to be covered by menus – a problem at times. For instance when you load the Index file from Snip Art to see the choice of possible illustrations, you find that a couple are always covered by the menu.

The program has aimed to give great flexibility in the layout of text, but the price to be paid for this is that beginners (and even a few experts) may be confused by the very blankness of the empty page.

### All together now

The main danger in sitting down in front of a desktop publishing program is the desire to use everything at once. By the time you've mixed seven different type faces (with your headline in 36 point Old face, of course), reversed out boxes and used fifteen pieces of Snip Art, the final result can be less than a work of art. Producing a really professional-looking piece of work is probably more to do with restraining the natural desire to use everything on a single page.

You have the choice of three type faces in 12 point for your body copy (the main blocks of text). While not perhaps the sort of font a professional magazine would use, they all quite readable and can, within reason, be mixed on the same page.

There are five fonts in 18 point for smaller headlines and seven fonts in 36 point for your main headlines. There is a reasonable mixture of practical and artistic fonts with most of the 'exciting' type faces sensibly restricted to 36 point.

You also have the choice of using these faces in single or double width to make best use of the space available and it is a simple, if time-consuming, job to delete your first attempt and change the font.

You enter headlines using the 'Keyboard Input' option which allows you to place your text anywhere on the page. The program helps you by forcing you to choose a position that is suitable to the size of type face you are using, so that you can't overwrite the line above. It does work against you, however, when you try to mix type faces or want to place something precisely in a box.

One disappointing feature is that there seems no simple way of discovering which font and size is currently selected. Given that you will often need to change fonts, you may prefer to go through the relatively long process of checking through the 'Font Change' menu each time rather than risk trying to write your body copy in 36 point Old face.

### "I take my text..."

There is a text handling Mini Editor with which you can edit ASCII files or even create your documents. This works well enough although most people will probably want to write their documents in the homely



# THE WORLD OF DESKTOP PUBLISHING ON YOUR AMSTRAD PCW



**Fleet Street Editor Plus brings desktop publishing to your Amstrad PCW 8256/8512. Now you, too, have a professional, low-cost alternative to expensive and time-consuming typesetting and artwork services.**

## Use Fleet Street Editor Plus to create

- Multi-column newsletters and publications
- Advertising layouts and brochures
- Business reports and contracts
- Promotional literature and specification sheets
- Flyers
- Organisation charts and flow charts
- Invitations and announcements
- Menus, cards, letterheads and much more

Fleet Street Editor Plus is flexible, yet very easy to use. Using a what-you-see-is-what-you-get principle, page layout and design becomes second nature.

## Page make-up

- Full page composition with multiple columns
- Left and right hand page orientation and automatic page numbering for multiple page documents
- Text editing and picture sizing/cropping in page make-up
- Linked text blocks
- Variable page sizes and column widths
- User-created and editable page dummies

## Text handling

- Type directly into the text editor or read in from an ASCII word processed file
- Automatic word wrap
- Justification or proportional spacing
- Variable line leading
- Five different fonts in varying sizes and styles

## Graphics

- Full feature studio package for graphic creation and manipulation
- Accepts lightpen input
- A library of ready-to-use graphic images
- Facility to import graphics screens from other software packages

## Output

- Dot matrix

## Handling Features

- Pull-down menus
- Optional mouse control
- File management structures
- Hot-line support for registered users

## System Requirements

- Amstrad PCW 8256 or 8512
- PCW or Epson-compatible printer with Centronics interface

## Optional

- Kempston mouse
- Electric Studio lightpen

**OUT NOW**

**PRICE: £69.95**

**MIRRORSOFT**

If you would like to receive more information on Fleet Street Editor Plus for PCW write to Dept. FSE, Mirrorsoft Ltd, Freepost (BS4382), Paulton, Bristol BS18 5BR  
Telephone enquiries: 01-377 4645

# ONTEST

## Jargon Buster

**Masthead** – The logo at the top of your newspaper that tells you whether you are reading the Sun or the Telegraph. There are other clues.

**Digitiser** – An ingenious piece of equipment that can produce a picture in the computer taken from a single frame from a video camera or recorder.

**Dwyle Flonking** – We are assured this is an ancient Dorset game although we frankly just don't believe the rules that we have heard.

environment of their word-processors and only make their last minute changes in the editor.

You position the text on the page via the 'Windows' menu. This is where you discover that owning a Light Pen or Mouse is a good investment. It is not a quick exercise at the best of times but using the keys can be painfully slow.

You can vary the size of a column to your heart's content, giving real flexibility to page make-up. Once you have filled a column, you move the cursor to another part of the page or duplicate the column you've just completed. The theory is that you can keep all your column sizes the same width across the page.

You can keep track of your position on the screen by a read out showing the cursor position as a percentage of the x and y axes. It takes a bit of practice to feel totally at ease with this feature.

As you are putting the page together 'a bit at a time', it's difficult to plan ahead. While you are able to produce regularly sized columns for most of your page, it is a major achievement to do this right across its width. Luckily you can make your final column any size to use up the space.

### Start where you stop

When you have filled one window of text the program automatically takes a note of where you stopped in the text and will start there (or anywhere else that you specify) when you come to fill the next window.

# STEP ASIDE RUPERT MURDOCH

Can you remember when you saw your first LocoScript document being printed out? Can you remember how impressed you were? It was a thing of beauty.

If, after months of producing flawless, beautifully printed documents you are so biased that you no longer boggle at your address printed in 10 pitch double space, then perhaps a desktop publishing package is the answer for you.

Now you can mix different fonts and

type sizes on the same page, use all sorts of fancy headlines and even fit in illustrations. If you're keen enough you can even turn out your own daily newspaper and rock the Fleet Street moguls. Well maybe you'd better start with the bi-yearly newsletter for the local chapter of the National Association of Dwyle Flonkers and work your way up.

A number of these desktop packages are due to appear on the market in the next few weeks.

Unfortunately there is no way to accurately calculate the length of an article on the page or how much of it you have used, so it would require a very complex trial and error process to, say, produce an article split evenly over four columns.

The A4 page is obviously too large to show on screen, but you can choose which part of the page you want to see any time by a rather lengthy process called setting the screen. You can also see a reduced version of the complete page to check the overall design and see what space you still have to fill. You position your text in a box on this small page and are then asked whether to clear the text already in that area (particularly handy if, heaven

forbid, you should make a mistake and want to start again.)

It is not easy to position these boxes accurately, especially as it seems impossible to start text right at the top of the window.

You can have an open or closed box drawn round your text or draw lines on yourself using the art package. In fact the range of features you can use to brighten up your text is endless. For example a simple filled rectangle written over with reverse ink text makes an effective reverse block heading.



### A picture or a thousand words

Where Newsdesk wins is in the way that you can use pictures. The simplest way to do this is to invest in an Electric Studio Snip Art disc with its wide variety of cartoon images to suit any situation. These can be customised using the art package or you can even create your own illustrations from scratch. The classiest way, of course, is to invest in a digitiser and snatch whatever image you want from video tape.

You can then take these pictures and squeeze them into the space available, even distorting them to fit should the need arise. When you are content you can then opt to save the page to disc or print it out.

One problem with desk-top publishing programs is the quality of the print. Hard copy is invariably produced using a built in screen dump facility. This is both time consuming and often produces a less than stunning result.

Taking this into account Newsdesk International produces surprisingly good results which can be improved further by taking a photo-copy. However it would perhaps be advisable to postpone launching your competitor to 8000 PLUS until you can afford a laser printer.

### Verdict

Those who already use Electric Light Studio products may well find this a natural upgrade. If you are the sort of person who wants to have complete control over page lay-out and produce a real work of art, this is a serious proposition. It's not recommended for people in a hurry, though.

#### PLUSES

- ☐ Complete control over all elements in the page.
- ☐ Can take digitised pictures.
- ☐ Good quality print.

#### MINUSES

- ☐ Text handling slow and cumbersome.
- ☐ Menus can be confusing.
- ☐ Not easy to undo mistakes.

RANGE OF FEATURES ■■■■□  
EASE OF USE ■■□□□

PERFORMANCE ■■■□□  
DOCUMENTATION ■■■□□

8000 PLUS VALUE VERDICT ■■■□□

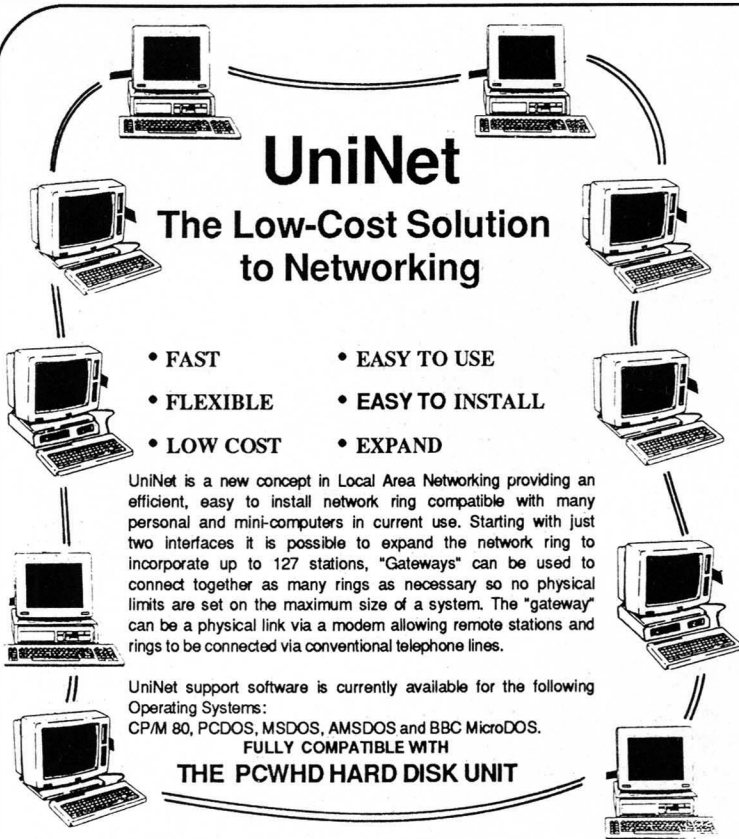

## UniNet

### The Low-Cost Solution to Networking

- FAST
- EASY TO USE
- FLEXIBLE
- EASY TO INSTALL
- LOW COST
- EXPAND

UniNet is a new concept in Local Area Networking providing an efficient, easy to install network ring compatible with many personal and mini-computers in current use. Starting with just two interfaces it is possible to expand the network ring to incorporate up to 127 stations, "Gateways" can be used to connect together as many rings as necessary so no physical limits are set on the maximum size of a system. The "gateway" can be a physical link via a modem allowing remote stations and rings to be connected via conventional telephone lines.

UniNet support software is currently available for the following Operating Systems:  
CP/M 80, PCDOS, MSDOS, AMSDOS and BBC MicroDOS.

**FULLY COMPATIBLE WITH  
THE PCWHD HARD DISK UNIT**



# THE PCWHD HARD DISK UNIT



TRANSFORMS YOUR  
AMSTRAD PCW COMPUTER  
Into a powerful Business System without  
taking up additional desk space.

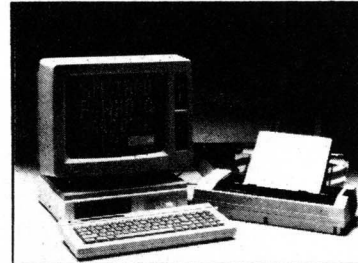

- |  |  |
|--|--|
| <ul style="list-style-type: none"> <li><input type="checkbox"/> 10 or 20 Megabytes Formatted Capacity</li> <li><input type="checkbox"/> Fully supported by Locomotive software</li> <li><input type="checkbox"/> Supplied with Enhanced CP/M Plus and LocoScript in which the Hard Disk Drivers are an integral part. Most European versions available.</li> <li><input type="checkbox"/> Very fast Access time - 85ms</li> <li><input type="checkbox"/> Transforms the Amstrad PCW8256 Word Processor to a Powerful Office Business System. Compatible with all good CP/M3 software.</li> </ul> | <ul style="list-style-type: none"> <li><input type="checkbox"/> Easily Installed Without Specialist Tools or knowledge.</li> <li><input type="checkbox"/> The Amstrad Expansion Socket is extended and remains available for use</li> <li><input type="checkbox"/> The Whole Upgrade system can be fed by a Single Power Cord</li> <li><input type="checkbox"/> Hard Disk Utilities Provided for Ease of Operation</li> <li><input type="checkbox"/> Newstar "Shell" and "Newspool" supplied.</li> <li><input type="checkbox"/> Supports LocoMail &amp; LocoSpell</li> <li><input type="checkbox"/> Network available</li> </ul> |
|--|--|

10 Megabyte Hard Disk Kit  
20 Megabyte Hard Disk Kit  
40 Megabyte Hard Disk Kit

£449.00 + VAT r.r.p. (U.K.)  
£599.00 + VAT r.r.p. (U.K.)  
£871.00 + VAT r.r.p. (U.K.)

**ASD PERIPHERALS**

Contact Ray Barber, Aston Science Park, Love Lane, Birmingham B7 4BJ. Tel: 021-359 0981 Telex: 33 4535, Fax: 021-359 0433

## Oberon International OMNI-READER

# £59.99

*Including VAT, Postage and packing*

The **Omni-Reader** is a new and easier alternative to typing in data. By using advanced character recognition techniques the **Omni-Reader** can read printed text and send it to the computer as though the information was coming from a modem.

The vast majority of office correspondence can be read by the **Omni-Reader** which supports the four major typetypes used. These are *Courier 10*, *Courier 12*, *Letter Gothic* and *Prestige Elite*. To enter a page of text you place it under the special **Omni-Reader** ruler and read the text with an electronic eye. A small computer within the **Omni-Reader** then translated those images into standard ASCII text.

Any computer with a standard RS232 port can make use of the Oberon **Omni-Reader**, all you need is some communications software and the cable for your computer.

*Liquidated  
Stock*

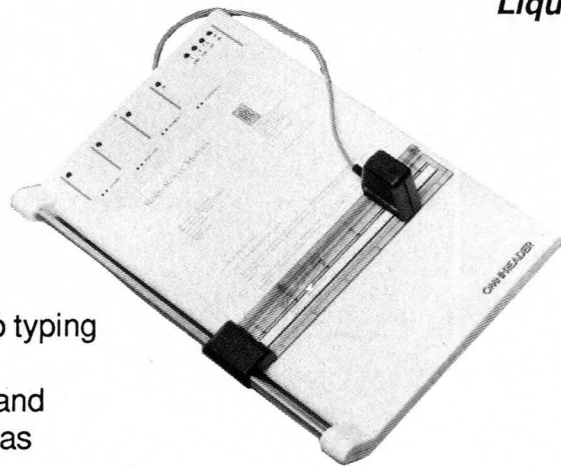

To: **Omni-Reader Sales, Metroheath Ltd,** Tel. 247 7184  
287-289 Whitechapel Rd, London E1. VAT no. 397296294

- .....Omni-Reader(s) at £59.99 each
- .....Amstrad CPC Interface & Software packs £25.00
- .....Amstrad PCW £14.95
- .....Amstrad PC Cable & Software £20.00
- .....IBM Interface & Software packs £20.00
- .....Atari ST Cable and Software £19.99
- .....BBC Cables at £11.75 each
- .....Spectrum 128/Spectrum +2 cables at £11.75

Name \_\_\_\_\_  
Address \_\_\_\_\_

Paid in full Incl. VAT: £.....

*Make cheques and postal orders to: Metroheath Ltd.  
Please allow 28 days for delivery.*

**ANNOUNCING**

# The Joystick Pack FOR AMSTRAD PCW

**£29.95**



Available From:- **WHSMITH** **John Menzies** **ALLDERS** DEPARTMENT STORES LTD OR DIRECT MAIL ORDER...

**PACK CONSISTS OF:-**

**Quickshot 2 Joystick**

Helicopter Style Grip ★ World's Best Selling Joystick  
★ Perfectly Fitting Trigger Fire Button ★ Sleek Top  
Fire Button ★ Four Suction Cups for Extra Stability.

**Ram PCW Joystick Interface**

Superb Flush Fitting Design ★ Incorporates standard  
9-Pin Joystick Port ★ Securing Points for Fail-Safe  
Connection ★ Connects Via Amstrad PCW Expansion Port.

**Spectacular Tomahawk Flight Simulator**

Real-Time Flight Simulator ★ Based on US Army Apache  
Advanced Attack Helicopter ★ Allows Flight Training  
before going into battle against enemy ★ Full Set of Flying  
Instructions Included.

POST TO : SPECTRAVIDEO LTD. 165 GARTH ROAD, MORDEN SURREY SM4 4LH.

PLEASE SUPPLY ME  
QTY.

UNIT PRICE TOTAL

QTY.	UNIT PRICE	TOTAL
AMSTRAD PCW JOYSTICK PACK	£29.95	
POSTAGE AND PACKING		£1.05
TOTAL		£

I enclose cheque/postal order no. .... payable to SPECTRAVIDEO LTD for the above total.

Please debit my VISA/ACCESS account number

Signature \_\_\_\_\_ Expiry Date \_\_\_\_\_

Name \_\_\_\_\_ Tel. No. \_\_\_\_\_

Address \_\_\_\_\_

Post Code. \_\_\_\_\_

SPECTRAVIDEO LTD. REG.No.1745592 ENGLAND (Please allow 28 days for delivery.)

**SPECTRAVIDEO LTD.**  
(A WHOLLY OWNED SUBSIDIARY OF ASH & NEWMAN LIMITED)

**SPECTRAVIDEO™**

165 Garth Road, Morden, Surrey SM4 4LH, England. Telephone: 01-330 0101 (10 lines) Telex: 28704 MMH VANG Facsimile: 01-337 5532

# SAVE NOVENIA

Rainbird Software and 8000 Plus give you the chance to test your skills at zapping thousands of interesting aliens...FREE! Win one of 10 copies of *Starglider* in our simple but devious competition.



This month Rainbird Software have launched their new space game *Starglider* on the PCW – a traditional shoot 'em up with a real touch of class. And here is your chance to gain a commission in the Novenian air-force by winning a copy of the game in our simple competition.

Following their successful series of adventure games Rainbird have applied their talents to a graphic arcade game. But in line with the high intellectual standard of PCW users, they have produced a product that still taxes the grey cells.

In *Starglider* you are trying to save the planet Novenia from the attacks of the evil Egrons. By the miracle of vector graphics, your green screen is transformed into the cockpit of an Airborne Ground Attack Vehicle, no less, where you can see the baddies dance temptingly before your lasers and super missiles.

The Rainbird package also includes a novella and playguide to let you really eat, sleep and drink your role. Prepare to be obsessed.

## TOO CLEVER BY HALF, CURSE YOU!

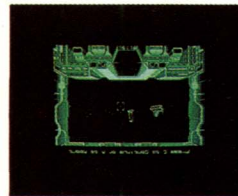

To win one of the 10 games on offer you need to be able to use words - no problem to a PCW user. But to make it more difficult we are going to put one or two little restrictions on the words you use.

Do you remember those boring old quizzes where you had to put together as many words as possible using only the letters of the word Heliotrope?

Well in this month's competition we are interested to see how many words you can extract from *STARGLIDER*. But then (to make it more interesting for us than reading 2000 lists of four letter words) we want you to write a sentence using only these words. For instance you could write 'STARGLIDER IS A REAL GAS'. It won't win, but you could write it.

Points will be given for originality, humour and logic. Why not aim to encapsulate the meaning of life in a humorous way? Shouldn't be that difficult, and to spur you on there are 40 runners-up prizes of elegant and valuable *Starglider* balsa wood throwing gliders.

Write your gems on postcards or the backs of envelopes (*This is important - Ed*) and send them to *Starglider Competition, 8000 Plus, The Old Barn, Somerton, Somerset TA11 7PY*

### RULES

- 1 Entries must arrive no later than the 22nd of May 1987 and the winners will be announced in the July issue of 8000 Plus.
- 2 The judges decision is final and no correspondence will be entered into.
- 3 There is no rule 3.

# TRAINS, PLANES AND ZAP 'EM UPS

Right on cue, Tony Flanagan takes the controls of a variety of craft this month.

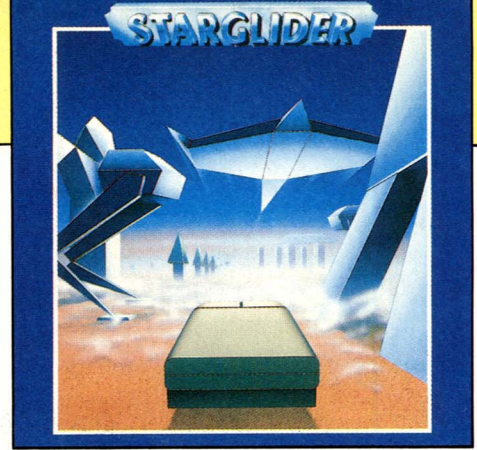

## STARGLIDER £24.95 • Rainbird • 01 240 8838

Isn't it peculiar how planets are always being invaded by psychopathic aliens? Personally, I've never seen an alien, though I have had to look closely at my next door neighbour's children once or twice. In *StarGLider*, the planet Novenia has been invaded by the Egrons who, as well as having the worst name in science fiction history, are bent on destruction. Well, who isn't these days?

As usual it's your task to sort these psychos out. Consequently, in this vector graphic flight simulation, you assume the role of pilot of an Airborne Ground Attack Vehicle (AGAV). This means that you can battle with

both airborne and ground-based enemy craft.

These take a number of forms. Some look like birds of prey, others like the Skywalkers in the Star Wars films, but there are at least another fifteen to contend with. All are well animated vector graphics of the type you might have seen in the *Battle Zone* tank game in the arcades. Most awesome of all, however, is *StarGLider One* which must be located and destroyed as you fly over Novenia's barren landscape.

Not surprisingly, the AGAV is supplied with three types of weapon: laser, missile and super-missile. The last of these is the most powerful but is only available when specific missions have been completed. Laser sights can be fixed or movable.

The AGAV can be rearmed by docking with rotating silos. This procedure is very tricky to say the least and requires excellent judgement and timing. Fortunately, the AGAV is very manoeuvrable. Once inside, the silo's computer will provide extra information on enemy craft.

The instrument panel includes altimeter, radar scanner, energy level, shield status, velocity indicator and so on. The top of the screen details the AGAV's direction and your score, depending on how many of the enemy you have destroyed.

As with other Rainbird packages, this one includes a novella and a comprehensive playguide, and there is also a keyboard chart. The novella is not just cosmetic - it includes information about the range of enemy craft you have to contend with and gives precise details on how to dock with silos.

As a shoot 'em up (with a hint of strategy) this game is the best around. Excellent!

- PLUSES**
- ☑ Lots of atmosphere
  - ☑ Fast action
  - ☑ Superb 3D graphics
  - ☑ Excellent animation
  - ☑ Joystick and Mouse options

- MINUSES**
- ☐ Playguide unnecessarily complex

**GRAPHICS  
ADDICTIVENESS**



**LASTING APPEAL  
VALUE VERDICT**

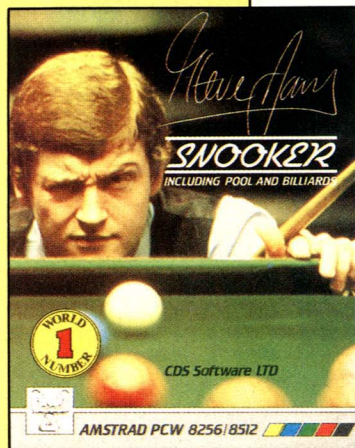

## STEVE DAVIS SNOOKER £14.95 • CDS • 0302 21134

I'm more of an Alex Higgins myself. There's something too clinically perfect about Steve Davis which always infuriates me. Didn't he once say that snooker was more important than sex? Perhaps he's got a point...

The game includes Snooker, Pool and Billiards, and all three can be played either alone or with an opponent. They're all accompanied by simple but comprehensive playing instructions, covering the rules of each game and the controls.

In each of the three games, the table, balls and additional features are all neatly presented. The position of the cue ball and strikes are

cross, which is moved by using the cursor keys or, if you prefer, by joystick.

At the bottom of the screen a bar indicates the power of each shot, which can be varied by pressing the appropriate key. There is also the option of putting a spin on the cue ball a magnified version of which is shown at bottom right of the screen. Again, by moving a little black cross you can choose exactly where you want the cue-tip to hit the cue ball. This enables you to screw back, up or indeed in any direction you like.

The screen also details the number of visits each player has made to the table, the colour of the ball he is attempting to hit and the break. At the top of the screen is a scoreboard which also indicates any foul shots.

The game's playability is in no way marred by the lack of colour. In the snooker game the reds are clearly distinguishable from the colours (which are numbered in accordance with their value). In pool, 'stripes' and 'spots' are clearly different; in billiards, different shades distinguish the three balls on the table.

As a pool player myself, I found the play realistic, demanding the same precise judgement required in the real game. The movement of the balls is as authentic as one can realistically expect - indeed, they're the roundest balls I've seen in a computer game of this kind.

If you fancy yourself as a snooker ace but haven't room in your garret for a full-size table, then Steve Davis Snooker should prove good value for money.

- PLUSES**
- ☑ Very playable
  - ☑ Easy to get into
  - ☑ Almost as demanding as the real thing
  - ☑ Good screen layout
  - ☑ Three games in one

- MINUSES**
- ☐ Lousy title
  - ☐ Where's the chalk?

**GRAPHICS  
ADDICTIVENESS**



**LASTING APPEAL  
VALUE VERDICT**



**GUARDIAN AND BLAGGER**  
£14.95 • Alligata • 0742 755796

This two-game package from Alligata presents the lighter and less demanding side of PCW gaming. In both, reflex action is more important than brain-power.

Blogger is a platform game in which you take on the role of Rodger the Dodger. As the name would suggest, Roger just can't keep his hands to himself, at least where money's concerned. In this game, he finds himself in the wealthy town of Umstrid (I know it well), a master-burglar's dream.

Of course, every house, shop and bank in Umstrid has its own safe where the nouveau riche et al have stashed their lovely loot. Roger can't resist!

The aim of the game is to open each of the twenty safes, one per screen. To do this you must gather up the keys. This is a tricky business to say the least. Moving platforms, disappearing staircases, and trip wires have to be negotiated. And there are also more human obstacles to contend with in the form of householders, nightwatchmen and security guards.

To make things even more difficult, time is strictly limited. A bar, stretching across the bottom of the screen, indicates how much is left. Any mistake can set off the alarm which is simulated by a series of high-pitched bleeps and a flashing screen. Every time it goes off poor old Roger loses one of his five lives.

The graphics in this game are simple but effective. The keys are very responsive, which is just as they should be in a game where speed and timing are essential. (There is a joystick option if you prefer.)

Guardian is a fast action shoot em' up. As a fighter pilot, it's your job to defend the planet below from swarms of less than friendly aliens. Their intent is to capture the waving humanoids scattered across the planet's bleak landscape.

Points are awarded for destroying enemy ships. These come in a variety of forms - landers, mutants, pods, swarms and baiters - and have different functions. Part of your job is to pick up humanoids from the planet surface as well as rescuing them from the landers which attempt to carry them off.

Guardian is less demanding and therefore a less interesting game than Blogger. The play is monotonous and the stark screen doesn't help. Both games provide a pleasant diversion from more taxing stuff but with games like Starglider around I know which I'd spend my money on.

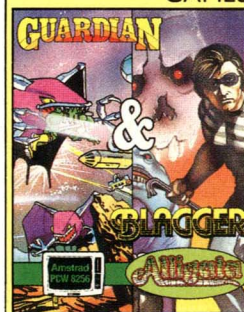

**PLUSES**

- ☐ Responsive keys
- ☐ Readily playable
- ☐ Simple objectives

**MINUSES**

- ☐ Repetitive
- ☐ Graphics are too abstract

**GRAPHICS** ■■■□□  
**ADDICTIVENESS** ■■■□□

**LASTING APPEAL** ■■■□□  
**VALUE VERDICT** ■■■□□

**HEATHROW AIR TRAFFIC CONTROL/SOUTHERN BELLE**  
£16.95 • Hewson • 56b Milton Trading Estate, Milton, Abingdon, Oxon OX14 4RX

If you're the kind of person that likes to be in control, then these two excellent simulations might be just what you've been looking for.

In the first you find yourself in the control tower at Heathrow Airport with sole responsibility for landing all incoming aircraft - no mean task by any standards! Not only do you have to handle a variety of data, but your decisions have to be of the highest order. Make a mistake and its Airport II all over again.

The screen is excellently presented, managing to convey all the information necessary for the job both clearly and concisely. In the centre is the radar screen which displays Heathrow Airport and the landing runway. Surrounding that are four stacks which are circled by aircraft waiting to land. Aeroplanes are identified as white blocks with a trail of dots.

The communication link with aircraft is displayed at the bottom of the screen where altitude, direction and speed instructions can be given.

There are eight levels which get successively more difficult and present the player with different problems: from coping with mixed traffic to emergency landings.

Southern Belle takes you back to the 1930s and puts you in control of a King Arthur class steam locomotive. Your task as fireman and driver is to take the London to Brighton run, 50+ miles in all.

The centre of the screen displays a view of the cab and controls, and the line ahead. Graphically, this is nicely done, though the landscape you pass through is depressingly barren. The rest of the screen provides control information: speed, distance, signal, gradient, coal and water.

There are seven levels in all, from a slow training run to faster ones where the problems you encounter are harder to deal with.

Games of this kind will no doubt appeal to aviation and steam locomotive enthusiasts, and their potential in the classroom cannot be ignored either. But their appeal beyond that is questionable. Personally, I found them a little too dry.

EXIT

▼ The Southern Belle at the beginning of her journey. I wonder if customer service was any better in the 1930s.

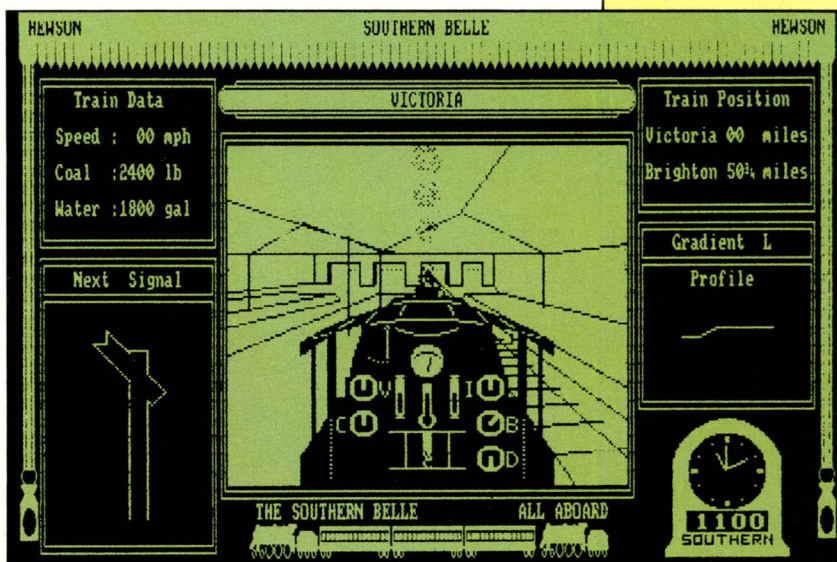

**PLUSES**

- ☐ Relatively simple and concise presentation of complex information
- ☐ Cerebrally, very testing
- ☐ Comprehensive instruction manual
- ☐ Good HELP facility

**MINUSES:**

- ☐ Takes along time to get into
- ☐ Not the most exciting of games

**GRAPHICS** ■■■□□  
**ADDICTIVENESS** ■■■□□

**LASTING APPEAL** ■■■□□  
**VALUE VERDICT** ■■■□□

# MASTERFILE 8000

FOR ALL AMSTRAD PCW COMPUTERS

MASTERFILE 8000, the subject of so many enquiries, is now available.

MASTERFILE 8000 is a totally new database product. While drawing on the best features of the CPC versions, it has been designed specifically for the PCW range. The resulting combination of control and power is a delight to use.

Other products offer a choice between fast but limited-capacity RAM files, and large-capacity but cumbersome fixed-length, direct-access disc files. MASTERFILE 8000 and the PCW RAM disc combine to offer high capacity with fast access to variable-length data. File capacity is limited only by the size of your RAM disc.

A MASTERFILE hallmark is the provision of multiple, user-designed display formats. This flexibility remains, but now it's even easier. With MASTERFILE 8000 you design your formats "live"; no more questionnaires, just move your format effects around the screen using the cursor keys!

Record updating is even easier than before — just steer your cursor to any field on the screen and then insert/erase/alter as required.

Special options are provided for handling dates and surnames, and column totals can be generated.

All screen work is done graphically — and hence we offer unique panel, box, and ruled line options. Choose the line spacing at pixel resolution — you will be amazed how much clearer 9-pixel lines are than the usual 8-pixels. (Study the picture.) And all this faster than CP/M normally lets you paint the screen! PCW printer functions, under menu control, are provided.

Any file can make RELATIONAL references to up to EIGHT read-only keyed files, the linkage being effected purely by the use of matching file and data names.

You can import/merge ASCII files (e.g. from MASTERFILE III), or export any data (e.g. to a word-processor), and merge files. For keyed files this is a true merge, not just an append operation. By virtue of export and re-import you can make a copy of a file in another key sequence. New data fields can be added at any time.

File searches combine flexibility with speed. (MASTERFILE 8000 usually waits for you, not the other way around.) You can even assign subsets of a file into one or more of seven pigeon-holes for subsequent reference or further manipulation.

Megaglomerate Ltd				
Sales Contact: Martin McManic		Mega House 143-145 London Road Chelmsford Essex CM12 5DC		
Telephone: 0245 654321				
Reference: MGL				
Date of last order: 14 Aug 86				
Value to date: £31,455.00				
Ref	Maker	Model	Specification	Price ex VAT
C5001	Epson	FX105	100cps AMGLA 90col	£310
C5002	Epson	FX105	100cps AMGLA 132col	£410
C5003	Epson	FX105	100cps 132col	£195
C5004	Epson	LX100	100cps 220LA 90col	£435
C5005	Epson	LX100	100cps 220LA 90col	£575
C5006	Epson	LX100	100cps 220LA 132col	£275
C5007	Epson	LX100	300cps 220LA 90col	£295
C5008	Epson	LX100	100cps 220LA 90col	£225
C5009	Epson	LX100	100cps 220LA 132col	£370
C5010	Canon	AS5	100cps 450LA 90col Colour	£440
C5011	Canon	AS5	100cps 450LA 90col	£390
C5012	Canon	SS10	100cps 450LA 90col	£410
C5013	Juki	SS20	15cps daisywheel	£280
C5014	Juki	6100	30cps daisywheel	£350
C5015	Juki	6200	35cps daisywheel	£1,795
C5016	Juki	6300	200cps 220LA 90col	£2,700
C5017	Fujitsu	DX	200cps 220LA 132col	£1,700
C5018	Fujitsu	DX	8 page min M	£2,690
C5019	Fujitsu	LBP5A1	8 page min M graphics	£2,690
C5020	Canon	LBP5A2	8 page min M	£2,690
C5021	HP	Laser+	8 page min M graphics	£2,690
C5022	Taxan	KP-810	100cps 220LA 90col	£285

Customer Details and Invoices				
British United Freight 493 Western Avenue Gloucester GL9 5JN		Tel: 0452 654321	Contact: Mike McManic	Ref: BUF
Invoice	Tax point	Amount	Date paid	Comments
12004	20 Aug 87	£235.00	02 Oct 87	
12399	29 Aug 87	£98.00	02 Oct 87	
12450	01 Oct 87	£305.00		
12453	21 Oct 87	£133.00		
12533	03 Nov 87	£1,004.50		
12598	10 Nov 87	£355.65		
12743	11 Nov 87	£200.00		
12782	11 Nov 87	£39.20		
12839	04 Dec 87	£883.55	04 Dec 87	Cash with order
Totals:		£3,253.90		
Date of invoice				
Drive:A File:INVOICES Records:00017 Selected:00009 Key: Format:1				

Keyed files are maintained automatically in key sequence, with never any need to sort. You can have unkeyed files too, where records can be inserted at any point in the file.

FIELD-TO-FIELD CALCULATION is available, using any mixture of terms and arithmetic operators + - \* / ( ).

MASTERFILE 8000 is totally menu-driven, fully machine-coded, and comes with example files and a detailed manual. We claim (modestly) that you will not find another filing system with such power, flexibility, and friendliness.

MASTERFILE 8000 costs £49.95 including VAT and P&P to anywhere in Europe. Elsewhere please add 20% for air-mail service. ACCESS/VISA/MASTERCARD orders are welcome, written or telephoned, quoting card expiry date. Make cheques payable to "Campbell Systems".

Our normal response is return of post, 1st class. CAMPBELL SYSTEMS (Dept 8PL) 7 Station Road, EPPING, Essex CM16 4HA, England. Tel: (0378) 77762/3

# DIY DATABASE

Chris Lilley discovers how to build his own database using the PCW's standard HELP command

**The HELP program on Side 4 of the Amstrad master discs works like an electronic manual about CP/M. With a little cunning you can actually make up your own text storage database about anything you want, from recipes to part catalogues and instruction books. Watch out for the country's database salesman piling up at the foot of Beachy Head.**

Options only work for the current Help request. You must specify the option [NOPAGE] on every Help command you give, if you want it, since it reverts to the default after each.

## Rolling your own

Although the main part of CP/M is standardised, manufacturers are free to add on their own extras to it. For example Amstrad added DISCKIT and SETKEYS. To allow the HELP file to be updated to include these new commands, there are a further two little-known options – EXTRACT and CREATE.

The HELP utility is a program on side 4 of the system discs which provides helpful information (hence the name) about how to use the CP/M commands and other programs supplied with the machine. You can use it from the CP/M A> prompt in two ways: make sure you have your copy of side 4 of the master discs in the current disc drive and type

A>HELP  
or A>HELP topic

The first one gives a list of the topics available, and the second gives details on a specific topic once you know what you are looking for. In practice, the information you get out of HELP as it is supplied is rather terse, and you will probably find it more confusing than the manual unless you understand the jargon.

Having read about a particular topic, there are several things you can do. Typing a full stop will redisplay what you have just read; typing a question mark produces a list of what's available. The program may list some subtopics which go into more detail. To read about one of these, type a full stop followed by the name of the subtopic. It is even possible to specify the subtopic directly from the A> prompt, for example HELP PIP OPTIONS where 'PIP' is the topic and 'OPTIONS' is the subtopic.

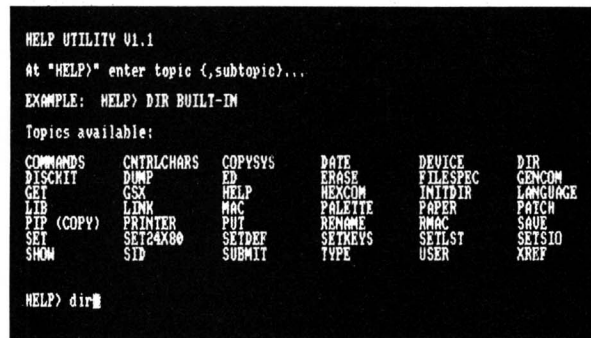

▲ The standard HELP topics using Amstrad's supplied data

Try out an example: load up CP/M, type HELP and then DIR as the topic. Once the program has displayed the relevant information, it gives two subtopics for your perusal – BUILT-IN and WITHOPTIONS – and then gives a HELP> prompt. This means much the same thing as the A> prompt in CP/M, ie. 'type something here', but reminds you that you are still in the HELP program.

Now type .W to select the second subtopic (the program only requires as many letters as are needed to distinguish between the possible options). See how this subtopic is divided still further into OPTIONS or EXAMPLES, and that the 'path' taken to reach this point is given at the top left of the screen. Typing either .O or .E would take you further along this path, whereas typing a topic without a full stop starts you off from the beginning again. Pressing [RETURN] without typing anything finishes a help session and returns you to CP/M.

## Optional advice

An 'Option' is an instruction to the program to do something differently. Options are selected by enclosing them in square brackets, []. For example:

A>HELP FILENAMES [NOPAGE]

There are two options that can be given when looking something up in the help file – NOPAGE or LIST. Only one may be used at a time, and the topic must also be given.

The NOPAGE option makes the program display a whole topic at once, rather than displaying a screenful of information and then prompting you to press [RETURN]. The LIST option is the one to use if you want a printed copy. It stops the "Press RETURN" message and also cuts out gratuitous form feeds. It does not however send data to the printer: you must do that by pressing [ALT]+P.

## The good style guide

When writing your database text, sticking to a few simple rules will make it simpler for you and others to use:

- ▶ Choose names that differ in the first few letters, to make selection of suboptions easier. Avoid jargon terms, abbreviations and punctuation. Compare the 'Cartridge' topic in the HiFi example, which does badly on all these points, with the 'Amplifier' topic. Notice how the text leads on to explain what the subtopics are about.
- ▶ ASCII codes greater than 128 will

print graphics on the screen. How you get them into your text file depends on the word processor you use to create it. If you experiment, you can draw boxes and diagrams in your text.

- ▶ To print out an entire help file, don't use the LIST option as it only prints a single topic. Use the command HELP [EXTRACT] to make a text file, then load it into a wordprocessor to remove all the '///x' stuff and generally pretty up the layout. Print like any other file.

All the text used by the program HELP.COM is stored in a file called HELP.HLP. This file is specially coded, and you can't get at any of the 75k's worth of information except by using the HELP command. However, the command HELP [EXTRACT] takes the file HELP.HLP and from it produces a file HELP.DAT which contains the help data in a form that can be edited in a wordprocessor. HELP.HLP must be on the default drive, irrespective of which drive HELP.COM loaded from. Having edited the file, you can create a new HELP.HLP with the command HELP [CREATE]. Creating a new HELP.HLP file overwrites the old one without asking if you mind.

This is where it starts to get interesting, because using the CREATE option you can create your own HELP text, which needn't be anything to do with CP/M at all.

Suppose a HiFi shop wanted to produce an aid for its newer members of staff. A sound system is composed of several pieces of equipment, each of which can be divided into several component parts; some of these may be further subdivided. This is the ideal kind of application for a Help file, as shown in the diagram. The row of three boxes represents the topics that will appear on-screen ▶

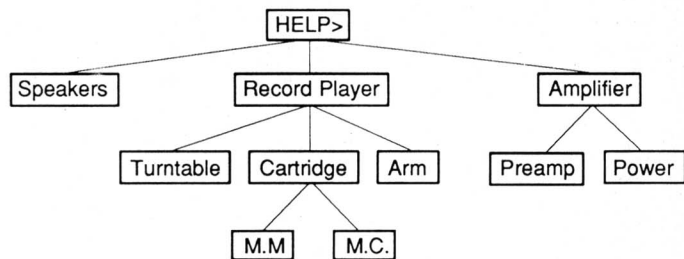

▲ The hierarchy of a HiFi system, which is ideal for putting into a HELP file

```

///1Amplifier
This is the centre of the system, and is in two parts:
///2Power
A power amp makes the signal larger to control the speakers.
///2Preamp
Selection of records, tape or tuner is done from the preamp.
It also controls the volume and tone.
///1RecordPlayer
Despite cassettes and compact disc, LP's are still the most
common means of providing music.
///2Arm
The arm allows the cartridge to move over the record.
///2Cartridge
By converting movement of the 'needle' into electrical
signals, the cartridge supplies a music signal for the preamp.
///3M. M.
Moving magnet cartridges will work with any amplifier.
///3M. C.
Moving coil cartridges may need a special transformer or
headamp to work with a standard amplifier.
///2Turntable
This provides a platform for the arm, and rotates the record.
///1Speakers
A pair of speakers allow you to hear the music!
  
```

▲ The text for the HiFi shop's example HELP.DAT file

when the program starts. If these are called 'level 1' then the next row of boxes is level 2 and represents the subtopics. The bottom row is level 3 in this example, although the HELP program can handle up to 9 levels.

## "I'd like to buy a gramophone"

Turning to the listing, you can see how to represent this information. To use the example worked through here, create a file called HELP.DAT using, for example, the 'non-document' mode in Wordstar. If you use LocoScript, select the 'simple text file' option from the 'Make ASCII file' menu on [f7]. Now type in the example text into the file. Look at the first line; firstly there are three slashes. These are not printed but indicate to the program that the name of a topic is coming up.

Then there is a single number, which is the 'level', followed by the name of the topic. Notice that there are no spaces between the number and the name, which can be up to 12 characters – including numbers and spaces. Any excess characters on that line are printed as part of the text. The information associated with that topic follows on the next line. This can be of any length, from a single word to several pages. The end of the text is marked by a line starting with three slashes, or the end of the document.

After the 'Amplifier' topic is its first subtopic, so the name is preceded by '///2'. There are no further levels on the diagram, so this is followed by the next level two topic. That being the end of this 'branch' on the diagram, we move on to the next level 1 topic. Follow through the rest of this example, comparing it to the diagram.

To convert this file, which must be called HELP.DAT, into the HELP.HLP file, you must have it on a disc which has enough free space for another file which will be slightly bigger. For example, if your HELP.DAT is 21k long, you must have 22k free on the disc before you start. When converting from one to the other, the .DAT and .HLP files must be on the same disc, and this must be the default drive.

This limits the size of file you can make to around 85k on a PCW 8256, or 320k on an 8512. Allow an extra 1k

for each 64 topics or subtopics. In this small example, disc space will not be a problem! After making sure that the original Amstrad HELP.HLP is not on the same disc, type the command

```
HELP [CREATE]
```

Topics need not be in alphabetical order – look at the screen dump of the standard HELP listing file where 'COMMANDS' is before 'CNTRLCHARS'. Sticking to an alphabetical scheme does however make things neat and easy to use. Duplicate topics do not generate any errors, but you can only select the first instance of the topic. The same subtopic name can be used with several different topics.

The text you put in the Help database can contain any character you can type (ASCII codes from 32 to 255), but don't use control codes below 32 to try and get fancy effects to move the cursor as they can mess up the indexing.

The HELP.COM file can be renamed to suit yourself, but the database file must be called HELP.HLP, so the one you make must be on a different disc to the one you get free. Alterations to the HELP.HLP file may be made by the command HELP [EXTRACT] to convert it to a .DAT format; however it is easier to keep a copy of the original HELP.DAT text file and edit that.

## What can go wrong

If you don't get things just right, you are bound to get a typically cryptic CP/M error message. Most errors are due to simple things like using the wrong drive or not having enough room on disc. A couple need some explanation:

*No HELP.HLP file on the default drive:*

This error message is badly worded. It is trying to say that both HELP.COM and HELP.HLP must be on the same disc. Whether this disc is the default one is irrelevant.

*Too many entries in Index Table. Not enough memory.*

The upper limit for index entries is around 1100 entries – you are likely to run out of disc space before this limit becomes a problem. However, the Help program will happily allow you to CREATE a help file with too many index entries, and only inform you of the mistake when you try to use it!

EXIT

▼ Using the HiFi shop's custom-built help system

```

HELP UTILITY V1.1
At "HELP" enter topic [,subtopic]...
EXAMPLE: HELP> DIR BUILT-IN
Topics available:
AMPLIFIER RECORDPLAYER SPEAKERS
HELP> █
RECORDPLAYER
Despite cassettes and compact disc, LP's are still the most
common means of providing music.
ENTER ,subtopic FOR INFORMATION ON THE FOLLOWING SUBTOPICS:
ARM CARTRIDGE TURNTABLE
HELP> █
RECORDPLAYER
CARTRIDGE
By converting the movement of the 'needle' into electrical
signals, the cartridge supplies a music signal for the preamp.
ENTER ,subtopic FOR INFORMATION ON THE FOLLOWING SUBTOPICS:
M.M. M.C.
HELP> █
RECORDPLAYER
CARTRIDGE
M.C.
Moving coil cartridges may need a special transformer or
headamp to work with a standard amplifier.
HELP> █
  
```

## Hacker note

If you don't like the blurb or error messages HELP gives you, you can change them by using SID to directly alter the file HELP.COM. The Help messages are stored at 0140h to 0583h, and they can be edited as long as the start address of each message is not altered. The 'HELP >' prompt is at 04A1h to 04A6h, and the introductory blurb is at 04C0h to 052Fh.

▲ The Official Amstrad Professional Users Club ▲

# AMSOFT AND MORE... DIRECT TO YOUR DOOR

Only the Official Professional User Club can offer you such a range of approved software from Amsoft, and other top manufacturers; and no shop could ever offer prices as low as these. But the savings don't stop here...



**£12.95**  
NON-MEMBERS  
**£9.95**  
MEMBERS

**NEW 3" DISC BOX**  
A stylish, and sturdy design, taking up to 21 discs in their cases, and providing the ideal storage environment.

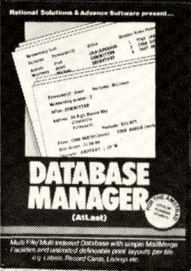

**£29.95**  
NON-MEMBERS  
**£25.45**  
MEMBERS

**DATABASE MANAGER**  
A sophisticated Database, superb for anyone who needs to merge correlate, or cross-relate files.



**£29.95**  
NON-MEMBERS  
**£25.45**  
MEMBERS

**MONEY MANAGER**  
A magnificent, and flexible personal accounts system which doubles as an inexpensive business system.

**JUST A SELECTION FROM OUR VAST RANGE**

	NON MEMBERS	MEMBERS
LOCOMAIL		
LOCOSPELL (PCW) Joint Purchase	£79.90	£61.90
3" FLOPPY DISKS (FIVE PACKS)	£13.95	£11.95
PLAN IT	£24.95	£20.95
SUPERTYPE (NEW: LATEST VERSION)	£19.95	£17.95
DATASTORE	£39.95	£35.95
NEW! CARBON RIBBONS	£4.95	£4.25
TOMA HAWK (new game for PCW)	£19.95	£16.95

**TOP GAMES GIVING GREAT FUN AND VALUE**

	NON MEMBERS	MEMBERS
SPACE INVADERS (The Classic)	£12.95	£11.00
TRIVIA (The "Boardgame")	£14.95	£12.70
BATMAN (Super 3-D Adventure)	£14.95	£12.70

ARE YOU A MEMBER OF LAWLINE? IF NOT, RING US FOR DETAILS.

**ORDER ACTION LINE · DIAL 091 5673395 NOW**

For really fast attention, order now by phone (24 hour service) quoting Access or Visa number. Or fill in the coupon below.



**WANT TO SAVE A FORTUNE ON SOFTWARE? THEN JOIN THE CLUB!**

- △ Help Hotline for any technical help you need.
- △ 12 months Free subscription to Amstrad Professional Computing Magazine.
- △ 24 hour telephone ordering facility.
- △ Free monthly newsletter.
- △ Exclusive products for club members.
- △ Privileged preview of new products.
- △ Big prize competitions.
- △ Products delivered direct to your door.

**HOW TO JOIN THE CLUB**

Simply fill in the coupon on the right and return it to us at the address shown, together with your remittance. We'll send you your special membership card, and you can start making savings straight away.

PLEASE SEND ME: NEW DISCBOX  DATABASE MANAGER  MONEY MANAGER  (TICK BOX)

Items: \_\_\_\_\_ as listed from our range.

Yes, I want to enjoy the benefits of Amstrad Professional User's Club Membership - Please enrol me today. I enclose cheque/P.O. for £39.95. Please send details to:

NAME \_\_\_\_\_ 8000 P3

ADDRESS \_\_\_\_\_



Access or Visa no: \_\_\_\_\_

Please allow up to 28 days for delivery. Offers subject to availability; all prices correct at time of going to press.

· POST TO ·  
· OFFICIAL · AMSTRAD · USER · CLUB ·  
· VICTORIA HOUSE · P.O. BOX 10 ·  
· SUNDERLAND · SR1 3PY ·



FOR OFFICIAL USE ONLY

# CF2

**GENUINE  
AMSOFT**  
INC IND. LIB. CASES

# AMS20L

★ STORES CF2 LIB. CASE ★

STORAGE BOX  
HOLDS 20 CF2  
**£9.75** inc. VAT P&P

TEN FOR **£26.95** INC VAT, P&P

FIVE FOR **£13.95** INC VAT, P&P

# PROTO

STORAGE BOX  
HOLDS 10 CF2  
**£6.49** inc. VAT P&P

## DISCOUNT PCW SOFTWARE AND BOOKS

### ADVANCE

Database Manager (At Last) ..... 23.95

Money Manager ..... 23.95

### AMSOFT

Locospell ..... 30.95

Locomail ..... 30.95

Supercalc 2 ..... 42.95

### ARNOR

Protect ..... 63.95

Prospell ..... 23.95

### BCPL

CAMSOFT

Accounts (full suite) ..... 99.99

Stock control ..... 36.95

Payroll ..... 36.95

### COMPACT

Accounts (Integrated) ..... 155.96

Sales Ledger ..... 54.59

Sales Invoicing ..... 54.59

Purchase Ledger ..... 54.59

Nominal Ledger ..... 54.59

Stock Control ..... 54.59

Payroll ..... 77.99

Nucleus ..... 77.99

Interfacer ..... 54.59

### DIGITAL RESEARCH

Dr Draw ..... 43.95

Dr Graph ..... 43.95

Dr Pascal ..... 43.95

Dr C Basic ..... 43.95

### ASHTON-TATE

dBase II ..... 89.95

### IANSYST

Iankys Touch Typing ..... 21.49

### MICROPRO

Pocket Wordstar ..... 37.45

Wordstar Deluxe ..... 48.95

### MICROPOWER

Dataflow III Mailflow III ..... 39.95

### QUEST

Cash Trader (Trial Copy) ..... 19.95

Cash Trader (Working) ..... 69.95

Cash Trader + Analyser ..... 99.95

### SAGESOFT

Popular Accounts ..... 82.24

Popular Accountns pLus ..... 112.50

Popular Accounts Combo ..... 112.50

Polular Acc Combo Super ..... 168.99

Popular Invoicing ..... 56.86

Popular Payroll ..... 56.86

E. Mail ..... 55.96

Magic Filer ..... 49.95

Retrieve ..... 56.86

### MISC

Tasword 8000 ..... 21.00

Tasprint 8000 ..... 21.00

Supertype ..... 17.95

Delta (Database) ..... 79.20

Landscape (Sideways Print) ..... 19.95

Caxton Brainstorm ..... 42.95

Signwriter (PCW) ..... 40.96

### MISC (cont.)

Locoprint (Daisy Wheel Software) ..... 37.95

Locoprint + CPS 8256 Int. .... 95.75

Electric Studio Light Pen ..... 65.56

Electric Studio Mouse ..... 106.56

Microfile/Microword ..... 29.95

### NEWSTAR

Newword 2 ..... 59.80

Cracker 2 ..... 44.95

### MIRRORSOFT

Fleet St. Editor ..... 57.36

G.O.S. .... 55.00

### MORE MISC!

Plan It ..... 21.95

Saxon Flexilabel ..... 27.95

### SHAREMASTER 2

Accounts ..... 134.96

Accounts + Stock ..... 179.96

Acc. + Stock + Costing ..... 269.96

File Manager ..... 89.96

Payroll ..... 71.96

Accounts + Payroll ..... 179.96

Glue ..... 89.96

### EVEN MORE MISC!

Rotate ..... 21.95

Daisy Disc ..... 17.95

PCW Dust Covers (canvas) ..... 9.95

### BOOKS (PCW)

Amstrad CP/M Plus ..... 12.95

Amstrad Comms ..... 8.95

Amstrad Word Proc ..... 8.95

Hitchhikers Guide ..... 6.95

Mastering 8256/8512 ..... 8.95

Program your PCW ..... 6.95

Using the PCW ..... 9.95

Advanced Amstrad Basic ..... 12.95

SAE for full list of computer books

### GAMES (PCW)

Tau Ceti ..... 17.95

Trivial Pursuit ..... 17.95

Batman ..... 12.95

Lord of the Rings ..... 19.95

3D Clock Chess ..... 13.95

Bridge Player 3 ..... 17.95

Hitchhikers ..... 19.95

### ORDERING

Post your order with  
cheque or P.O.

Phone your order with  
credit card

Official orders welcome  
Orders despatched by 3.20pm

ALL PRICES INCLUDE 15% VAT AND P&P

0788  
71643

**RUGBY MICRO SPARES**  
30 OXFORD STREET  
RUGBY CV21 3NF

8AM  
9PM

Telex  
312242 MIDTLX G

## AMSTRAD ?

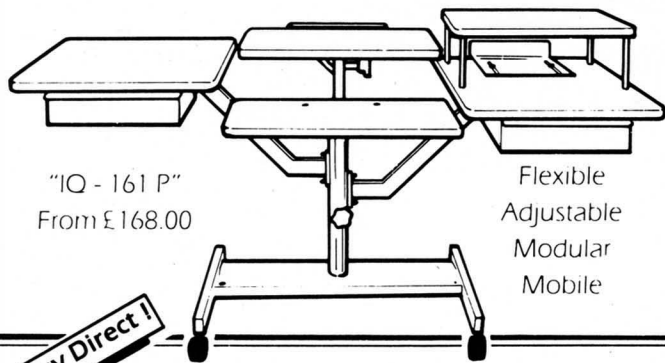

"IQ - 161 P"  
From £168.00

Flexible  
Adjustable  
Modular  
Mobile

Buy Direct!

We've got your ergonomic  
**WORKSTATION.**

The IQ 161 Series  
from £108.00

**IQ's For Amstrad and you know Whose**

**The Worlds most versatile VDU Arm only £128.00**

### Free Colour Brochure

Intelligent Quotient (IQ) Ltd.  
45 Epping Close  
Romford RM7 8BH  
Tel: 062-780331  
0836-261-800

### Showroom

Ascot Court  
71 - 73 Middlewich Road  
Northwich  
Cheshire

Call Now

## CARD FILE IN A MESS? CHIBASE has the answer!

### CHIBASE From CHIASMA SOFTWARE SYSTEMS

CHIBASE works like a **NOTEBOOK** with an index

CHIBASE is an easy way to store and recall text notes on disc.

CHIBASE has all the features needed to store and recall HUNDREDS of text 'pages' on your PCW8256 or PCW8512 computer.

CHIBASE is used by **RESEARCHERS INDUSTRIALISTS STUDENTS TEACHERS AND OTHERS.**

Just some of the **CHIBASE** features:

- **Works like a notebook:** 'pages' are found by means of **keywords** in an index.
- Just type in your text using the simple screen which has some basic word processor facilities. Or use your **word processor** to lay out your (English) text then transfer to Chibase. You can also re-export English from Chibase to your word processor.
- **On-Screen highlighting** to indicate **keywords** which will go into the index. A single keystroke highlights the word which is at or just before the cursor position. Up to 50 keywords on a 'page'.
- **Fast and easy** to use: no complicated syntax to learn.
- **Free format** text up to 23 lines of 80 characters on a 'page'.
- **No tiresome** setting up of record fields.
- You can optionally set up **forms** to help you enter text. A form works just like a paper form. Use the **TAB** key to move between the parts of the form. The TAB character can be changed at any time, so you can more easily enter different kinds of information on the same 'page'.
- **Database** commands are given by pressing a single key.
- **Editor** commands are mostly set to logical word processor keys.
- **High capacity** achieved by text compression and variable length records (pages). Capacity depends only upon the total amount of text stored on the database.

**PRICE £49.95 inc.**

**CWMBRAN COMPUTER CENTRE**  
(dept. 8000), 3-4 Ventnor Rd., Old Cwmbrian, Gwent.  
Phone (06333) 60996 or (02814) 3716  
Access/Visa welcome

If you're in the area, why not drop in for a free demonstration?  
open Mon-Thurs 1.30-8.00 Sun 10.00-1.00

ONLY THE BRAVEST FLY....

# TOMAHAWK<sup>®</sup>



## AMSTRAD

BY D.K. MARSHALL  
ADAPTED BY DARRELL D.

**TOMAHAWK** – a stunningly realistic flight simulation that puts you in command of an Apache Advanced Attack helicopter. Flying low over a spectacular 3D real world display with over 7000 ground features – **TOMAHAWK** puts you in the hot seat.

Ground attack and air-to-air interception is the challenge – day or night in the thick of the battlefield. Your combat mission is to locate and destroy enemy ground forces. It could be science fiction – it isn't – the Apache is for real.... the meanest, deadliest combat helicopter ever. You have the weapons, the machine.... climb in and prepare for take off!

- Spectacular 3D cockpit view with over 7,000 ground features.
- Authentic aerobatic performance.
- Ground attack and air-to-air interception, with laser guided missiles, rockets and 30 mm gun.
- Doppler navigation and target tracking.
- Day/Night vision systems.
- Cloudy, Crosswinds, Turbulence.
- Pilot ratings – Trainee to Ace.
- Impressive sound effects. (CPC ONLY)
- Pilots Notes.

**TOMAHAWK**  
THE DEFINITIVE  
HELICOPTER SIMULATION  
NOW AVAILABLE ON  
THE AMSTRAD PCW  
8256/8512



CPC Screen Pics

FOR ALL THE AMSTRAD CPC AND PCW RANGE

### SPECTRUM

- TT Racer 48/128K  £9.95
- Tomahawk 48/128K  £9.95
- Fighter Pilot 48K  £7.95
- Night Gunner 48K  £6.95

### COMMODORE 64

- Fighter Pilot  £9.95
- Fighter Pilot Disk  £14.95
- Tomahawk  £9.95
- Tomahawk Disk  £14.95

### ATARI

- Fighter Pilot  £9.95
- Fighter Pilot Disk  £12.95
- Tomahawk  £9.95
- Tomahawk Disk  £14.95

### AMSTRAD CPC 464, 664, 6128

- TT Racer  £9.95
- TT Racer Disk  £14.95
- Night Gunner  £7.95
- Night Gunner Disk  £13.95
- Tomahawk  £9.95
- Tomahawk Disk  £14.95
- Fighter Pilot  £8.95
- Fighter Pilot Disk  £13.95

### AMSTRAD PCW 8256/8512

- Tomahawk Disk  £19.95

VAT and p.&p. inclusive within UK  
(overseas inc. 55p per cassette)

Tele Sales  
(0276) 684959



Please debit my Access/Visa card no.

\_\_\_\_\_

Expiry date \_\_\_\_\_

Cheques made payable to Digital Integration Ltd

I enclose a cheque/P.O. for \_\_\_\_\_ Total

Name \_\_\_\_\_

Address \_\_\_\_\_

Please send to

**DIGITAL  
INTEGRATION**



Watchmoor Trade Centre,  
Watchmoor Road,  
Camberley, Surrey  
GU15 3AJ

**Trade and Export enquiries  
welcome. Lifetime Guarantee.**

# CHAIN LETTERS

In his final article, John Hughes ties strings together and puts them into loops

In part 4 we saw it was possible to join string variables together - to concatenate them - by putting a plus sign, '+', in between the variable names, turning "Good" and "morning" into "Goodmorning", for example. In this article we shall look at some of the other things which can be done with strings, and the different techniques which Locomotive BASIC offers for handling them.

To begin with, we shall look at the sort of comparisons which BASIC can perform on strings. Program 1 shows how a very simple comparison can be performed; two strings are input and are then compared with each other, and the program prints a suitable message to say whether they match.

The actual comparison is done in Line 60, using a simple IF command, extended with the ELSE keyword, which means 'otherwise' - that is, if the first string is the same as the second string, then the program will print 'They're the same'; otherwise it will print 'They're different'.

Type in the program and try it out to see how it works. There's actually no need to restrict yourself to single words, because a string can be of any length up to 255 characters. After a few tries, you'll realise that in BASIC, strings are 'equal' only if they are precisely the

```
10 REM Program to compare strings
20 PRINT "Type in a word"
30 INPUT FIRST$
40 PRINT "Type another word"
50 INPUT SECOND$
60 IF FIRST$=SECOND$ THEN PRINT "They're the same" ELSE PRINT
  "They're different"
70 END
```

```
60 IF FIRST$<SECOND$ THEN PRINT "The first string is less than the
second string"
```

Program 1

## ASCII nicely

The ASCII Code is one of the few real international standards in computing; big computers sometimes go their own way, but micros like the PCW almost invariably follow it.

Every printable character is assigned its own number between 32 and 127, and numbers below 32 are allotted to 'control characters' such as LF (Line Feed), CR (Carriage Return) and BEL (the Bell). You can get to some of these directly from BASIC; try PRINT CHR\$(7) and the Bell (actually the bleeper) will sound; 7 is the ASCII Code for BEL.

Many systems use codes between 127

and 256 for their own purposes; these aren't true ASCII, so they vary between different makes of computer; they are often used for accented characters, Greek letters and the like; even the Pound sign is a non-standard character, because ASCII is an American code, and they never bothered to incorporate foreign currency symbols!

Character 127 is something of a maverick too; many computers print it either as a blank, a black rectangle or a chequer pattern, but the PCWs print it as a zero, as you can see.

same in every way. The slightest difference, such as an extra space, or even using lower case letters instead of capitals, and BASIC will see them as different.

### "TO BE" is less than "to be"

If strings are equal, can they also be 'less than' or 'greater than' each other? The answer is that they can, as you will see if you modify Line 60 of Program 1 to read as follows: `60 IF FIRST$ < SECOND$ THEN PRINT "The first string is less than the second"` (You may remember that the symbol '<' means 'less than'.)

Try the modified program out with a few pairs of single letters, such as 'a' and 'A', and 'A' and 'B', and then with pairs of words such as FRED and FRED A. The more you experiment with this, the more you will find out about how BASIC handles strings, so don't be tempted to rush things.

When you have finished your explorations, you will probably have discovered that BASIC has three main rules for comparing characters: basically, capital letters are always 'less than' lower case letters; between pairs of letters which are both capitals or both lower case the earlier the letter comes in the alphabet, the lower its value; and between words such as FRED and FRED A, the shorter word is 'less than' the longer one.

The explanation for all these rules is simple enough: every character is assigned a special number called its ASCII number; ASCII (pronounced 'Askey') stands for the American Standard Code for Information Interchange, and a copy of the code is printed here.

What BASIC really means by a character being 'less' than another character is that its ASCII Code is less than the ASCII Code of the second character. A string is equal to another string if every ASCII code in each string is the same.

### ASC and CHR\$

There are two related keywords which are very useful in handling characters; they are ASC (which is obviously an abbreviation for ASCII) and CHR\$.

If you look at the listing of the ASCII printable characters, you will see that it was produced by using a FOR-NEXT loop and CHR\$. CHR\$ is almost always used with PRINT, and the function outputs the character whose ASCII value is put in brackets after the keyword.

For example, PRINT CHR\$(65) will put a capital 'A' onto the screen; PRINT CHR\$(42) will output an asterisk, and so on. You can output 'non-printable' characters in the same way; PRINT CHR\$(7) will make the speaker beep, for example, and PRINT

```
10 PRINT "Input a string in small letters"
20 INPUT YOUR$
30 MY$=UPPER$(YOUR$)
40 PRINT "You typed ";MY$
50 END
```

Program 2

CHR\$(13) has the same effect as pressing [RETURN].

Before you experiment too much with this, make sure that you have saved any program you have been working on onto disc, because some of these non-printable characters have special meanings and can cause some odd side-effects.

ASC is used to find out what the ASCII code of any specified character is; it is thus the complement of CHR\$. The form of it is PRINT ASC(string) where string is any character or group of characters. What will be printed out is the ASCII Code of the character in the brackets - or the value of the first character, if there are more than one.

For example, to find out the ASCII value of '&' you would type PRINT ASC("&") and to find the code of 'A' you would type PRINT ASC("A"). It is very easy to get ASC and CHR\$ mixed up with each other, so don't worry too much if you find that you confuse them at first.

## Going up to the Capital

We humans treat upper and lower case characters like "b" and "B" as substantially the same and the fact that BASIC does not handle them in this way can be rather a nuisance at times.

```
50 ANSWER$=UPPER$(INKEY$):IF ANSWER$="" THEN 50
60 IF ANSWER$="Y" THEN 100
```

**Program 3**

We have already seen one example of this sort of problem in Program 4 of the fourth part of this series. You may remember that we asked whether a particular list was to be output on the printer or not, and then tested whether either "y" or "Y" had been pressed. This rather clumsy approach is necessary because a user of the program might press "Y" and have their entry misunderstood if the program was arranged only to accept "y".

Fortunately, BASIC has a pair of commands with which strings can easily be changed into either upper or lower case letters. The two commands are UPPER\$ and LOWER\$. The first converts a string to capital letters, and the second converts a string to lower case; characters other than letters are not affected by these commands.

The way they work is shown in Program 2; this asks for an input in lower case letters, and promptly converts this into capitals before printing it. Any characters which were in upper case to begin with are unaffected.

Look at the syntax of the UPPER\$ command to see how it works - the name of the string to be converted is enclosed in brackets immediately following the keyword UPPER\$. LOWER\$ is used in exactly the same way, so you should find it easy to rewrite the program to use it.

UPPER\$ and LOWER\$ are particularly useful in alphabetical sorts - perhaps in a payroll program or perhaps as a preparation to carrying out a spelling check on a document. You can also use them when testing for a response of the 'Press 'Y' to print the document' type. Program 3 shows what a segment of such a program might look like.

## On the menu

Menus, as you will certainly be aware if you have used LocoScript, are not just semi-fictional descriptions in dubious French of the dishes a restaurant is trying to unload on its clientele. Rather, they are lists of all the options available to you at some point in a computer program.

There are two ways of making a choice from a menu. Either a cursor bar is moved up and down the menu to rest on the desired option (as in LocoScript), or the user is asked to enter a letter or number corresponding to the required choice.

Program 4 shows how a menu might be used as part of a program; don't let the extreme simplicity of this menu it only has two choices! - blind you to the way it works.

First of all, a FOR-NEXT loop has been used to print ten blank lines in order to position the menu tidily in the middle of the screen. This may seem rather unnecessary, but a tidy screen display is one of the hallmarks of professional programming. In the same way, the two options have been tidily spaced in from the left edge of the screen. And note the prompt at the bottom, so that you are in no doubt at all about what you are meant to do.



Only single-key responses are required, so we have used INKEY\$; this simplifies things for the non-expert, who doesn't need to remember to press [RETURN]. If no key is pressed, the program will circle round Line 140 waiting for a key. When a key is finally pressed, the value of it is converted to upper case by UPPER\$; this makes the comparisons in Lines 150 and 160 easier to program.

There is also a 'mug trap' in Line 170 to catch the wise guy who presses neither the "E" nor the "L"; if neither of these keys is pressed, the control goes back to Line 140, and another key press can be made.

This program won't work properly as it stands, simply because Lines 200 and 1000 are missing, so there is nowhere for it to go if "E" or "L" is pressed; but apart from that it is quite OK, and should give you a sensible structure for your own menus.

Incidentally, the Leave Program option *could* just have an END command in Line 160. However, it makes a program much easier to follow if the END statement is placed at the end of the program. EXIT

## Goodbye

This completes John Hughes' BASIC series. Further instruction can be found in the Listings section each month, and specific language topics will continue to be covered on an occasional basis.

```
10 REM A Sample Menu
20 REM 8000 Plus
30 CLS:CHR$(27)+"E"+CHR$(27)+"H"
40 PRINT CLS$
50 FOR POSITION% = 1 TO 10
60 PRINT
70 NEXT
80 PRINT "                E      Enter Data"
90 PRINT
100 PRINT "                L      Leave Program"
110 PRINT
120 PRINT
130 PRINT "                Press the appropriate letter to make
your choice"
140 answer$=UPPER$(INKEY$):IF ANSWER$="" THEN 140
150 IF ANSWER$="E" THEN 200:REM section of program for entering data.
160 IF ANSWER$="L" THEN 1000:REM leaving program.
170 GOTO 140
```

**Program 4**

# Round Up

In the last six parts of BASIC PLUS, we've started from scratch with loading Mallard BASIC and using it as a calculator in 'immediate' mode. Since then we've covered the following topics:

- ▶ The BASIC line editor
- ▶ The use of variables, and how to display their contents on the screen
- ▶ Taking input from the user of your program
- ▶ Loading, running and saving a BASIC program
- ▶ Remarks, and how to make them unobtrusively
- ▶ Branching from one place in a program to another
- ▶ The difference between strings of characters and numbers, both integer and real
- ▶ Passing through a section of program more than once - looping
- ▶ Comparing and manipulating strings
- ▶ The ASCII code system for computer characters
- ▶ Creating a 'menu' within a program to handle multiple choices

# LANGFORD'S PRINTOUT

A page foolishly handed over to SF author DAVID LANGFORD who just happens to own an AMSTRAD



Last issue I tried to be provocative and have duly received 5,271,009 outraged letters from those who felt insulted – ie all software dealers, all software users, and most small-press publishers. I didn't mean to offend the latter: the point was that very small publishers can't afford economies of scale and have to charge more than one might expect. Little did your columnist realise that one of the Old Barn hacks was also part of the tiny but classy SF publishing outfit Kerosina Books. Ben Taylor has gently remonstrated with me: I expect to be out of hospital any week now.

After explaining last issue how to irritate the people who flog software, it's only fair to tell them how to annoy you right back. Here, then, are ten tried and tested ways. Mind you, I have this terrible suspicion that the big software dealers know them all already...

1) With PCW programs, always send the manual for the IBM version. A good ploy is to include a note saying, approximately, 'Because you bought a miserable cheapo computer, you cannot use the triffic features described in chapters 7-15 inclusive.' A sprinkling of references to PC-DOS (the IBM operating system) commands will complete the process of demoralization.

2) When someone rings your Technical Support department, always put them on hold for at least twenty minutes and play horrible tinkly music to them. Since few people can afford Musak at peak telephone rates, this weeds out a lot of time-wasting queries.

3) Always put at least two files on the disc which aren't mentioned in the manual (and omit one that is). Keep the customer worried and off-balance.

## TURNING THE TABLES

4) Never call a bug a bug. Good alternatives are: 'disc drive fault', 'probable user error' and 'quirk of CP/M'. When cornered, fall back on 'undocumented feature'. This last term arises from the well-known fact that as soon as a *bug* is documented in the manual, it becomes a *feature*. Thus: 'A convenient feature of the Grottyscript word processor is that you can reset the computer to power-on status at any time by simply pressing the space bar'.

5) Establish dominance by making it clear to the customer that he or she is *very* ignorant. "You mean you've been using the PCW for three whole weeks and still don't know about RS-232 interface disc compiler mode I/O synchronicity overlay protocol debug incompatibility? We do have to assume *some* elementary knowledge, you know...."

6) Be suspicious! This fellow who's rung with all the awkward questions obviously can't be a bona-fide user of your software if he's unable to quote (from memory) the full 64-character registration reference included with each package. Of course it hardly needs to be mentioned that this reference should be on a small,

separate, easily mislaid piece of tissue paper, about the size of a bus ticket.

### Waiting for Godot

...or rather, waiting for Loco. By the time this *8000 Plus* hits the stands I hope to know the answer to the tormenting question raised by last issue's piece on LocoScript 2. Locomotive's marketing manager revealed that Loco 2 would be incompatible with all sorts of existing add-on software, ho ho, but coyly failed to answer the 64 kilobyte question: how easily will it read LocoScript 1 document files? I wait in fear and trembling.

7) Point out that although your advertisements do indeed promise full telephone support and advice, available 24 hours a day, the technical support team lives at the head office. "Just dial this Los Angeles number..." It's equally useful to insist that free program upgrades (i.e. to improved versions where the bugs have been cured or at least moved around a bit) are available only on sending the

original disc and manual, in the original-massive box, by registered air mail to Cincinnati.

8) A refinement of point (3) is to omit a vital step from the manual ("It is essential to press SHIFT-EXIT-PASTE twice and give a Masonic handshake in order to exit the Smartass information menu") and hide it in a disc file. Most people have sussed READ.ME files, so call it something like PRGMANI.MSG and *don't use LocoScript format*. The standard format for such files is WordStar's, since the ASCII text will then be full of funny characters which make it unreadable to non-WordStar users, har har.

9) Why waste time looking for bugs in your programs when thousands of customers are eager to do it for you? If the accounts package doesn't round up the VAT properly, try it on the public anyway: there's always the chance that no-one will notice, in which case you needn't correct the program. At least, not until the VAT inspector has hauled a few customers off to jail: but there are plenty more where they came from.

10) The Amstrad manuals tell people how to run SET24X80, load the specialist keyboard needed by your software, and use the CP/M program PIP to copy stuff to the M: disc as also required by your software. People with quite poor degrees in computer science have often been able to master the manual's descriptions of these processes in as little as six months. So when producing your own instructions, there's no need to explain how any of this is done. Paper costs money. Your ideal is a manual which will fit on one side of A4. Indeed, 'Run the program' should be enough for anyone: after all, your software is self-explanatory, with lots of helpful messages like 'ERROR TYPE B34F DISK CALL BDOS ??? FILE ???????.\$\$\$ Aborted'.

These ten points are easy to master, and when you've done so you'll be well on the way to being a real, professional software manufacturer. Of course there are many further subtleties, like the importance of advertising your new product and getting in lots of cash orders before you start writing the program: but such techniques of 'Advanced Cliveism' are beyond the scope of an elementary article. Fair's fair. I've demonstrated how to annoy both dealers and customers. Next month, we'll discuss methods of annoying computer magazine editors. (*I don't know whether I can narrow it down to 10 - Ed.*)

# JON RITMAN AND BERNIE DRUMMOND PRESENT DOUBLE TROUBLE...



**\*ENTHRALLING\*COMICAL\*DAZZLING\***

Hi! My name's Mr. Head. Some say I'm the one with the brains but I don't think my flat footed friend would agree. I'm a real sharp shooter, but without my pal Mr. Heels I'd get nowhere fast... or slow! I can jump like a flea and even glide but Heels is the Daley Thompson of the two of us - he's FAST! Together, if we can find each other, we really do make an awesome twosome, and that's the only way we can overcome the emperor Blacktooth. The last time we entered Castle Blacktooth we found the crowns of THREE of the suppressed kingdoms but by that time I'd run out of doughnut ammunition and my buddy was lost somewhere in the Safari world - it was the closest we had come to defeating that rapscallion - we were jumping for joy, splitting our sides, dying with laughter... we were Head over Heels!

AMSTRAD PCW

SPECTRUM

MSX

COMMODORE

**£14.95**

**£7.95**

**£8.95**

**£8.95**

AMSTRAD

**ocean**

Ocean Software · 6 Central Street · Manchester · M2 5NS  
Telephone: 061 832 6633 · Telex: 669977 Oceans G

# TWIN DISK SIMULATION!

FEATURING...

  
**Heathrow**  
AIR TRAFFIC CONTROL

AND...

**SOUTHERN BELLE**

TAKE THE FOOTPLATE  
OF THIS FAMOUS STEAM  
LOCOMOTIVE!

2 EXCITING TRAVEL SIMULATIONS  
FROM PAST & PRESENT!

**HEWSON**

Hewson Consultants Ltd.  
56b Milton Trading Estate, Milton,  
Abingdon, Oxon. OX14 4RX.

**AMSTRAD**  
PCW 8256 & 8512  
£16.95

## TWO COLUMN PRINTING

by Alan Hepworth

After several TIPOFFS on printing a LocoScript document in two columns, here is a BASIC solution from Alan Hepworth of Radstock. The program takes your LocoScript document and prints it in two columns in one run. More importantly, it comes out perfectly aligned (not easy with the old dual pass method) and even prints the correct page number at the bottom.

The listing works on an ASCII file, so you lose all LocoScript's fancy type commands, but you can't expect everything from 47 lines of Basic. Type in the listing and save it to disc before preparing your LocoScript document.

It's a good idea to start by creating a TEMPLATE.STD for a new LocoScript group to keep all your double column writing in. Create a document called TEMPLATE.STD and press [F7] twice. The menu that appears asks about page lengths. Set the page length to 66, the header zone to 0:Position 1 and the footer zone to 11:Position 62. This should give a page body of 55. EXIT from this menu and press F1 to set the layout. Set

# TWO BY TWO

Build your own columns with our two-column printer, or illustrate your thesis with a graph.

the margins to 0 and 37 and the pitch to 12 and the template is complete.

Write your article without bold, underlining or anything fancy like that and make sure the last line of your document isn't blank.

Save it and then use [F7] to 'Create an ASCII file', making sure to choose the 'Page Image' option and save the resulting file in group 0 (CP/M, and therefore BASIC, normally only deal with files in this group).

Load BASIC and run the program. It will ask for the LocoScript file name and the number of lines on the page (between one and 55). You have the choice of printing out immediately or seeing it on screen first to make sure it looks right (use [ALT]S to stop and continue the scrolling). The program is set to Draft Elite but you can set Near Letter Quality in the normal way, using [PTR].

```

10 CLEAR : esc$=CHR$(27) : cls$=esc$+"E"+esc$+"H"
20 LPRINT esc$;"@";esc$;"M";esc$;"d"
30 PRINT cls$ ;"TWO COLUMN PRINT OF A LOCOSCRIPT PAGE IMAGE ASCII FILE"
40 PRINT : INPUT"Filename = ",name$
50 IF FIND$(name$)="" THEN PRINT"Cannot Find.- Try again":GOTO 40
60 PRINT:INPUT"Maximum lines per page. (1 to 55) = ",num
70 IF num < 1 OR num > 55 THEN 60
80 PRINT : PRINT"Press V to view on screen or P to Print"
90 select$=UPPER$(INKEY$):IF select$="" THEN 90
100 IF select$ = "V" OR select$ = "P" THEN 110 ELSE 90
110 PRINT cls$:PRINT"Opening file :- ";name$ : PRINT
120 IF select$="P" THEN GOSUB 400
130 :
140 lines=0 : page=1 : OPEN "I",1,name$
150 DIM a$(110)
160 WHILE NOT EOF(1) AND lines < num*2
170 lines=lines+1
180 LINE INPUT #1,a$(lines)
190 IF LEFT$(a$(lines),1)=CHR$(12) THEN GOSUB 430
200 WEND
210 lines=lines-1
220 IF lines < (num * 2) THEN GOSUB 460
230 IF num=0 THEN CLOSE 1 : ERASE a$ : GOSUB 410 : GOTO 330
240 FOR x=1 TO num
250 PRINT TAB(5)a$(x);TAB(45)a$(x+num)
260 NEXT x
270 IF select$="V" THEN PRINT:GOTO 290
280 FOR k=1 TO 57-num:PRINT:NEXT k
290 PRINT TAB(41-(page < 10))page; CHR$(12)
300 lines=0 : page=page+1 : ERASE a$
310 GOTO 150
320 :
330 PRINT"Press R to re-use same file, N for a new file, or F to finish"
340 zz$=UPPER$(INKEY$):IF zz$="" THEN 340
350 IF zz$="R" THEN PRINT cls$ : PRINT"Filename = ",name$ : GOTO 60
360 IF zz$="N" THEN 30
370 IF zz$="F" THEN PRINT cls$:NEW
380 GOTO 340
390 :
400 POKE 8793,234 : RETURN
410 POKE 8793,239 : RETURN
420 :
430 c%=LEN(a$(lines))-1
440 a$(lines)=RIGHT$(a$(lines),c%): RETURN
450 :
460 num=INT(lines/2)
470 IF lines/2 <> num THEN num=num+1
480 RETURN

```

# GRAPHS PACKAGE

by W Derrick

If a picture is worth a thousand words then a graph of your data must be worth a couple of thousand (*we don't pay for graphs, though - Ed*) We know you don't like your listings too long but here is a graphs program that may be worth the effort.

The only way to get a hard copy is to take a screen dump (EXTRA and PTR) and perhaps the labelling is a little limited, but it does provide an easy-to-use method of producing bar charts, scatter graphs or distribution curves that looks impressive on screen and in print. The graphs show each entry as a percentage of the total and various statistics, including average percentage, total, average and mean, are shown grouped in the top right hand corner of the display. You could use this program as a sub-routine in your own programs to churn out figures in a really professional form.

The program is very easy to use, but remember not to use negative numbers or numbers over 99. As you can

see, the listing is rather complicated, but if you take care and work through it systematically you will be delighted with the results.

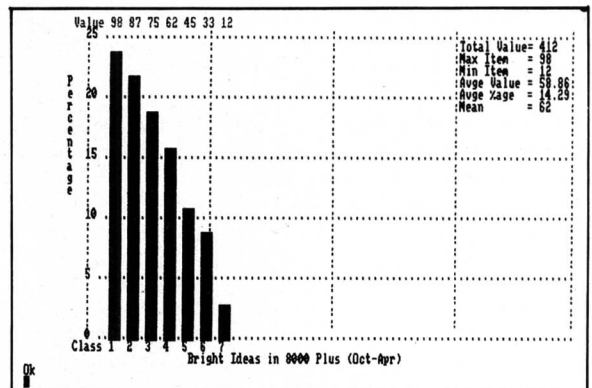

```

10 e$=CHR$(27):cls$=e$+"E"+e$+"H":wh=0:p$=e$+"Y":rv$=e$+CHR$(112):xrv$=e$+CHR$(113)
20 PRINT cls$:PRINT e$;"f";e$;"0"
30 LINE INPUT "Graph Title (max 80 ch'ters) ",t$
40 PRINT e$;"f";e$;"0"
50 PRINT:INPUT "Number of items (max 25) ",n:PRINT cls$: DIM a(n),b(n)
60 PRINT "Do you want (B)ar Chart - (S)catter Graph - (D)istribution Curve? ";
70 w$=INPUT$(1):w$=UPPER$(w$)
80 IF w$="B" OR w$="S" OR w$="D" THEN PRINT cls$:GOTO 90 ELSE PRINT cls$:GOTO 60
90 PRINT "Entry of data ":PRINT:FOR x=1 TO n:PRINT"Item no ";x;
100 INPUT " ",a(x):b(x)=a(x):wh=wh+a(x):NEXT
110 PRINT cls$:IF w$="D" THEN GOSUB 420
120 FOR x=1 TO n:PRINT p$;CHR$(32);CHR$(40);"Value";p$;CHR$(32);CHR$(42+3*x);b(x):NEXT
130 FOR q=1 TO n:a(q)=INT((a(q)/wh)*100):NEXT
140 FOR m=1 TO n:hp=MAX(hp,a(m)):NEXT
150 IF hp<25 THEN rg=25:f=1
160 IF hp>=25 AND hp<50 THEN rg=50:f=2
170 IF hp>=50 AND hp<75 THEN rg=75:f=3
180 IF hp>75 THEN rg=100:f=4
190 z=b(1):FOR m=1 TO n:h=MAX(h,b(m)):z=MIN(z,b(m)):NEXT:IF rg<=50 THEN rgr=5 ELSE rgr=10
200 FOR rr=33 TO 58 STEP 5:FOR bb=10 TO 90:PRINT p$;CHR$(rr);CHR$(32+bb);".":NEXT:NEXT
210 FOR cc=42 TO 122 STEP 20:FOR bb=1 TO 25:PRINT p$;CHR$(32+bb);CHR$(cc);".":NEXT:NEXT
220 FOR bb=1 TO 26 STEP rgr:PRINT p$;CHR$(32+bb);CHR$(42-1);rg-((bb-1)*4*rg/100):NEXT
230 IF w$="B" THEN 240 ELSE IF w$="S" THEN 270 ELSE 290
240 FOR x=1 TO n:FOR r=(58-((INT(a(x)/f))+0.5)) TO 58
250 PRINT rv$;p$;CHR$(r);CHR$(42+1+3*x);" ":NEXT:PRINT xrv$:NEXT
260 GOSUB 470:GOTO 370
270 FOR x=1 TO n:r=(58-((INT(a(x)/f))+0.5)):PRINT p$;CHR$(r);CHR$(42+1+3*x);"*":NEXT
280 GOSUB 470:GOTO 370
290 PRINT p$;CHR$(34);CHR$(103);"Total Value=";wh;p$;
300 PRINT CHR$(35);CHR$(103);"Max Item =" ;h;p$;
310 PRINT CHR$(36);CHR$(103);"Min Item =" ;z;p$;
320 PRINT CHR$(37);CHR$(103);"Ave Value =" ;USING "###.###";wh/n:PRINT p$;
330 PRINT CHR$(38);CHR$(103);"Ave %age =" ;USING "###.###";(wh/n)*100/wh
340 PRINT p$;CHR$(39);CHR$(103);"Mean Value =" ;b(n/2)
350 FOR x=1 TO n:FOR r=(58-((INT(a(x)/f))+0.5)) TO 58
360 PRINT rv$;p$;CHR$(r);CHR$(43+3*x);" ":NEXT:PRINT xrv$:NEXT
370 FOR x=1 TO n:PRINT p$;CHR$(32+27);CHR$(42+3*x);x:NEXT
380 FOR t=5 TO LEN("Percentage")+5:PRINT p$;CHR$(32+t);CHR$(39);MID$("Percentage",(t-4),1):NEXT
390 PRINT p$;CHR$(32+27);CHR$(40);"Class";
400 PRINT p$;CHR$(32+28);CHR$(32+(INT((90-LEN(t$))/2)));t$;e$;"e"
410 END
420 s=1:flag=1
430 WHILE flag=1 AND s<n:flag=0
440 FOR v=1 TO n-1:IF a(v)<a(v+1) THEN SWAP a(v),a(v+1):SWAP b(v),b(v+1):flag=1
450 NEXT:s=s+1
460 WEND:RETURN
470 PRINT p$;CHR$(34);CHR$(103);"Total Value=";wh;p$;
480 PRINT CHR$(35);CHR$(103);"Max Item =" ;h;p$;
490 PRINT CHR$(36);CHR$(103);"Min Item =" ;z;p$;
500 PRINT CHR$(37);CHR$(103);"Ave Value =" ;USING "###.###";wh/n
510 PRINT p$;CHR$(38);CHR$(103);"Ave %age =" ;USING "###.###";(wh/n)*100/wh
520 GOSUB 420:PRINT p$;CHR$(39);CHR$(103);"Mean =" ;b(n/2)
530 RETURN

```

# EASTER

by Robert Ainsley

On the theory that it is impossible to work out the date of Easter without a computer, we rush to oblige. Maybe it's just that time of the year but we have had a sudden rush of programs to perform this most mysterious of computations. The one we've chosen seems the most comprehensive. It even tells when Easter Monday is – how's that for advanced computer technology.

After lengthy discussions with some of our readers on the introduction of the Gregorian Calendar in England, Scotland and Italy, we face the prospect of another dates listing with fear and trepidation. So let us state that as far as we know this program would not know a Gregorian

Calendar if it got one for Christmas.

Mr Ainsley in his comments refers cryptically to 'an incredibly obscure formula for finding the date of Easter for any year from 1583 to 2500 due to some astronomer whose name I can't remember'. He claims that the program will work out dates from 1800-2000. We know for a fact that it works for 1987 but take no responsibility beyond that.

It's most important to remember to watch for the back-slashes used at various points. This is produced with [ALT] and [1/2] and is not to be confused with boring old '/'.

```

10 INPUT "What year do you require the Easter dates for";y%
20 m%=203:d%=12
30 IF y%<1900 THEN 70
40 m%=204:d%=13
50 IF y%<2100 THEN 70
60 d%=14
70 a%=y%-19*(y%\19)
80 q%=y%\4
90 z%=m%-(11*a%)
100 c%=z%-30*(z%\30)
110 IF c%=28 THEN c%=27
120 IF c%=29 THEN c%=28
130 h%=y%+q%+c%-d%
140 e%=h%-7*(h%\7)
150 easter%=26+c%-e%
160 PRINT:PRINT "In";y%;"Good Friday is on";
170 GOSUB 230
180 easter%=easter%+2:PRINT SPC(8);"Easter Day is on";
190 GOSUB 230
200 easter%=easter%+1:PRINT SPC(8);"Bank Holiday Monday is on";
210 GOSUB 230
220 END
230 IF easter%<32 THEN PRINT " March";easter% ELSE PRINT " April";(easter%-31)
240 RETURN

```

# MOVING WRITING

by Ruth Taylor

Have you ever yearned to write something that was really moving? Well here's the easy way to do it: for one thing this listing must surely be short enough for anyone to attempt, and for another it really is fun to see words dancing across the page. They actually leap from the side of the screen and dash across until they reach the centre where they know exactly where to stop. Fantastic!

You put your own text starting on line 90 making sure that you still finish with a '++' line. You can even change the position on the page by changing the variable 'row' in line 10.

Use this in your own program and no-one will be able to ignore your prompts.

```

10 move.any$ = CHR$(27) + "Y":row=12:col=0
20 PRINT CHR$(27)+"H"+CHR$(27)+"E"
30 READ a$:IF a$ = "++" THEN END
40 a$=STRING$((85-LEN(a$))/2," ") + a$
50 FOR i=LEN(a$) TO 1 STEP -1
60 PRINT move.any$;CHR$(32+row);CHR$(32+col);MID$(a$,
70 NEXT i
80 row=row+2:GOTO 30
90 DATA This is a simple program
100 DATA to enable
110 DATA text to move across
120 DATA the screen
130 DATA ++

```

# RSC Ltd



(0923) 43301  
(24 hours)  
(0923) 41921

ALL PRICES INCLUDE VAT & POSTAGE  
Export, Government & Educational Orders Welcome  
All enquiries & payments to  
**RSC Ltd, 75 Queens Road, Watford WD1 2QN**  
Telex 265871 MON REF G. REF CJJ128  
Tel: (0923) 43301 - 41921  
Callers Welcome

## PCW HARDWARE

ALL PRICES INCLUDE VAT & P&P

Amstrad PCW 8256	£430.00
Amstrad PCW 8512	£545.00
(All PCW's come with 5 free blank disks)	
Amstrad RS232/Cent. Interface	£56.50
Amstrad FD/2 Second drive	£144.50
8256 Memory Upgrade 8512	£27.50

## RSC SPECIAL OFFER

FD2 + MEMORY UPGRADE £167

RSC PCW Printer Extension £12.50  
(pack includes power extension)

## COPY HOLDER

What every work station ought to have. No more looking down - or finding important drafts. Takes very small amount of space and can be positioned at almost any angle.

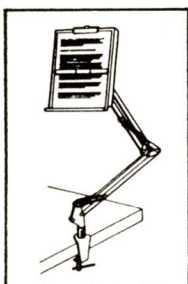

TREAT YOURSELF  
£19.50

## PCW SOFTWARE

### DATABASES

Camsoft Cambase	£39.00
Caxton Cardbox	£45.00
Caxton Condor1	£79.50
Camsoft Delta 1.25	£79.50
Sage Retrieve	£52.50
Sage Magic Filer	£52.50
Amsoftt Microword/Microfile	£39.95

\* Ashton Tate - dBase II £88.50

Datastore (Digita)	£32.50
Supertype (Digita)	£19.95
Database Manager (At Last)	£23.50

### WORD PROCESSING

Micro Pro Pocket Wordstar	£36.50
Micro Pro Pocket Wordstar Deluxe	£62.50
Tasman Tasword 8000	£19.50
Tasman Tasprint 8000	£12.50
Tasman Taspell 8000	£14.50
* All three Tasman programs *	£42.50
Newstar Neword II	£59.50
Arnor Ltd Protexit	£64.50
Arnor Ltd Prospell	£23.50

Fleet Street Editor Plus £64.50

### SPREADSHEETS

ALL PRICES INCLUDE VAT & P&P

Amsoft Supercalc 2	£39.95
Newstar Cracker II	£41.50
Multiplan	£57.50
Scratchpad Plus	£48.50

## K.D. PRINTER STAND

£34.95

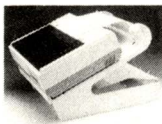

80 column stand  
Paper feeds from underneath and the dial adjustable paper feed plate, guides the paper onto the collection rack —  
Sturdy steel and plastic

## ACCOUNTS

Map Integrated	£115.00
Connect Money Manager	£23.50
Sage Popular	£75.00
Sage Popular Plus	£114.00
Sage Combo Pack	£114.00
Sage Super Combo	£179.00
Sage Payroll	£54.50
Camsoft Sales	£43.95
Camsoft Purchase	£43.95
Camsoft Nominal	£43.95
Camsoft Invoicing	£43.95
Camsoft Payroll	£43.95
Camsoft Accounts SIS	£82.50
Camsoft Accounts SPN	£82.50
Camsoft Accounts SISPN	£112.50

## PRINTER PAPER

2000 sheets 11" x 9.5" (fanfold)	£16.50
EXTRACT A4 size - 2000 sheets	£24.50
1000 Adhesive labels	£6.95
2000 Adhesive labels (2 across)	£9.95

## GRAPHICS

Dr Draw	£38.95
Dr Graph	£38.95
(Both programs together)	£75.00
Electric Studio Lightpen	£64.50
Electric Studio Mouse Set	£114.50
Electric Studio	
Newsdesk International	£42.50
Grafpad 3	£137.50
Electric Studio Video Digitiser	£92.50
AMX Mouse package	£72.50

## COMMUNICATIONS

Miracle Technology	
Modem WS4000	£189.00
Amstrad V21/V23 Modem	£97.50
(Free subscription to Micronet/Prestel)	
Sage E Mail	£59.95
Sage View Data	£59.95
Sage Combo (E Mail/View Data)	£89.95
Sage Chit Chat	
(E Mail with modem)	£175.00
Sage Chit Chat	
(View data with modem)	£175.00
Sage Chit Chat Combo Pack	£209.00

## PCW GENERAL & UTILITIES

Locomail	£36.50
Locospell	£36.50
Mass Easy Labeller	£32.50
Caxton Brainstorm	£38.50
Caxton Touch 'n' Go	£19.95
Rotate	£23.50
Plan It	£21.50
Companion	£18.50
Locoscript 2	£42.50

## PRINTERS — DOT MATRIX

Amstrad DMP 3000	£189.00
Amstrad DMP 4000 (132 col)	£385.00
Epson LX 86	£245.00
Epson EX800 - 300 cps (80 col)	£499.00
Epson EX 1000 300 cps (132 col)	£599.00
Micro P200 - 200 cps 80 col	£335.00
Micro P201 - 200 cps 132 col	£415.00

### PANASONIC '86 BEST SELLER

Panasonic 1080	
100 cps/NLQ/80col	£175.00

## DAISYWHEEL

JUKI 6100	£285.00
-----------	---------

## PRINTER ACCESSORIES

PCW Printer Cable	£12.50
Epson LX86 Tractor Feed	£23.00
Epson LX86 Sheet Feeder	£63.00
Juki 6100 Sheetfeeder	£269.00
Juki Daisywheels (Different Types)	£14.95

## LOCOPRINT

Allows PCW owners to use Locoscript with any other printer £34.50

## PRINTER RIBBONS

(Minimum order 2)

PCW Printer ribbons (price per one)

QT2	QT5	QT 10 or more
4.95	4.50	4.00

(Other ribbons please phone)

## 3" DISCS IN 10's

CF2 double sided/single density	£28.50
CF2D double sided/double density	£57.50

## PCW DUST COVERS

Very attractive set  
Keep your PCW dust free.  
VDU keyboard & Printer £9.95

## MINI SUPER CLEANER



### TMSCI Mini Vacuum cleaner

Battery operated cleaner that absorbs dust and dirt or can be used as air duster with a simple change of bag and nozzle. Supplied with dust bag, brush, straight and curved nozzles.

£9.95

## DISC BOXES For CF2 Discs



RSC 30 Lockable  
£11.50

RSC 60 Lockable  
£14.95

## LEISURE SOFTWARE

Hitchhikers Guide to the Galaxy	£21.50
Leather Goddesses	£21.50
Suspended	£21.50
Cyrus Chess	£14.00
Bridge Player	£17.50
Colossus 4 Chess	£16.50
Batman	£13.50
Lord of the Rings	£24.50
Tomahawk	£16.50
Scrabble	£17.50
The Pawn	£21.50
Trivial Pursuits	£18.50

# BASIC SETKEYS

by Terry Dwyer

Using the SETKEYS utility in CP/M may not be the most difficult challenge in using the PCW but it must be said that it's not exactly easy either. So why not use this BASIC program and take all the worry out of defining your unused function keys?

The program asks you which of the f-keys – the four keys right of [RETURN] – you want to define. What this means is that commands you use regularly, such as BASIC, SYSTEM, DIR or ERA M:\*.\* can be achieved at one keystroke. All of these can be used with an automatic [RETURN] (it asks you whether you want a [RETURN] at the end). Without the [RETURN] at the end of the command, you can set the keys up to generate commands used regularly in BASIC, for instance RIGHT\$( ) or MID\$( ) to make life easier when you are programming.

```

Ok
run
Insert boot disk. Information will be kept in a file on this disk.
Press a key when ready

To define the function keys, press 1-8 (9 when finished)
1
Type required character or string? BASIC
Do you require a carriage return also? Y/N Y
Key f1 = BASIC + <RETURN>

To define the function keys, press 1-8 (9 when finished)
2
Type required character or string? SYSTEM
Do you require a carriage return also? Y/N Y
Key f2 = SYSTEM + <RETURN>

To define the function keys, press 1-8 (9 when finished)
3
Type required character or string? DIR
Do you require a carriage return also? Y/N Y
Key f3 = DIR + <RETURN>

To define the function keys, press 1-8 (9 when finished)
4
  
```

The ordinary settings that apply whenever you turn the machine on make [f5] halt the screen display and [f7] copy all text to screen and printer. Mr Dwyer suggests you might want to leave them alone, but all the others are up for grabs. When you have defined them all type '9' and the file FN.KEYS is created.

If you have a 'PROFILE.SUB' file already the program modifies it to run the new file. If you don't, it will create a brand new PROFILE.SUB. Make sure you have SUBMIT.COM and SETKEYS.COM on the disc to make it work. It will not work until the next time you boot up, of course, but it will load automatically after that.

The only problem could arise if you are already using SETKEYS for another application. If you are using a large SETKEYS file – in NewWord for example – you may find that trying to define too much with this program can cause problems.

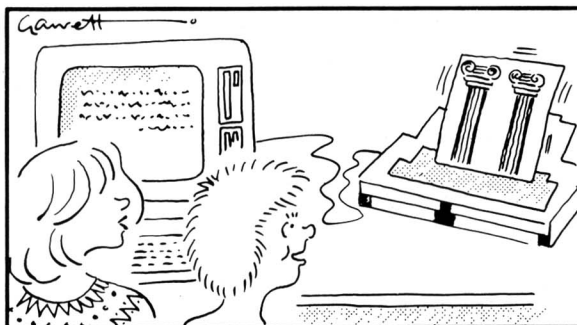

"WELL, IT DOES SAY THAT IT'S SUPPOSED TO PRINT TWO COLUMNS . . . ."

```

10 PRINT "Insert boot disk. Information will be kept in a file on this disk."
20 PRINT "Press a key when ready":a$=INPUT$(1)
30 qt$=CHR$(34):f$="fnkeys":OPEN "0",1,f$
40 PRINT:PRINT "To define the function keys, press 1-8 (9 when finished)"
50 a%=VAL(INPUT$(1)):IF a%<1 THEN PRINT CHR$(7):GOTO 50 ELSE IF a%>8 THEN 130
60 PRINT a%:PRINT #1,"E #8"DEC$(a%,"#") "qt$;
70 INPUT "Type required character or string":a$:PRINT #1,a$;
80 PRINT "Do you require a carriage return also? Y/N ";
90 q$=UPPER$(INPUT$(1)):IF q$<"Y" AND q$<"N" THEN 90
100 PRINT q$:IF q$="Y" THEN PRINT #1,"M"qt$ ELSE PRINT #1,qt$
110 PRINT "Key f"DEC$(a%,"#") = "a$,:IF q$="Y" THEN PRINT " + <RETURN>" ELSE PRINT
120 GOTO 40
130 CLOSE:PRINT:PRINT "Do you have an existing PROFILE.SUB? Y/N ";
140 q$=UPPER$(INKEY$):IF q$<"Y" AND q$<"N" THEN 140
150 PRINT q$:IF q$="N" THEN OPEN "0",1,"profile.sub":PRINT #1,"setkeys "f$:CLOSE:END
160 ELSE OPEN "1",1,"profile.sub":OPEN"0",2,"temp":PRINT #2,"setkeys "f$
170 WHILE NOT EOF(1):LINE INPUT #1,a$:IF a$="setkeys fnkeys" THEN 180 ELSE PRINT #2,a$
180 WEND:CLOSE
190 ERA profile.sub
200 REN profile.sub=temp
  
```

## How to type a listing in

The first thing is to load Mallard BASIC. Turn on your PCW, or reset it by pressing [SHIFT][EXTRA][EXIT], and put a copy of the CP/M master disc into drive A:.

When the A> prompt appears, type BASIC and press [RETURN]. After a few seconds a message about Mallard BASIC will appear on the screen, ending with the prompt 'OK'.

Type in each line of the listing very carefully, starting with the line number and finishing with [RETURN]. Be careful not to mix up capital I with the number 1, capital O with number 0 and colons with semi-colons. During a long listing, it's important to save your work every 15 minutes or so, and you should always save any listing before printing it. To do this, find a work disc with space on it, put it in the drive and type SAVE "PROGRAM" [RETURN]. Of course, you can choose any name of up to eight characters instead of 'PROGRAM'.

When you've finished, type LIST [RETURN] and the whole program will appear on the screen. Check it, and if any lines are wrong, correct them with the line editor. For example, if there's a mistake in line 100, type EDIT 100 [RETURN]. Use the cursor and delete keys to correct the line and press [RETURN] when you've finished. You

can delete a whole line by typing its number and pressing [RETURN].

To run the program, simply type RUN [RETURN] and yes, the program goes wrong.

It's more than likely, no matter how carefully you typed in the listing, that it won't work properly the first time you run it. You may get an error message such as 'Syntax error in 100'. List the program out and check the screen against the original in the magazine.

Don't forget that the line number in the error message isn't necessarily where the error is – it's simply the point at which the PCW gets stuck. You may have to look elsewhere for the error.

When you find an error, either retype the complete line of use the line editor (described earlier) to correct it. Run the program again, and hopefully this time it will work. If it doesn't you have to go through the correction process again. Once the program is running correctly, save it again. To leave BASIC and return to CP/M, type SYSTEM.

Each time you want to run the program, you must load BASIC, type LOAD followed by the name of the file you saved it in, and type RUN once it's loaded.

## Can YOU program?

If so, you could earn hard cash (£10-100) and instant fame by having your programs printed in this magazine. We're interested in SHORT programs of GENERAL INTEREST: utilities, graphics games and the like.

Programs of 1 to 20 lines are particularly likely to be printed (because we can manage several in an issue) – those that are longer have to be really good, so don't get carried away with lots of lines devoted to 'window-dressing' the program. Instructions can be given in accompanying documentation much more efficiently.

To submit a listing you must supply

the following:

1. A printout of the listing.
2. A disc on which it is saved.
3. A stamped, addressed, padded bag for return of your disc.
4. An explanation of what the program does and how to use it.
5. A signed statement confirming that the program is your original work and hasn't been submitted to anyone else.

Send your submission to: *Listings, 8000 Plus, The Old Barn, Somerton, Somerset, TA11 7PY.*

Please allow up to 40 days for return of your disc – the programs will be assessed all in one batch once a month!

# AMSTRAD SYSTEMS

## DISCOUNT WITH SERVICE

	EX VAT	INC VAT
PCW8256	£ 385.00	£ 442.75
PCW8512	£ 480.00	£ 552.00
PC1512 SDMM	£ 435.00	£ 500.25
PC1512 SDCM	£ 585.00	£ 672.75
PC1512 DDDMM	£ 535.00	£ 615.25
PC1512 DDCM	£ 700.00	£ 805.00
PC1512 HD20MM	£ 865.00	£ 994.75
PC1512 HD20CM	£1030.00	£1184.50



## PRINTER SPECIALS

### DOT MATRIX PANASONIC KXP 1081

120/24CPS NLQ EPSON/IBM COMPATIBLE  
FRICTION + TRACTION, HIGH RESOLUTION GRAPHICS  
OUR PRICE £225.00

### DAISYWHEEL

JUKI 6000 12cps FRICTION OUR PRICE £185.00  
JUKI 6100 20cps FRICTION OUR PRICE £360.00  
FREE...PCW or PC1512 CONNECTING LEAD  
WITH EACH PRINTER

## PCW SOFTWARE

SAGE	
Popular Accounts	£76.00
Popular Account Plus	£115.00
Popular Invoicing	£55.00
Popular Payroll	£55.00
Popular Combo Pack	£115.00
Super Combo Pack	£150.00
Data Base	£55.00
Magic Filer	£55.00
Retrieve	£54.00
Chit Chat "Mail"	£55.00
Chit Chat View Data	£55.00
Chit Chat Combo	£76.00
Chit Chat with Modern	£185.00
Combo with Modern	£225.00
DIGITAL RESEARCH	
DR Draw	£45.00
DR Graph	£45.00
Pascal/MT+	£45.00
CBasic Compiler	£45.00
CAXTON SOFTWARE	
Cardbox	£50.00
Brainstorm	£39.00
Scratchpad Plus	£50.00
Touch 'N' Go	£20.00
Smart Key	£39.00
Condor I	£85.00
Time Keeper	£45.00
CAMSOFT ACCOUNTS	
Cambase Database	£45.00
Payroll	£45.00
Stock/Invoice/Sales - Integrated	£85.00
Sales/Purchase/Nominal - Integrated	£85.00
Stock/Invoice/Sales/Purchase/Nominal	£135.00
Above modules stand alone	each £45.00
OTHERS	
Supercalc 2	£40.00
dBase 2	£69.00
Daybook	£47.00
Realtime Audio Tutor	£9.50
Prospell (spelling checker)	£24.00
Dataflow II/Mailflow III (mailmerge locoscript)	£47.00
Calc Star	£45.00
Easy Labeller with labels	£33.00
Pocket Wordstar Deluxe (with Spellstar)	£55.00
Rotate (Print Utility)	£20.00
Tasword 8000	£19.50
Tasprint 8000	£12.50
Taspell 8000	£14.50

## LEISURE FOR YOUR PCW

## BOOKS FOR PCW

Batman	£13.00	Advanced Amstrad Basic (Locom)	£12.95
Cyruess Chess II	£14.00	Amstrad 8256/8512 More Wordprocessing	£9.95
Lord of the Rings	£23.00	Amstrad CP/M Plus	£12.95
Fairlight	£13.00	Amstrad Comms/CPC/PCW Ranges	£8.95
Bridge Player	£18.00	Amstrad Companion (Mallard)	£7.95
Graham Gooch's Cricket	£18.00	Amstrad Word Processing/PCW 8256	£8.95
Tomahawk	£17.00	An Introduction CP/M Plus on Amstrads	£7.95
Leather Goddesses	£23.00	Complete Guide Amstrad 8256/8512	£12.50
Wishbringer	£23.00	Get Smart Amstrad PCW 8256/8512	£7.95
Zork 1	£23.00	Introducing Amstrad CP/A Ass Lang	£9.95
Enchanter	£23.00	Mastering Amstrad PCW 8256/8512	£8.95
Witness	£23.00	Practical Reference Guide/W-pro. Amstrad 8256	£5.95
Ballyhoo	£23.00	Practical Amstrad Word Processing	£7.95
Planetfall	£23.00	Practical Logo on the Amstrad	£6.95
Hitchhikers Guide	£23.00	Program Your PCW! (Mallard)	£8.95
Cutthroats	£23.00	Soft 971-OP Program Guide (Dig Res)	£25.00
Trinity	£29.00	User Guide to Amstrad PCW 8256/8512	£10.95
French Mistress (Tutorial)	£18.00	Using the PCW 8256	£9.95
Spanish Tutor (Tutorial)	£18.00	Word Processing Amstrad 8256	£6.95
German Master (Tutorial)	£18.00	Advanced Amstrad Basic	£12.95
3D Clock Chess	£18.00	Amstrad Communications CPC/PCW	£8.95
Strike Force Harrier	£18.00	Amstrad Companion	£7.95
Scrabble	£17.50	Amstrad PCW8256/8512 More than	£9.95
Hobbit	£23.00	Programming the PCW!	£6.95
Heros of Khan	£14.00	Step by Step Guide to Locoscript	£4.95
Colossus 4 Chess	£17.00	Basic 2 User Guide	£9.95
Trivial Pursuit	£19.00	Locomotive Basic 2 for PCW	£9.95
The Pawn	£22.00	Operating Amstrad CPM 2.2	£9.95
Silicon Dream	£18.00		

## ACCESSORIES/UPGRADES

Clarity Guides Amstrad PCW	£6.95
Program your PCW (Mallard) 2nd Edition	£7.95
Programming the Z80	£19.95
Z80 Reference Guide	£12.95
Z80 Applications	£15.95
Z80 Assembly Lang. Subroutines	£19.95
Z80 Assembly Lang. Programming	£19.95
Copy Holder Thingy (fits to monitor)	£6.00
2000 Sheets Listing Paper (P&P E3)	£14.00
4000 Labels (1 across)	£17.00
8000 Labels (2 across)	£30.00
Disc Storage Box (holds 30)	£12.00
Disc Storage Box (holds 70)	£15.00
Mouse Mat by AMX	£5.00
Electric Studio Lightpen	£64.00
Electric Studio Mouse	£114.00
Electric Studio Digitiser	£92.00
Joystick Controller	£22.50
FD2 Second Disc drive	£149.00
FD2 and Memory Upgrade	£170.00
8256 Memory Upgrade	£25.00
RS232/Centronics Upgrade	£57.00
V21/V23 Amstrad Modern	£95.00
2 PCW Printer Ribbons	£10.00
Cover Set (3 Piece)	£12.00
Printer Lead Extension	£12.00
Blank 3 inch Discs (10)	£30.00
Blank 3 inch Discs DD for 2nd Drive	£50.00
Antiglare Screen	£24.00

MAIL ORDERS TO 22 GUILDFORD ROAD, BAGSHOT, SURREY GU19 5JN

ACCESS/BARCLAYCARD/VISA ORDERS WELCOME  
CREDIT FACILITIES Instant credit up to £1,000, deposit 10% - Visitor only  
PLEASE MAKE CHEQUES/POSTAL ORDERS PAYABLE TO:



P&H ELECTRONICS LIMITED

or quote your Card Number and Expiry Date please

UK CARRIAGE COSTS - SOFTWARE & BOOKS FREE

SYSTEMS, PRINTERS - £7.00, ASSEMBLIES - £2.00

OVERSEAS ORDERS - OVER £15.00 SENT VAT FREE INCLUDING BFPO ORDERS SENT AT UK RATES.

PLEASE MAKE ALL PAYMENTS IN STERLING.

CARRIAGE - BOOKS, SOFTWARE, ASSY. - £3.00 PER ITEM

SYSTEMS - £40.00. DISC DRIVES, PRINTERS - £20.00



## NOW FOR YOUR PCW DESK TOP PUBLISHING

FLEET STREET EDITOR - £60.00  
AMX PAGEMAKER - £43.00  
AMX MOUSE WITH DESK TOP - £70.00

### AMSTRAD MICRO CENTRES TELEPHONE OR VISIT

FAST PHONE SERVICE - 48 HOUR DESPATCH ON ITEMS IN STOCK  
SUPPLIERS TO SCIENTIFIC AND EDUCATIONAL AUTHORITIES  
ALL PRICES INCLUDE VAT EXC. PC/PCW  
PRICES ARE SUBJECT TO CHANGE WITHOUT NOTICE

# The UPGRADE

## SPECIAL OFFER TO PCW 8256 OWNERS

Thought about upgrading to PCW 8512 specification?

Wondered if you could manage to do this yourself?

### NOW YOU CAN FIND OUT.

Send us £1 and we will send you a copy of our INSTALLATION INSTRUCTIONS and our FACTSHEET on upgrading. You may deduct the £1 when you order your upgrade.

The specialist PCW magazine, "8000 Plus" selected our Upgrades as "BEST VALUE D-I-Y MEMORY UPGRADE" and "BEST VALUE 3 INCH SECOND DRIVE"

"Silicon City instructions are clear and concise...you could find it easier than you think".

The simplest, most comprehensive step-by-step instructions available assume no prior knowledge, experience, or skill. We supply tested, TOP QUALITY, fast (150ns) chips which are jig preformed for ease of insertion - NO BENDING REQUIRED - plus a spare 'practice' chip to give you confidence.

Our "Best Value" Upgrade Kit is NOW ONLY **£23.90**

"If you go a stage further and add a second disc drive, you won't need to swap discs at all."

"Fitting the second drive is simple enough...Everything other than the drive is already there in your machine: the cables are ready wired and both LocoScript and CP/M software will recognise it automatically once it's fitted...you'll have to try pretty hard to get it wrong."

Internal PCW 8256 DS/DD Second Disc Drive  
1 Megabyte unformatted (720K formatted) **£135**

Memory Upgrade plus Second Disc Drive **£155**

Supplied with simple, comprehensive fitting instructions. NB You will require CP/M version 1.2, or later to format high density discs. Amstrad will exchange earlier versions free of charge.

TRADE ENQUIRIES WELCOME

Prices INCLUDE VAT and UK post, normally by return.

Send UK Cheques/Money Orders/LA or Government orders to:

**SILICON CITY**

Dept. 8, Mithian, St. Agnes, Cornwall TR5 0QE

Access/Visa orders: Telephone 087 255 2112

# Saxon Computing

*Flexi Collection* for PC 1512 & IBM

*Micro Collection* for PCW8256/8512

Each collection contains

- DATABASE
- WORD PROCESSOR with MAIL-MERGE
- LABELLING PROGRAM for goods or mail labels
- FILE ENCRYPTION software for data security

Plus a FREE SPREADSHEET program

## What The Magazines Say

"Very good general purpose office control package" 8000 Plus  
"Database ... simple to use, fast and reasonably powerful" Popular Computing Weekly

"An impressive combination" Computing With The Amstrad

"Good value" 8000 Plus Good Software Guide

Flexi Collection or Micro Collection just £49.95 inc VAT & postage

Call for details of our disk translation service  
PCW disk data to PC1512 disks in 24 hours

SAXON COMPUTING

11 ARRAN ROAD

LECONFIELD

N. HUMBERSIDE

HU17 7NP

Telephone 0401-50697

VISA



# FREE LOADING

Frank Peters shows how to tap the Public Domain

To get hold of all the PD Software covered in this column, you will need a modem. When you log on to a bulletin board, you then 'download' the program you want - the software you need to do this can also be found in the Public Domain.

Over in the States, Ward Christensen needed a means of passing a file between two computers accurately and error free. From him, 'Xmodem' was born, and all good communications software written since has included this.

There are a couple of programs in the Public Domain currently available to make your life as easy as possible for transferring files by modem. For the PCW there is the grandchild of Christensen's original Xmodem program, '8256UKM7', which is specially written for UK standards. Another is MEX, of which more later.

## Getting into 8256UKM7

8256UKM7 is definitely a good starting point for beginners. It is easy to use and is far more versatile than the PCW's standard MAIL232. You can transfer files error free, unlike CHITCHAT, and it is not as complicated to use as say, COMM+.

Having run up the program from the CP/M prompt you will be presented with a full list of all the commands available to you. It will also tell you information about the way the serial interface has been set up. The default values are TURBO speed (31,250 baud) with each character set to 8 data bits, no parity and one stop bit.

Before logging onto a bulletin board which is using 7 data bits, even parity and one stop bit, you will have to use the OPT (options) command to set up the required configuration. This is very easy to do, just follow the instructions and choose the required options. Type T [RETURN] for terminal mode and you will be presented with a short menu of commands available from terminal mode.

If you want to receive messages into a file at your end then at the main menu enter terminal mode with a filename attached like this....

A>T DUMMY.TXT [RETURN]

This will then display a colon at the start of each line to remind you that you have terminal save mode on. To toggle between saving being on and off press ↑ Y. When you exit back to CP/M or re-enter terminal mode with a second new filename, it will close and save the file for you.

There has been a further addition made in the last few years to the Xmodem system, called 'Batch mode'. This is a beautifully lazy way of exchanging files: after telling the host computer which files you want, it automatically transfers them one after the other and puts them on your disc. Some services do not support this yet, but the Fido group of Bulletin boards certainly do. UKM7 defaults to this mode so it is therefore necessary to enter that you want NON-batch mode at the command prompt when about to start a transfer.

## MEXimum performance

MEX (Modem EXecutive programme) contains all the features given to you in UKM7 but with lots more added to allow you to autodial numbers ad nauseam until they become free (strictly against BT regulations), and the ability to fine tune the program to your exact requirements and save all these changes and phone numbers inside the programme itself with the 'CLONE' command.

How about commonly used pieces of text like your name, IDnumbers, or password? These can all be saved away as 'keystings' sent out for you by pressing [EXIT] then the key you saved it under. To make things even easier, you can store in a file the sequence of commands that would log you onto a system, and read these in automatically.

There is nothing to stop you taking it one step further and in fact writing an ASCII file of commands that will set up MEX how you want it, dial the number for you until free, logon, download all the messages waiting for you and sign off. Because of MEX's complexity, there is no doubting it will take time to learn ALL its possibilities and commands, because of this a very fast and comprehensive help menu is on hand at all times. Need help with the CALL command? Easy, type in HELP CALL.

## In control

Whenever you are told to type ↑ C, or ↑ C, in magazines or manuals, this is a standard way of describing [ALT]-C. First hold [ALT] down, and then at the same time press the C key (or whatever letter it is).

## Where to go

How do you know if any software will be of any use to you? The simple answer is to logon to your nearest Public Domain Software Interest Group (PD SIG) bulletin board and ask. If the system operator (SYSOP) can not help you, there is always someone else that can! These bulletin boards don't require a membership fee, although actually joining the PD SIG is well worth the money with regular newsletters of hints, tips and news of CP/M software.

It has to be admitted that there is some software freely given to the Public Domain that will not work on a

PCW8256, or is just not very robust.

The following computer systems are available for free use by anyone. Don't forget you will need to set up your interface to 8 data bits, no parity and one stop bit - often abbreviated to 8N1. They all have 1200/75 baud, most also will work at 300 baud.

Langford ROS	0462 700893
10pm to 9am only (LocoScript)	
8256UKM7 document available)	
PD SIG	0892 61149
24 hours (The main PD SIG centre)	
Fido Gamlingay	0767 56551
24 hours (A PD SIG Board)	

```

SYNTAX: primaryoption[secondaryoptions? [d:][filename] [ afn]
          PRIMARY OPTIONS:
S      Send binary files, afn list
R      Receive binary files, drive:
T      Terminal mode, Terminal filename optional
DEL    Delete Terminal file
DIR    Directory list, afn optional
CPM    Exit to CP/M
LOC    Log all drives
SET    Set tx/rx baud rates ( currently : TX = 31250, RX = 31250 )
OPT    Set tx/rx options ( currently : PARITY:none, BITS:8, STOP BITS:1 )
DRV    Change default drive ( currently : A: )
EXP    Expert, toggle menus on/off
M      Menu display

          SECONDARY OPTIONS: (for primary options S and R)
N      Non batch mode, send or receive file
Q      Quiet mode, remote system send/receive
CP/M  Monitor data sent, received or view file
+      Go to terminal mode after file transfers
R ==>?

+?    Transfer (Send) ASCII file without checks
+*    Abort transfer, initiated above
+*    Computer mode, toggle echo on/off
+*    Send following character literally
+*    Set a command menu
+*    Display terminal menu
6
    
```

▲ The main menu of 8256UKM7

## Xmodem Xplained

The Xmodem protocol is now universally accepted as a reliable means of file transfer. The idea is based on a means of breaking up the file in to smaller segments which are sent one after the other along with an error check count at the end of each block. The receiving end stores the block in a temporary buffer waiting for the check count. If it all checks out OK and there

were no errors detected the receiver sends back an 'acknowledged' signal to say everything was OK and to carry on with the next block. If it detected an error (because of line noise perhaps) it will send the 'not-acknowledged' signal telling it to try again. This continues until the file is either safely transferred across or deliberately aborted by either end.

AMSTRAD  
PCW / PC



The Minerva  
"LEARNER  
FRIENDLY"  
Range

The easy to use computer software written for People not Programmers, bringing simplicity of operation to the Amstrad PCW and PC.

**No.1 FIRST BASE**

A simple to use database containing all the features likely to be needed by the new computer user. Easy record design, finds any record in 2 seconds, search for groups, automatic sorting, mail-merge with any wordprocessor with ASCII based output including LocoScript, reports, totals. **Only £29.95**

**No.2 LERNLOCO**

If you have just purchased your Amstrad or you are finding the manual too complex, then this tutorial is just what you need. A LocoScript tutorial which teaches every function FROM WITHIN LocoSCRIPT. You will become so confident that you even produce your own personalised manual! **Only £16.95**

**No.3 TYPERITE**

This touch typing course is accessible from within LocoScript and teaches the correct method for the skill of fast and efficient typing. **Only £19.95**

**No.4 FIRST CALC**

Contains probably every facility you are likely to need in a spreadsheet yet written with simplicity of operation in mind. **Only £29.95**

**RESIDENTIAL COURSES**

The courses run from Friday evening to Sunday afternoon with all meals included. A maximum of six places are available on each course.

Software for other computers also available.

AMSTRAD CPC 464 664 6128

**RANDOM ACCESS DATABASE**

Powerful and versatile. Finds records in seconds. Multiple print formats - mix 40 & 80 chr. text. Extensive calculations. Searches & Sorts. 40 fields per record. 6000 records on 6128. **£39.95**

**INSTANT ACCESS**

Programming utilities which include Random Access, Sector editing, Error handling, BASIC enhancements and also an Evaluator. **£29.95**



**MINERVA SYSTEMS,**  
69 SIDWELL STREET, EXETER,  
DEVON, EX4 6PH. Tel: 0392 37756

**DESKTOP**

**PRICE BREAKTHROUGH!**

- 10 Amsoft 3" disks ..... only £25.00!
- 5 Amsoft 3" disks ..... only £13.00!
- 3" Storage Box(10) ..... £4.95!
- PCW Ribbon ..... £4.75!

Professional Quality  
Dustcover Set ..... £19.84!

Cables X Paper X Software

**DETAILS OF FREE DISKS**

Call Trish  
on  
**0388  
767244**  
prices include  
VAT  
add £1 P&P



Send for details or order from:

**DESKTOP, DEPT. 8000, 11 WEST ST, HETT  
CO DURHAM 0388 767244/813035 (24 hrs)**

**SAME DAY  
DESPATCH**

"Quite the best and most flexible personal accounts system I've seen - doubles as an inexpensive business system" Computing with the Amstrad September 1985

"Money Manager is good enough to make most programs of this type give up in shame" Popular Computing Weekly 17-23 April 1986

**Unbeatable value**

**CPC464**

**MONEY MANAGER**

**Unrivalled features**

**CPC664**

SAVE £5 on RRP of £29.95 when you order direct from Connect Systems

**PCW8256**

**CPC6128**

**ONLY £24.95** Incl. VAT, p&p

**PCW8512**

**Financial management software for personal and/or small business use.**

Money Manager is an easy-to-use system for recording all financial transactions, and for analysing them in a number of very powerful ways in order to facilitate sound financial management. It is ideal for controlling the finances of a small business, or for users wishing to control their personal finances in a business-like way. Use it to check bank statements, keep track of expenditure, monitor cash flow, make budgeting forecasts, prepare business financial statements, pacify your bank manager, convince the tax and VAT inspectors, avoid nasty surprises, etc. etc.!

12 months of entries are kept in a file stored on your disc. At any time, you may load a file into the computer memory, add to or edit the entries, analyse them, print statements, and then save the updated file for later use. Entries may be historic (for record keeping) or forecast (for budgeting). You may have any number of separate files, and make copies of files for archive purposes. You may advance the period covered by a file month by month.

Up to 100 separate transactions may be entered per month. Each entry consists of:

- The day of the month, e.g. 23rd of June.
- An account number, one of up to 9 defined by you to suit your circumstances e.g. 1=Barclays, 2=Visa, 3=Halifax etc.
- Reference, e.g. ABC123 for a cheque number or invoice reference.
- A class code, one of up to 50 defined by you to suit your circumstances e.g. h0=Household expenses, h1=Mortgage, h2=Rates or p0=Production, p1=Raw materials, p2=Assembly, p3=Packing, etc.
- A description so that you can see what each transaction was for, e.g. "New gearbox" or "Box of 10 discs".
- An optional single character mark which you may include for further classification, e.g. b=business, p=private, etc.
- The amount of the transaction, which may be plus or minus.
- A marker to indicate whether the entry is exempt, zero rated or taxable for VAT, or alternatively the actual VAT paid.

You may select categories according to account, class and mark (e.g. all entries, or all motoring expenses for business using a credit card, etc.) and produce reports on the screen or printer as follows:

- Full detailed statements, showing each transaction for any month or for the whole year.
- Detailed monthly VAT statement showing input and output amounts excluding VAT, the actual VAT and the total amount, plus totals and net VAT due.
- Tables showing the totals in each class for each month of the year.
- Tables showing the totals in each class for each account.
- Tables showing monthly maximum, minimum, average balances, turnover, cashflow etc.
- Bar graphs of any category month by month.
- Pie charts of annual totals for various categories (CPC version only).

**Plus: standing orders - entries optionally sorted into date order - item search facility. Comprehensive manual and full set of practice data included.**

**Full telephone support.**

Send cheque or credit card number or phone for immediate despatch.



**Connect Systems**

**3 Flanchford Road, London W12 9ND 01-743 9792 8am-10pm 7 days a week**



# TIP-OFFS

Psst! Wanna know a secret? Then you've come to the right pages.

Tailor made for all music taping pirates is this month's 30-smackeroo winning tip from Simon Hall in Dorking – a simple but effective LocoScript document to print out all your cassette inlays for you. If that doesn't tempt you, how about telling the time in BASIC? Colour coding your discs? The list is endless.

Your magazine needs you to send in even more bright ideas. If the promise of national fame and glory isn't enough for you, will the promise of £30 twist your arm? That's what we pay for the best tips each month. Write to *TipOffs*, 8000 Plus, The Old Barn, Somerton, Somerset TA11 7PY.

## Logo secrets

A few hints about the mysterious world of Logo. Using the [f1] key during a graphics routine will cause it to pause. You can then move the turtle and carry out another procedure if you want. Then type c o to return to the original procedure. It will continue from the turtle's new position.

Using the [f5] after a graphics routine will return the screen back to the split screen in use before the routine.

If the full graphics screen is in use when you are printing text with graphics you have to use f s at the end of the command:

```
ts setcursor [n m] pr [ ...
(where n and m are the
coordinates of the place on the
screen where you want the text).
```

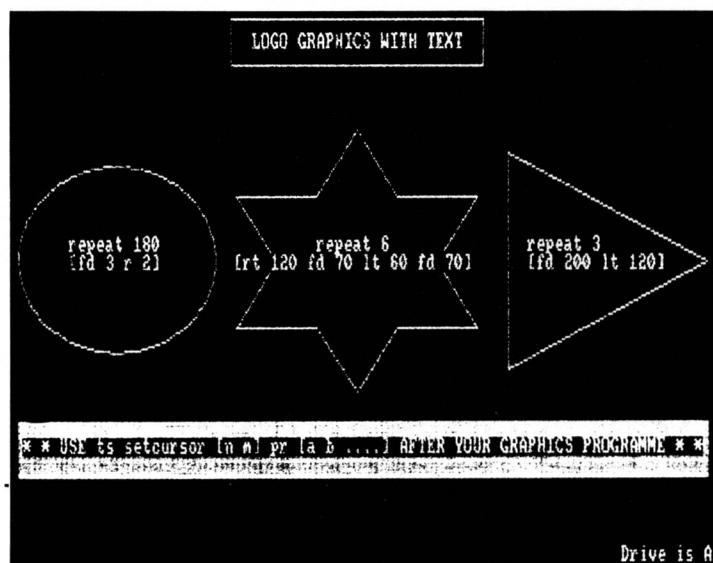

## What type?

Here is a neat way to ring the changes in typefaces using the escape combination ESC ! n (with a 6 bit number n). It uses a D E F F N statement at the beginning of your program

```
DEF FNfont$(b%,c%,d%,
e%,f%)=CHR$(27)+"!"+"
CHR$(f% OR 4*c% OR 8*b%
OR 16*d% OR 32*e%)
```

In this  
b% stands for BOLD  
c% stands for CONDENSED  
d% stands for DOUBLE (strike)  
e% stands for ENLARGED  
(double width)  
f% stands for FONT

Easy to remember. A zero in the function call turns each parameter off and a one turns each parameter on. The only parameter not obvious is the Font. Here a zero gives Pica (10 pitch) and a one gives Elite (12 pitch).

From this you can achieve the full variety of combinations.  
PRINT FNfont\$(0,1,0,0,0);  
17 pitch (Condensed Pica)  
PRINT FNfont\$(0,0,0,0,1);  
12 pitch (Normal Elite)  
PRINT FNfont\$(0,0,0,0,0);  
10 pitch (Normal Pica)  
PRINT FNfont\$(0,1,0,1,0);  
17 double pitch (Condensed

Enlarged Pica)  
PRINT FNfont\$(0,0,0,1,1);  
12 double pitch (Enlarged Elite)  
PRINT FNfont\$(0,0,0,1,0);  
10 double pitch (Enlarged Pica)

There are one or two problems. For instance when using Elite (f%=1), Condensed (c%=1) has no effect. And for some reason using Bolding (b%=1) and Elite (f%=1) does not produce Bold Elite as expected but Enlarged Pica.

There seems to be no way to reproduce 15 pitch?", but why does anyone want to use 15 pitch?  
R.D.Post, Southery, Norfolk

## Underlining in NewWord

One annoying drawback with using NewWord is that you cannot reproduce continuous underlining on paper. This can be rectified (as long as your printer can do continuous underlining, as the PCW standard one can) by 'installing' the program.

Copy the program file NW.COM into the memory drive. Put the NewWord disc in the current disc drive and type NWINSTALL. You are now given the option of changing the default settings in the program (see the 'Nuts & Bolts' section of the NewWord manual.

With option H, you can change the default setting from word underlining to continuous underlining, which enables this function to work without having to enter the dot command . u l in every document.

Go to 'Patch Menu 3', select the Continuous Underlining option, and type F F at the cursor position – this stands for 'yes'. Now exit from NWINSTALL, and copy the modified NW.COM back from the M drive onto your NewWord work disc.

Julie Capas, Northwood

## What's in a name?

If you have made up your LocoScript work disc by copying the master disc and deleting all the files you don't want, the groups will still be named 'LETTERS', 'CONT' and so on.

You can change these names with the [f5] key, but since you can't put lower case letters or spaces into group names, you can never make them revert to 'group 0' if you would rather have unnamed groups.

The name for a group is stored by LocoScript in the group as a file of zero length called 'groupname.GRP'. LocoScript looks for a file ending .GRP and calls the group after it. What you have to do is to delete this file, and then the group will be called 'group 0', or whatever number it is.

Although the .GRP file is not shown on the Disc Manager Screen, it can be erased normally. If the group you are currently in is called 'LETTERS', press the [f6] key, specify the name LETTERS.GRP as the file to delete, and you will have un-named the group.  
Kai Arste, Llantwit Major

# Advantage

## The Independent Computer User Group

ADVANTAGE (EP7) 33 MALYNS CLOSE CHINNOR OXFORDSHIRE OX9 4EW Tel 0844 52075

AUTHORISED PC-SIG DEALER

ORDERING — Prices include VAT and UK postage. VISA and ACCESS accepted by post or telephone. Send a stamped, addressed envelope for our latest catalogue

PLEASE STATE WHICH COMPUTER YOU ARE USING

PC OWNERS — SEND JUST £2 FOR OUR NEW CATALOGUE ON-A-DISC WHICH ALSO INCLUDES SAMPLE GAMES AND UTILITIES.



NEW

### PCW & CPC SOFTWARE

EACH DISC: £8.95 (Advantage Members £6.95) Overseas please add £1 per disc. The six discs below contain Public Domain software plus Advantage user notes.

**COMPLEAT UTILITIES** — Selective file copy erase, hide, rename and print, Sector Editor, Z80 Assembler/Disassembler, Z80 Debugger, Erased File Find and Recovery (CP/M 2.2), Sorted Directory, File Scanner, Splitter, String Finder, Bad Sector Eliminator, Typewriter Emulator

**GAMES COMPENDIUM** — Chess, Colossal Cave Adventure, Othello, Mastermind, Awari, Life, Golf, Polish Pong, Maze, Biorhythms, Word Search Puzzle Maker, Calendar Generator, Noughts & Crosses, Banner Printers

**APPLICATIONS** — Inventory/Database, Library Utilities, Word Count, Alphabetic Sort, Simple Spelling Checker, Easy to edit Starter Dictionary, Disc Catalogger, File Squeeze/Unsqueeze (saves up to 40% disc space), Password Protection

**COMMUNICATIONS** — UK Modem7, Kermit, MEX, BINARY-HEX Converter and other utilities

**AMUSEMENTS & DIVERSIONS** — 25 games & 8 utilities written in unprotected MALLARD BASIC, including Star Trek, Merchant, Hangman, Nim, Baseball, American Football, Calculator, Home budget and Label Printer

**SMALL C COMPILER** — produces machine code programs and includes 25k of documentation

### PC SOFTWARE

EACH DISC: £9.95 (Advantage Members £7.95) Overseas please add £1 per disc

We have an extensive library of over 600 PC-SIG public domain and user-supported discs. Here are some of the favourites:

**PC-WRITE**—Multi-function Word Processor 60K file size, 100 page on-disc manual  
**PC-FILE III**—Fully definable Database 32, 767 records, 100 page on-disc manual

**PC-CALC**—Spreadsheet similar to 123 (64 column x 256 row), 30 page on-disc manual

**PC-TUTOR**—Course in computers and DOS

**CASH-TRAC**—Household budget organiser

**PRO-COMM**—Comprehensive communications

**PC DESKTEAM**—More features than Desk Mate

**ULTRA UTILITIES**—Powerful Disc Doctor with disc mapper, unerase, sector editor

**BEST UTILITIES** Selective delete and copy, print spooler, file browse, super TYPE

**BEST GAMES**—Two classics: Space Invaders & Pacman plus Life, Bugs, Castle (adventure)

**ASSORTED GAMES**—Pinball, Catch The Baby, Frogger, Multi-maze, War Game

**ARCADE GAMES**—3-Demon, Donkey Kong, Golf, Fortune, Breakout, Pango, Pitfall, Pyramid

**PC-CHESS**—Full feature, on-screen board

**OTHELLO**—Reversi game with graphics

**COLOSSAL CAVE ADVENTURE**—Extensive

**STAR TREK**—Large graphics version

**TRIVIA QUIZ**—A two disc set £15.95

**MONOPOLY**—The board game on computer

**CAVE QUEST**—Dungeons & Dragons game

**Q-BERT**—fast square-jumping arcade game

**HANGMAN**—Well presented graphics version

**FUNNELS & BUCKETS**—A fun learning maths game for over 7's

### MIX C COMPILER

—Full Kernighan-Ritchie implementation  
—Fast linker to build an executable program from separately compiled files

—Supports all data types, floats, bit fields, doubles, structures & unions  
—Unix C compatible

—Extensive library of 175 functions  
—Optimisation tools for speed & space

—450 page manual describing compiler operation, C programming and tutorial

—UK technical support from Advantage

"Outstanding value for money" — CWA 2/87. Available for CP/M+ and MSDOS. Second drive or RAM disc is recommended for CPC owners.

£38.95 Overseas please add £5

### MIX C TRACE

A powerful aid to fast program debugging with four-window monitoring and animated trace which highlights each statement as it executes. Single step & continuous

functions with dynamic monitoring of source, output, variables, symbols and memory. Unlimited breakpoints.

Comprehensive manual, MSDOS only £38.95 Overseas please add £5

**MIX SPLIT SCREEN EDITOR** £29.95 Overseas add £3. **MIX ASSEMBLER UTILITY** £10.95 Overseas add £1

Buy any 2 MIX packages — DEDUCT 10% Any 3 — DEDUCT 15% ALL 4 — DEDUCT 20% Advantage Members may also deduct £2 per item

### BORLAND TURBO PASCAL

The fastest Pascal compiler with programming environment, editor, error detection, window procedures, sound, colour and graphics.

"Runs like magic" — PC Magazine  
Amstrad CP/M Version: £65.95 Overseas add £3 PC MSDOS Version £78.95 (Members deduct £2)

### NEVADA & UTAH COBOL

Features runtime error messages, random access and sequential files and integration of assembly language using DR MAC/CP/M or MSDOS

£38.95 (Members £36.95) Overseas add £3

### NEVADA & UTAH FORTRAN

Random I/O file, assembly language support, function library + real time error reports, CP/M or MSDOS

"Outstanding Value" — CWA 11/86 £38.95 (Members £36.95) Overseas add £3

### FULL SCREEN TEXT EDITOR

Suitable for generating compiler source code — CP/M and MSDOS versions available.

£10.95 (Members £8.95) Overseas add £1

### INDEPENDENT USER GROUP

Choose either Group-8 (CPC & PCW) or Group-16 (PC1512) for monthly newsletter, user support and software discounts.

Annual membership: £10.95 (UK) £13.95 (Europe) £16.95 (Rest of World)

## COMPUTER GRAPHICS

£29.95

... provides a very fast and efficient way of accessing a multitude of functions and drawing routines." *'Amfix! Jan. '86*

This extremely versatile and easy to use program allows you to draw lines, circles, ellipses, arcs, polygons on your PCW. Regular shapes can be recalled from memory or erased from the screen with one key stroke. Sets of symbols can be designed for use in your drawings. These can be positioned with pixel accuracy as can text inputs which can be selected from various fonts. Drawing in one and two point perspective is also accommodated. There are fill and hatch facilities and the user is informed of program operation by a constantly updated readout at the top of the screen.

## DRAUGHTSMAN PCW

Send S.A.E. for info or £29.95 to E.G. COMPUTER GRAPHICS, Orange House, Orange St. Uppingham, Leics LE15 9SQ

... an extremely good graphics aid. ... the programme is easy to use, the manual is easy to follow, and the presentation is professional." *'Computing with the Amstrad Nov '85*

Reviews on CPC version

# STOCKMARKET

## THINKING OF INVESTING? ALREADY AN INVESTOR?

STOCKMARKET enables you to record details of purchases, sales and dividends of shares, unit trusts etc. Current share prices can be entered very easily at any time for an automatic folio revaluation. Values of share prices, indexes etc can be recorded, listed and plotted along with moving averages. Practise buying and selling shares. See if your intuition is right.

### PRICES

- \* Store values of share prices, indexes, exchange rates etc.
- \* Up to 260 prices per share (eg. weekly prices for 5 years).
- \* Tabulate prices.
- \* Plot prices and moving averages with log or linear scales.
- \* Actual prices supplied as demonstration data (inc FT 30, British Telecom).
- \* Use curves to select best buying and selling opportunities.

### ACCOUNTS

- \* Record full details of your portfolios of stocks, shares, unit trusts etc.
- \* Practise buying and selling techniques and accurately record your progress.
- \* Up to fifty shares per folio. Store many folios on one disc.
- \* Buy and sell shares with automatic calculation of dealing costs.
- \* User definable dealing costs.
- \* Record dividend yields and price earnings ratios.
- \* Update prices and automatically update yields, P/E ratios and recalculate individual share and total folio value.
- \* Record dividend payments, total dealing costs and keep cash accounts.
- \* Tabulate present folios, past transactions, dividends and cash accounts.
- \* Demonstration data supplied. Comprehensive forty page manual.



CPC 464 (disc)/664/6128

PC 1512 PCW 8256/8512

£49.95 Price: £29.95 (inc. p&p)

**MERIDIAN**  
software



38 Balcaskie Road,  
London, SE9 1HQ.

Tel: 01-850 7057

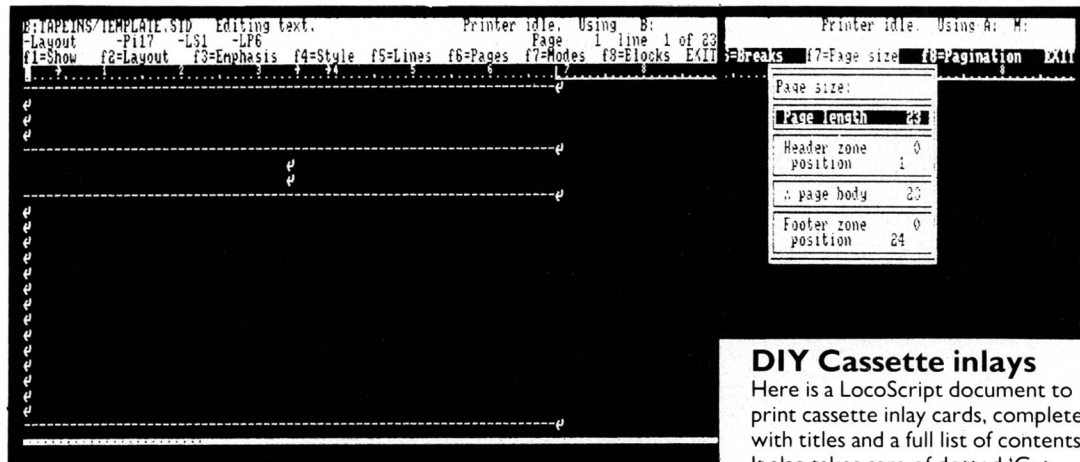

BIG COUNTRY—"The Seer"		TALK TALK—"The Colour Of Spring"	
1, "Look Away"	1, "Happiness Is Easy"	1, "Happiness Is Easy"	1, "Happiness Is Easy"
2, "The Seer"	2, "I Don't Believe In You"	2, "I Don't Believe In You"	2, "I Don't Believe In You"
3, "The Teacher"	3, "Life's What You Make It"	3, "Life's What You Make It"	3, "Life's What You Make It"
4, "I Walk The Hill"	4, "April 5 <sup>th</sup> "	4, "April 5 <sup>th</sup> "	4, "April 5 <sup>th</sup> "
5, "Eiledon"	5, "Living In Another World"	5, "Living In Another World"	5, "Living In Another World"
6, "One Great Thing"	6, "Give It Up"	6, "Give It Up"	6, "Give It Up"
7, "Hold The Heart"	7, "Chameleon Day"	7, "Chameleon Day"	7, "Chameleon Day"
8, "Remembrance Day"	8, "Time It's Time"	8, "Time It's Time"	8, "Time It's Time"
9, "The Red Fox"			
10, "The Sailor"			

▲ The LocoScript template for inputting cassette inlays, and a sample printout.

## Auto debugging

If you type in BASIC listings printed in magazines, you have undoubtedly discovered the pleasures of poring over the magazine page, painstakingly comparing it to what is on the screen, to work out why your program is doing its impression of a Dodo.

If, in BASIC, once your program is typed in you say

AUTO line number

then your program is listed one line at a time as you press [RETURN], starting with the line number you specified (or line 10 if you didn't give a number at all). Once you get to a line with a mistake on it, you can use the cursor keys to edit the line, [RETURN] to confirm the edits, and [STOP] to leave the AUTO mode.

Ian R McDougall, Bradford  
Allan E Fox, London SE23

## Cad and a Bounder

If you have the game Bounder by Gremlin Graphics, you may have noticed that on the introduction screen there is a hint of a 'cheat mode' available.

At the introduction screen, do *not* press space to start the game, but instead press all the following keys at the same time: Q, W, E, R, T, Y, A, S, D, F, G, H, Z, X, C, V, B, N. It is easier to place a matchbox or discbox on the middle-left side of the keyboard and push down — be careful not to press the space bar.

The game will now start and you will never lose your balls when you really should. This means you can get much further in the game and explore the higher levels. If you thought the beginning graphics were good then look at the later-level ones!

Y. Unterman, Cheadle

## DIY Cassette inlays

Here is a LocoScript document to print cassette inlay cards, complete with titles and a full list of contents. It also takes care of dotted 'Cut Here' lines.

Set up a special group for your tape inlays, called TAPEINS or something. Set up a TEMPLATE.STD in that group, and enter the following information:

Pitch: 17 )  
Left Margin: 0 )  
Tabs: 5 ) set in Layout  
35 ) menu  
39 )  
Right Margin: 69 )

Page Length: 23 )  
Header Zone: 0 )  
Header Position: 1 ) set in Page  
Size Footer Zone: 0 ) menu  
Footer Position: 24 )

On the main editing screen:

Line 1: 69 minus signs (one full line)  
Line 5: 69 minus signs  
Line 6:  Pitch  Bold  Italic  
 Centre  
Line 7:  Centre  
Line 8:  Pitch  Bold  Italic, 69 minus signs  
Line 23: 69 minus signs

All the other lines are normal [RETURN]s. When entering the data, use the [f1] menu to show just the 'effectors' on the screen, and use [EOL] instead of [RETURN] to move from one line to the next.

Simon Hall, Dorking

## Coded discs

The trouble with discs is that they all look much the same. But there is a quick means of identification — colour code the spines with marker pens. Master discs can be coded yellow, security copies orange, and day copies left uncoloured.

You can be much more sophisticated with your colour schemes if the circumstances warrant: day copies of account/database/spreadsheet program and data discs can all have several colours, as long as you can find enough colours to go round!  
G.M. Edwards, Dymock  
Christopher Whitmey, Fownhope

## Making a hash of £s

Because computers are largely American-influenced, the standard £ sign can be tricky to print out. Generally speaking, you can print out either £, or #, but not both.

If you print out a BASIC program, all the # signs on the screen will print out as £ on the paper. The way to avoid this is by giving BASIC the command LPRINT CHR\$(27)"R"CHR\$(0). This sets the printer to the American character set rather than UK. You can change back to the default version by doing a printer reset (with the [PTR] key).

You can get the reverse problem in some programs, where you can print out # signs but not £ signs. To get round this, you must again send special codes to the printer.

In SuperCalc2, when you are printing out you will go through a sequence like /Output,Display,All, then the choices are P for print or S for setup. Choose S, and then type [EXIT] R 3 (press [RETURN]). The last menu is returned, and you can now press P for print. This has set up the UK character set, and you should now see £s not #s on the screen.

D. Hill, Romsey  
S.T. Pepper, Derby

## Telling the time

The PCW has a clock built into it which gives the time to the nearest second. This can be set and read from within BASIC, allowing you to write programs timing things.

The clock is held in three bytes of memory: the hours in 64502, minutes in 64503 and seconds 64504. Using the PEEK and POKE commands you can then read and set the time.

The numbers in these memory cells need decoding to give the true hours, minutes and seconds. For example, to find out the number of seconds you are into the minute:

X=PEEK(64504)

SECONDS=X-INT(X/16)\*6

The same formula works for the hours and minutes figures too, with 65404 changed to 64502 or 64503 respectively.

You can zero the clock by POKEing all three locations with zero. Alternatively you can apply a little maths and invert the above formula to work out what values you need to POKE into the memory to set up the time you want.

CP/M's DATE command will set up the day and time for you, outside BASIC.

## LocoScript Diary/Calculator

If you are a LocoScript user, you may envy the CP/M lot their Companions and Write Hand Men. These are utility programs which let you, at the touch of a button, jot down notes, call up a calculator, or browse through an address book, no matter what program you are running.

LocoScript, not running from CP/M, can't work with these programs. Instead, here are a few suggestions for your very own 'Stationmaster' (get it? LocoScript? Stationmaster? Oh, forget it).

**Diary/Memo Pad:** Set up your diary as an ordinary file in any group of your start-of-day disc. Laid out in preset sections, in any format you find suitable, this serves as a daily updatable memo list with separate sections for urgent phone calls, meeting times and miscellaneous notes like *Feed the piranha*.

Call this diary file **TEMPLATE.STD** – obviously it can't be in the same group as another **TEMPLATE.STD**. When LocoScript starts up, it automatically copies all the **TEMPLATE.STDs** it can find into their corresponding groups on the M drive. This means that you can change disc after disc and your diary will always be available in the M drive for you to update and inspect (as long as you can remember its group number).

## Drawing the line

A very useful phrase to have in your **PHRASES.STD** file is

`ULRjustUL`

Calling it phrase L is appropriate.

It is particularly valuable if you often type anything which needs written responses: questionnaires, forms, pupil worksheets etc. A small poll has revealed that many people prefer to write answers on continuous lines rather than dotted lines.

The effect of the code is two-

**Address book/Phone list:** This comprises two discs, offering a maximum of over 200 files (more discs needed if you are a very popular person), each file holding a pre-entered address on page 1, followed by a telephone number on page 2.

If you name each file with the contact person's surname, then LocoScript will list out all the contacts in alphabetical order on the screen. It is the work of moments to insert it into a letter, or print out the address on an envelope or label – only make sure the template is correctly set up for the envelope, and that you abandon printing before page 2 (the phone number) is printed.

**Scratchpad:** A particularly neat one, this. LocoScript has an 'Inspect document' command, which with a little cunning can be used as a mini-jotter.

LocoScript-using readers will know that 'Inspect' is like one of those tags you tie on your suitcase. It consists of a few lines of text that you can set up and edit to provide a brief description of any file, for random inspection and memory jogging from the disc manager screen. If the name of the file and your memory is good enough to tell you what a file contains, then this Identify text is ready and waiting for more interesting purposes...

Imagine you are in the middle of a long editing session and the phone rings. Damn! You can't

reach that biro (or you've given them up as bad for your health). You badly need to jot down that urgent message, what do you do?

Press 'f7 Modes' – 'Edit Identify Text' – [ENTER], and there's your three lines of available jotter space. When you've finished, press

[ENTER] again. At the end of the day, when you've exited normally from your file, your jotting has been automatically retained for inspection from the disc manager with the [f2] key. You can get a hard copy with [EXTRA]+[PTR].  
*Steve Gough, London W10*

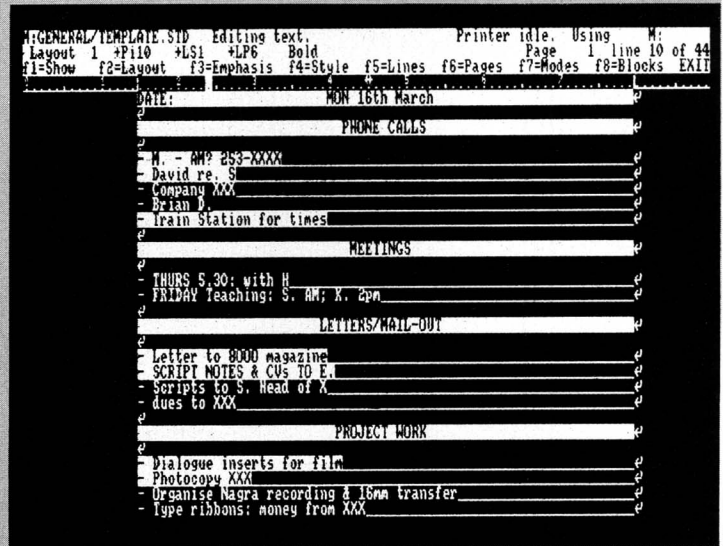

▲ Your diary file, always available in the M drive

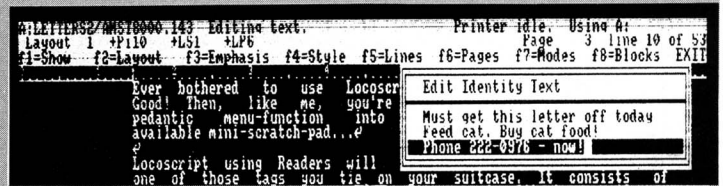

▲ The Identify Text used as a jotter, first being written inside the document, and later being read from the Disc Management screen ▼

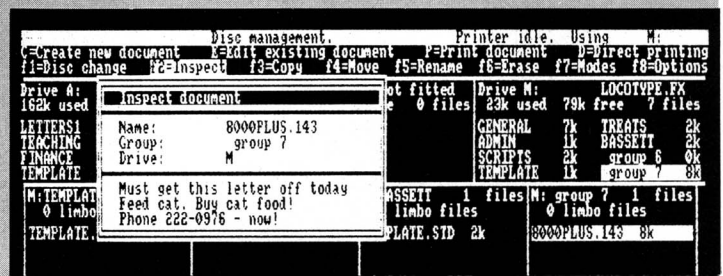

## Sorting it out

Owners of Arnor's Prospell spelling checker program have a handy way of sorting lists of words into alphabetical order.

Prospell has an option in its Dictionary Utilities submenu 'Build Dictionary'. This takes a file of words, compares them to the current dictionary, and writes the unrecognised words out to disc. The words are output in sorted order.

You will need to have a new dictionary disc with no words at all in it (so that all the words in your file are flagged as unrecognised). To do this, choose the 'Initialise Dictionary' option on the Dictionary Utilities submenu, and put in a spare side of a disc into the A drive.

Now when you choose 'Build Dictionary', you will be asked whether you want to build to a dictionary or a file – choose 'File'. With your new blank dictionary in the A drive, and your file of words to be sorted in B or M, answer the prompts for input and output file names.

The input file can be a straight LocoScript file, but the output will always be an ASCII file. To read an ASCII file back into LocoScript, use the [f7] Insert Text command while editing. You will find that the output file contains all the words in the input file in sorted order, although they will be all in capital letters.

*David Fisk, Arnor Ltd*

Somerton College of Higher Education  
45 Polham Lane  
Somerton  
Somerset

17th April 1987

Answer all the questions on the sheet twice each.  
Do not write on more than one side of the paper at once.

- How do you spell:  
(a) Cat \_\_\_\_\_  
(b) Dog \_\_\_\_\_
- At the 1946 Irish sheepdog trials, how many were acquitted? \_\_\_\_\_
- Write down all you know \_\_\_\_\_  
\_\_\_\_\_  
\_\_\_\_\_

▲ A sample questionnaire ruled with the help of [PASTE] L

# SOFTWARE AT LOW PRICES

AMSOFT	
Purchase Ledger .....	31.95
Nominal .....	31.95
Supercalc2 .....	47.99
ASHTON-TATE	
dBase II .....	115.99
CAMSOFT	
Cambase .....	47.95
CAXTON	
Condor I .....	97.95
Scratchpad + .....	57.95
Cardbox .....	57.95
Touch 'n' Go .....	21.99
Brainstorm .....	47.95
COMPSOFT	
Delta .....	97.95
dBASE	
Plan It .....	21.95
DIGITAL	
C Basic compiler .....	46.95
Pascal MT4 .....	47.95
FIRST SOFTWARE	
dBase II .....	115.95
GEMINI	
Datagem .....	37.95
HEADLINE COMMUNICATIONS	
Supercalc 2 Tutorial .....	7.99
CP/M+ Tutorial .....	7.95
Tutorial & Locoscript .....	£7.95

MAP	
Ledger/Stock Control .....	147.85
Invoicing/Sales Ledger .....	47.95
Purchasing Ledger .....	47.95
Nominal Ledger .....	47.95
Stock Control .....	47.95
Payroll .....	47.95
MICROPRO	
Pocket Calcstar .....	37.95
Pocket Wordstar deluxe .....	67.95
Pocket Wordstar .....	47.95
SAGESOFT	
Magic Filer .....	67.95
Stock & Invoicing .....	67.95
Popular Accounts Plus .....	147.95
Popular Super Combo .....	197.95
Sage dBase retrieve .....	67.95
MODEMS/CHIT-CHAT	
Chit-Chat E mail .....	67.95
Chit-Chat View Data .....	67.95
Chit-Chat Combo .....	97.95
Communications Combo .....	255.85
SANDPIPER SOFTWARE	
Integrated Accounts .....	147.99
Payroll .....	77.95
File Manager .....	97.95
Accounts and Payroll .....	197.95
Accounts with Stock .....	196.95
SYSTEMBUILD	
Landscape .....	17.95
UTILITIES	
Arcom Poly Typeface II .....	17.95
Poly Typeface III .....	17.95

ARNOR	
Protect .....	77.95
Prospell .....	27.95
CP SOFTWARE	
Graphic, The Universe & Everything .....	17.95
DIGITAL	
Dr Graph .....	47.95
Dr Draw .....	46.95
IANSYST 6128	
Crash course 3.05 .....	22.95
Two finger touch typing .....	21.95
COSMOS	
The French Mistress .....	17.95
The German Master .....	17.95
The Spanish Tutor .....	17.95
MIRRORSOFT	
Graphics Operating System .....	97.95
Fleet Street Editor .....	68.95
TASMAN	
Tasword .....	21.95
Tasprint .....	11.95
CORNIX SOFTWARE	
Card Index .....	32.99
Job Estimating .....	47.95
Management Analyst .....	22.95
Product Costing .....	47.85
AMSOFT	
Cyrus II Chess .....	13.95

DS	
Steve Davis Snooker .....	17.95
Brian Clough F'tball Fortunes ...	15.99
Colossus 4 Chess .....	13.95
CRL	
Tau Ceti .....	17.95
DOMARK	
Trivial Pursuit .....	17.95
GREMLIN GRAPHICS	
Bounder .....	12.99
HEWSON	
H/Row A Traffic Control .....	14.95
INFOCOM	
Hitchhikers Guide .....	21.95
MELBOURNE HOUSE	
Lord of the Rings .....	21.99
MIRRORSOFT	
Strike Force Harrier .....	17.95
OCEAN	
Batman .....	14.95
RAINBIRD	
Starglider .....	21.99
The Pawn .....	21.95
Silicon Dream .....	17.99
VIRGIN GAMES	
Growing Pains Adrian Mole .....	13.95
Scrabble .....	17.95



**EUROMARK INTERNATIONAL LTD**  
**92 A High Street Edgware Middlesex HA8 7HF**  
**Telephone 01-951 1147/5771**  
**Telex: 295441 Busy B. Fax 01-209 1231**



DEALERS ENQUIRIES WELCOME

## Crown Dust Covers now offer two types of dust cover

### STANDARD CLEAR PVC

- ▲ Flame retardant to British standard
- ▲ On/off indicator light can be seen through the cover
- ▲ Anti-static

- ▲ All seams and edges stitched and bound
- ▲ Ultra-violet additive helps prevent discolouration by sunlight
- ▲ Waterproof



**HOW TO ORDER:** Telephone (0984) 33377 for immediate despatch.  
 Post to, CROWN DUST COVERS LTD, Unit 4, 54 Long Street, Williton, Somerset TA4 4QU.  
 PCW dust covers £11.44 per 2 cover set, inc. carriage & VAT  
 also PCW de luxe case £49.39 inc carriage & VAT.

DISCOUNTS for quantity orders  
 DEALER PRICES ON APPLICATION

SCREEN PRINTING OF COMPANY NAME ON ORDERS OVER 25



# THE GOOD SOFTWARE FILE

These pages provide a comprehensive guide to the Amstrad PCW software. Published in three monthly parts, this time it's the turn of Word-processing software, Games and Accounts/ Payroll programs to face the ultimate test. We've set out to cover every important piece of software we could lay our hands on, and to give you enough information to decide whether they are suitable for you.

Any software not listed here either has not been reviewed by us yet, or has been left out to make space for better programs. Games entries have ratings out of five, the others have a brief summary and a list of plus and minus points. Particularly noteworthy programs have an elliptical flash on them. Have fun window shopping!

## ACCOUNTS • PAYROLL

### Money Manager

£24.95 • Connect Systems Ltd • 01-743 9792

A personal accounts package, which might at a pinch serve a fledgling small business. It acts as a daily diary, over 12 months, recording all incomings and outgoings between up to 9 accounts. Transactions can be given codes to group like ones together, and simple reports can be printed

#### PLUSES • MINUSES

- ☑ Simple menu and screen entry of data
- ☑ Standing orders can be defined for each month
- ☑ Detailed and summary statements can be printed out
- ☑ VAT reports can be separated out
- ☑ Can present results as bar charts
- ☑ The 24-page manual does not give enough examples
- ☑ The statement format is not very flexible
- ☑ Transfers between accounts are not cross-referenced

### Sagesoft Accounts

£99.00 • Sagesoft • 091-284 7077

An integrated accounts package consisting of purchase, sales and nominal ledgers. For another £50 you can buy Accounts Plus which also has invoicing and stock control. The package is aimed at small companies with the emphasis on ease of setting up. But there are a number of limitations — in particular the package cannot cope too easily with rapidly increasing numbers of customers and suppliers.

#### PLUSES • MINUSES

- ☑ Clean, tidy and logical screen layouts and menus
- ☑ Easy to set up and use with excellent documentation
- ☑ Good audit trails and VAT reports
- ☑ Can produce formatted trial balances
- ☑ Restrictive account numbering system
- ☑ Small batch sizes
- ☑ Only single Nominal ledger and VAT analysis per item
- ☑ Does not cater for settlement discounts
- ☑ Won't print remittance advice slips

### Compact Accounts

£199.99 • Compact Software Ltd • 0306 887373

VERSATILE!

Another very large integrated package supplied on several discs and consisting of sales, purchase and nominal ledger together with invoicing. The package is available

on much larger micros, and since the format in which data is produced is the same as on PCWs, the system is particularly suitable for users planning to upgrade their hardware at a later date. The programs' anti-piracy system means you have to use the original discs in the A drive. This means the system is not very suitable for use on an 8256.

#### PLUSES • MINUSES

- ☑ Audit trails are an auditor's dream.
- ☑ Includes a facility to allow data to be used in WordStar, Multiplan or SuperCalc 2.
- ☑ Superb prepayment facility.
- ☑ Can run a number of companies separately.
- ☑ Easily transported to bigger computers.
- ☑ Lots of disc swapping necessary.
- ☑ Can be slow to use — it runs in Mallard Basic.
- ☑ A couple of mildly annoying quirks in cash allocation routine and account code system.

### Camssoft PSIL

£149.95 • Cambrian Software • 0766 831878

GOOD FOR SMALL CO.

Consists of five integrated packages: Sales, purchase and nominal ledgers, invoicing and stock control. In terms of sophistication it falls somewhere between the Sagesoft package and the larger systems from MAP and Compact. But it's easier to run than the larger packages since all the software can be squeezed into the M drive. Good package for a small company.

#### PLUSES • MINUSES

- ☑ Comes installed for PCWs and can be run efficiently by 8256 or 8512.
- ☑ No need for pre-printed stationery.
- ☑ Excellent sort and search facilities.
- ☑ Invoices shown on screen as you create them.
- ☑ Constant need to input full five-digit account codes.
- ☑ No final accounts reports available on nominal ledger.
- ☑ No facility to run the ledgers in different accounting periods.

### M.A.P. Accounts

£149.00 • MAP Computer Systems • 061-624 5662/3

POWERFUL!

This is a very powerful package moved onto the PCW at a fraction of its cost on larger micros. The size makes it a little cumbersome to use, but apart from that there are very few significant problems. The integrated suite includes the same five modules as Camssoft, but they are supplied on four sides of disc, making it effectively impossible for the software to be run as an integrated system on an unexpanded 8256.

#### PLUSES • MINUSES

- ☑ A very comprehensive and professional package
- ☑ Very good audit trails.
- ☑ It's possible to run the sales and purchase ledgers over a different time period from the nominal.
- ☑ Facility for handling prepayments and accruals

- Able to print full management accounts.
- The size of the programs means lots of disc swapping.
- All normal responses need to be in upper case.

### Small Business Accounts Made Simple SMALL TRADERS BEST BUY

£99.95 • Micro Simplex • 0625 615375

An accounts and VAT system specially designed for small businesses. Uses a special system of trading weeks and quarters, and links in bank transactions etc.

#### PLUSES • MINUSES

- Uses M drive to speed operation
- Comprehensive, easy-to-follow manual
- Handles special retailer VAT schemes
- Easy to use menus
- Very good audit trails
- Facility to provide simple profit and loss figures
- Use of accounting weeks makes it rather rigid
- Only suitable for simple cash trades

### Sandpiper Accounts

£149.95 • Sandpiper Software • 0978 358832

This package is described as a 'simplified' integrated system and is aimed at inexperienced users. But although it offers a large number of features at a competitive price, it suffers from some serious drawbacks. In particular the limited audit and enquiry facilities will make it unsuitable for many businesses.

#### PLUSES • MINUSES

- Comes ready installed to run from the M drive.
- Price includes three months' telephone support.
- Very poor audit trails and lack of detail on nominal ledger.
- Analysis of sales and purchases very slow.
- It would be easy to wipe off transactions by accident mid month.
- The documentation is confusing.

### Cavalier Install

£99.95 • Load & Run • 0322 72116/73128

A comprehensive integrated package. Comprises 'Intact' accounts and 'Instock' stock control, available separately for £59.95 each. Well designed, easy to run and powerful enough for most businesses.

#### PLUSES • MINUSES

- Other packages (eg. 'Teleadd' address book) can be added too
- Comprehensive range of features when used as a package.
- Sophisticated features in Instock section covering pricing and order suggestion.
- Flexible accounts, traps most mistakes and gives useful report summaries
- Interesting forward planning facility in stock control
- Manual gives you a confusing number of options

### Personal Tax Planner

£24.95 • Digita • 03954 5059

**MONEY SAVER!**

A program which takes you through all the stages of filling out a tax return, and will tell you how big a rebate you are due (if any!)

#### PLUSES • MINUSES

- Simple to use
- Needs almost no knowledge of tax laws
- Keeps your income tax details all in one place, and prints out a neat summary
- You have to pay £10 if you want another year's allowances to be used
- Limited application -- you might only use it once a year

### Simple Accounts

£34.95 • Cornix Software Ltd • 0462 682989

As simple to set up and run as the name implies although it is limited in its aims and can be slow. Does the basics for a small firm in sales and purchase ledgers quite efficiently.

#### PLUSES • MINUSES

- Needs little accounting experience to work effectively.
- Flexible enough to suit most small company set-ups.
- Runs in Basic and can be slow.
- Limited number of entries in each period so choose the accounting period carefully.
- Limited in its aims.

### MAP Payroll

£49.00 • MAP Computer Systems • 061-624 5662

**GOODVALUE**

#### PLUSES • MINUSES

- Can amend and re-run at any stage (even after printing payslips)
- Cash analysis is broken down into departments
- System prevents re-use or amendment of leavers
- Facility to hold up to 40 standard hourly and weekly wage rates
- No SSP calculation facility (although there is provision to record amounts paid)
- Programs necessitate a lot of disc swapping
- Automatic amendment of tax code changes does not print a record of alterations made

### Camsoft Payroll

£49.95 • Cambrian Software • 0766 831878

**SIMPLE AND FLEXIBLE**

#### PLUSES • MINUSES

- Full payslip displayed on screen and any item can be amended immediately -- when accepted the payslip is printed at once with an optional file copy
- Facility for freehand narrative on any payslip
- Uses M drive for programs to speed operation
- Built in on-screen help facility
- Selective search and sort routine for output to screen, printer or disc
- Uses alphanumeric employee codes
- Screen menus somewhat untidy and sometimes difficult to follow
- No listing of cheques

### Compact Payroll

£99.95 • Compact Software Ltd • 0306 887373

#### PLUSES • MINUSES

- Supplied with test data
- Good facility to change employees tax codes following budget
- Can run payroll for several companies
- Same program available for PC compatibles, and the data is transportable
- Must be run from the master discs
- Programs spread over two side of a disc and run in BASIC
- Needs use of data input form and calculation of a check digit for each employee processed
- Once payslips are printed there is no chance of changing anything
- Most expensive payroll program

### Sagesoft Popular Payroll

£69.95 • Sagesoft • 091-284 7077

#### PLUSES • MINUSES

- Any or all employees payroll can be rerun at any stage up to final update
- Full pay history available for all employees and leavers
- Calculates average pay for holidays etc
- Very easy to install
- Limited number of additions/deductions
- Doesn't print a list of cheques
- No analysis of additions/deductions

### Colleen Payroll

£29.95 • Colleen Ltd • 0443 434846

#### PLUSES • MINUSES

- Comprehensive employee details
- Calculates wages rates from annual total
- Shows payslip on screen while creating
- Complete with good report generator
- Runs in BASIC and menu selections involve a lot of responses
- Comes with Tax and NI details blank with advice to look up details!
- Generally very complicated to implement
- Attempts to amend individual employees' pay after an automatic run (as advised in the manual) caused a program crash

### Sandpiper Payroll

£79.95 • Sandpiper Software • 0978 355333

#### PLUSES • MINUSES

- Uses M drive to speed operation.
- Comprehensive SSP records.
- Cash analysis broken down into departments.
- Gives on screen review of payslips and allows amendments after payslips have been printed.
- Can only process one department at a time.
- Complicated installation and software protection procedures.
- Slow cursor movement and unhelpful positioning while making entries.
- Documentation not very thorough.

# WORD PROCESSING

The PCW already comes bundled with a free word processor, LocoScript, so you might not think of buying another one as a priority. In fact, whatever you may have read in magazines, LocoScript is a pretty good word processor and you won't find many editing and layout functions that it doesn't have. Its principal disadvantage used to be its slowness, but with this month's release of LocoScript 2 all that has changed.

# The Best! from HiSoft

## Devpac80 Ver. 2

Devpac has always been a popular Z80 development system used by Software Houses all over the world since we first introduced it for CP/M over 6 years ago. Many regard it as a standard to work from. Now we have extended the standard to produce the most powerful Z80 development package yet seen and still at the same price as before, half the price of certain other systems!

- fully-integrated screen editor, remembers your assembly errors and takes you straight there for correction.
- standard Zilog macros with strings, nested conditionals & text include, full expression handling with absolute and relative values.
- produces standard .REL files or .COM files. .REL files allow you to link the output with the output of most other languages e.g. CBASIC™, ProPascal™, ProFORTRAN™, all MicroSoft languages etc. The REL format is a standard 8080/Z80 linker format, don't be fooled by substitute formats.
- assembler produces standard .SYM symbol table files for use with the symbolic debugger or with debuggers from MicroSoft and Digital Research.
- the debugger is symbolic i.e. you can see the labels you used when assembling in the code that you are debugging.
- debugger uses full conditional breakpoints and watchpoints so that you can even profile your program to highlight slow areas.

All this power with an extensive, quality ring-bound User's Manual for the incredible price of

**£39.95**

## HiSoft C / Aztec C

C is now a very popular and important language. We offer two entry points, one for beginners or casual users and one for the experienced C programmer.

### HiSoft C £39.95

- fully-integrated editor, reports your error and takes you to the rogue line, ready for correction.
- super-fast and compact code.
- Kernighan/Ritchie without floating-point or linkage.
- Special Offer!** Supplied with tutorial book **C at a Glance free!** Make sure you use the coupon below for this offer.

### Aztec C' Prime £79.95

- industry-standard compiler with upgrade path to developer and commercial versions.
- assembler, linker and object modules all supplied. produces efficient, fast code.
- full Kernighan/Ritchie with floating-point.
- versions for CPC6128 / PCW / PC1512 computers.

We have many other high quality language/utility products for the Amstrad computers including HiSoft Pascal80, Nevada COBOL & FORTRAN (£39.95 each), FTL Modula-2 (£54.95), ZBASIC (£49.95), The Knife (£12.95), HiSoft FORTH (£19.95), Write Hand Man (£29.95) and more. Please write or phone for our latest catalogue.

Order by phone using Access/Visa or by post. Prices include VAT and P&P. Goods rushed to you by First Class Post.

**HiSoft** The Old School, Greenfield, Bedford MK45 5DE ☎ (0525) 718181

## FINGER TIP COMMUNICATION

### HERE'S WHAT DIALUP CAN DO FOR YOU!

#### SMALL BUSINESSES

- Telex ● Electronic Mail ● Company Searches ● Information ●
- Search and Scan Newspapers ●

#### HOME USERS

- Order Goods ● Games ● Free Software ● Chat Line ● Instant News ●

**WHY DIALUP?** It is specifically designed to be easy to use - perfect if you have little or no knowledge of comms! With DIALUP you can access services like Prestel, Telecom Gold, Microlink and Micronet. You can also copy software, send and receive a message, file or telex using simple or sophisticated error checking protocols. DIALUP also has support for BT's Multistream EPAD service - less line noise and cheaper costs.

**WHAT DO YOU NEED?** ● A MICRO - currently DIALUP is available for the Amstrad PC1512 and the PCW, IBM PC/AT/XT or compatible, BBC Model B/B+/Master/Compact, RM Nimbus/480Z/380Z ● A MODEM - most Hayes compatible or manual dial modems ● A TELEPHONE LINE - your existing line will possibly do very nicely, and of course ● DIALUP Communications Software!



**DIALUP PERSONAL**  
COMMUNICATIONS SOFTWARE

DIALUP PERSONAL costs just £89.95 (inc. VAT) + £2.95 p&p (Total £92.90). That includes an extremely comprehensive user manual and cable you need to connect your micro to the modem. DIALUP is also available in special pack with the WS4000 Modem at a special price of £259.95 (inc. VAT) + £5.50 p&p (£265.45).

PLEASE SEND ME:

- DIALUP for a . . . Micro     DIALUP & WS4000 for a . . . Micro  
 More information on DIALUP PERSONAL     COMMERCIAL     EDUCATIONAL

NAME .....

ADDRESS .....

POST CODE .....

TEL. ....

I enclose cheque for ..... made payable to PMS Communications Ltd, alternatively telephone your ACCESS order to 021-643 7688.

Please send to PMS Communications Ltd,

Norfolk House, Smallbrook Queensway, Birmingham B5 4LJ. Tel. 021-643 7688.

**ONLY £89.95** + P&P PC8000 /06

**INCL. FREE COMMS CABLE**

## COMMUNICATIONS SOFTWARE

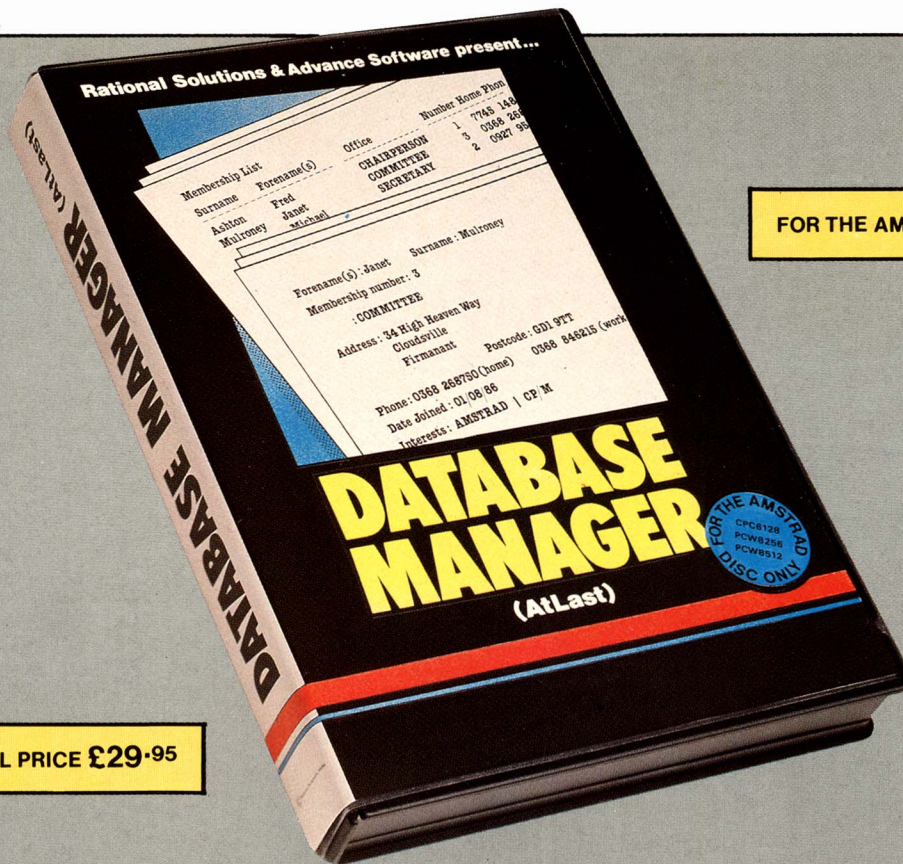

FOR THE AMSTRAD CPC 6128 PCW 8256/8512

RECOMMENDED RETAIL PRICE £29.95

- The Database Manager combines impressive flexibility; huge data capacity and operational simplicity with an ability to perform tasks other databases are incapable of handling.
- The Database Manager is a Multi File database and can access, not just one file at a time, but can relate data between files; allowing student records to be related to course and lecturer records; or an estate agent to relate customer files to properties.
- There are up to 10 data files each with up to 32,000 records of more than 2,000 characters. With individual field elements of a maximum 79 characters, the Database Manager can handle almost any application for clubs, businesses, schools and individuals.
- Yet, in spite of its massive capacity, power and flexibility, the Database Manager is **incredibly easy** to use with **full menus**, **helpful information** and **on screen prompts** — usually requiring only **single key responses**.

The Database Manager, **don't** settle for less!

100 PAGE MANUAL WRITTEN BY ANDREW CLARKE  
AUTHOR OF CPM + ON THE AMSTRAD INCLUDED

ADVANCE • SOFTWARE • PROMOTIONS • LIMITED

17 • STAPLE TYE • HARLOW • ESSEX • CM18 7LX • TEL • (0279) 412441

FULL TELEPHONE SUPPORT AVAILABLE

MAIL ORDER - RATIONAL SOLUTIONS, 9 ROSE HILL RD., LONDON SW18 2NY  
TRADE ENQUIRIES - ADVANCE SOFTWARE PROMOTIONS - AS ABOVE

# THE GOOD SOFTWARE FILE

## WORD-PROCESSORS

There are advantages to be had in changing. LocoScript cannot run from CP/M, and this may cause you trouble. Also, you often get a spelling checker thrown in free — look for one which allows its dictionary to be modified so you can include non-American spellings.

Many other word processors have a built in "mail merger" program. This is a way of doing bulk mailshots; you store your address list in a data file, and write a letter with labelled gaps where you want the names and addresses to go. Then, when you print, the letter comes out once for each address, with the the information in its correct place.

One thing's for sure, whatever word processor you buy it will be totally different to operate from LocoScript. The PCW keyboard is custom built to run LocoScript, so if you change you will have to get used to some arcane choices of keys to do even simple operations. Also, you won't be able (very easily) to use all the printer styles that you can from LocoScript, although there will be enough to get by with.

### LocoSpell

£39.95 • Locomotive/Amsoft • See special offers

A MUST FOR  
LOCOSCRIPTERS

The ultimate spelling checker for LocoScript users. It is run as a simple menu choice while you are editing a document normally, and you can check either an entire document or only a paragraph. When it finds an error, it suggests a correction for you. Runs reasonably fast, given LocoScript's inherent sloth in the first place.

#### PLUSES • MINUSES

- Runs totally from within LocoScript
- Can do small sections of a file
- Suggests alternatives for misspelled words
- Reformats the text as it makes corrections
- Provides the much-missed LocoScript word counter
- Can't remove spellings you don't like (eg. -ize) from the dictionary
- The manual gets bogged down in confusing details sometimes
- Slow at scrolling the dictionary window looking for correct spellings

### Prospell

£29.95 • Arnor • 01-684 8009

BEST BUY!

This is a stand-alone spelling checker suitable for use with almost all word processors that run on the PCW machines. It can read LocoScript, WordStar and plain ASCII files. It flags up each wrong word as it finds it, and allows you to make corrections directly, view the context, change the dictionary etc. Speed is not bad.

#### PLUSES • MINUSES

- Can check LocoScript and WordStar documents directly
- Can display the context of a word to remind you what it should be
- Can edit misspellings directly from Prospell
- Can update the dictionary interactively
- It has anagram and crossworld solvers too
- It processes files of more than 15k or so in separate sections
- You can't copy the dictionary to the M drive for speed

### LocoMail

£39.95 • Locomotive Software/Amsoft • 0277 230222

BEST BUY!

As a mailmerger for LocoScript documents, it's difficult to see how anything could be much better than this. It runs directly from LocoScript, so you never have to use CP/M, and can process any LocoScript commands. Has many advanced features, and is highly recommended for all LocoScript users.

#### PLUSES • MINUSES

- You don't have to run it from CP/M
- Can print any LocoScript text formatting commands
- Can automatically rejustify paragraphs after insertion
- Can insert numeric calculations into letters
- Can read data from non-LoCoScript (ie. ASCII) files
- Large manual, with example files on disc
- No way to sort and filter addresses before a print run

### Qmail

£29.95 • Proteus Computing • 01-748 2302

GREAT  
VALUE

A mail merger specifically designed to work with LocoScript files. It scores over LocoMail in that it has a simple but effective database system to allow you to choose your target for a mailshot by marking them with 'attributes' and selecting -- eg. only those customers who bought your product X.

#### PLUSES • MINUSES

- Read LocoScript files unconverted
- Prints all LocoScript commands properly

- Well-designed database is ideal for mailmerging
- Database 'attributes' provide an advanced selection capability
- Manual is lacking in examples

### Pocket WordStar

£49.95 • MicroPro/Davis Ruben Associates • 0386 841181

IT'S  
WORDSTAR!

To many business users, word processing means using WordStar. Almost every feature you could need in a text processor is here and despite the title this "Pocket" version has all the features of the original. It has also been customised to use the PCW's full screen width and some of the keypad keys. However the program can be difficult to learn and some of the margin and formatting commands are cumbersome. Efficient and proven, but it is now showing its age and there are alternatives unless you are committed to WordStar already. For £20 extra, you can get the De Luxe version with spelling checker.

#### PLUSES • MINUSES

- Probably the world's most widely used word-processor
- Documentation is complex but well structured
- Includes a mail merge utility
- The keystroke commands are fully described on on-screen menus
- You can save your own favourite customised version
- Doesn't make full use of the PCW keyboard and printer
- Page and margin formatting commands are awkward to use

### NewWord

£69.00 • NewStar Software Ltd • 0277 220573

POWERFUL  
AND PROVEN

NewWord sets out to exploit the WordStar market by doing just the same job but better. It uses much the same key commands as WordStar, and will even edit WordStar document files. It comes with a spelling checker. On-screen help is much better than WordStar, but the commands, being restricted by compatibility, are still as obscure.

#### PLUSES • MINUSES

- Can do everything WordStar can, and even edit WordStar files
- Makes good use of the PCW screen -- actually shows underlining and bold text.
- Clearer help messages than WordStar and good tutorial manual.
- Has full reformatting of text within its mail merge
- Good spelling checker as part of the price
- Can un-erase words and lines -- useful for moving them around
- Weak on use of the keypad and printer support
- Many of WordStar's disadvantages too, like formatting troubles and obscure commands.

### Tasword 8000

£24.95 • Tasman Software • 0532 438301

An established word processor that is well tried and tested on Amstrad's CPC machines. Tasword's strength is its printer handling — it provides a host of customisation options for different printers, and a variety of print fonts too. But if you enjoy moving blocks of text around to see how they look in different places, Tasword will let you down for speed.

#### PLUSES • MINUSES

- Clear, well structured on-screen help menus
- A variety of printer controls and fonts available
- Includes a reasonable mail merge program
- Moving around big files is fast
- You can easily create and save a customised version of the program
- Doesn't treat [RETURN] as a character — it can lose paragraph endings.
- Reformatting text blocks is quirky
- Documentation is a bit brief
- The search and replace function is limited and very slow

### AnsibleIndex

£49.50 • Ansible Information • 0672 62576

AUTHORS'  
BEST BUY

Takes a LocoScript file and compiles an alphabetical index with page numbers from all the words marked. You mark the words to be indexed by using LocoScript's (RV) code. The price includes the AnsibleCheck word counter /proof reader program too, which is also available separately at £19.50.

#### PLUSES • MINUSES

- LocoScript documents don't have to be converted to ASCII
- Can 'invert' phrases, eg. 'Smith, Fred' rather than 'Fred Smith'
- Can produce a single index combining several different LocoScript files
- Readable and comprehensive manual
- The output index is not a LocoScript document until you convert it
- You can only index words which appear literally, not general topics
- The price will deter casual users

### LernLoco

£16.95 • Minerva Systems • 0392 37756

A set of LocoScript files on a disc which are designed to be a step-by-step guide to using LocoScript. As you go through the lessons in turn, you print them out to form your own manual.

# CAPITOL

**HOTLINE 0705 380531**

## SPECIAL OFFERS

CASH TRADER	£79
SHOE BOX	£99
TIME KEEPER	£49
MAIL FLOW III	£39
DBASE II	£85
Free Lockable storage box with:	
50x5¼ DS/DD Disks	£34:95
100x5¼ DS/DD disks	£64:95

**KUSTOM  
COVERS**

PC1512-2 part set	£11:95
PCW 8256-3 part set	£9:95
Amstrad 6128-2 part set	£7:50
Amstrad 464-2 part set	£7:50
DMP 2/3000	£4:95

**DEALER, EDUCATION,  
AND COUNTY COUNCIL  
ENQUIRIES WELCOME.**

## HARDWARE

1512 SD Mono	£499
1512 DD Mono	£625
1512 DD Colour	£830
1512 HD20 Mono	£1025
1512 HD20 Colour	£1220
PCW 8256	£430
PCW 8512	£550
Opus PCII SD Mono	£565
Opus PCII DD Mono	£800
Opus PCII 20 Meg HD	£1125

## PRINTERS

Juki 6100	£399
Juki 6200	£489
Cannon PW1080A	£349
MP201	£399
MP165	£239
Star NL10	£349

**FOR FURNITURE &  
PRINTER RIBBONS, RING  
FOR CATALOGUE.**

## PCW8256 SOFTWARE

### SANDPIPER

Sandpiper Accounts	£140
Payroll	£75
File Manager	£95
Accounts + Payroll	£195
Intergrated Accounts	£195

### HISOFT

Dev Pack 80	£34:95
Pascal	£34:95
'C'	£34:95
Knife	£11:00
Torch	£11:00
Art in Pascal	£11:00

### MICRO-PRO

Wordstar	£40:00
Wordstar Deluxe	£60:00

### LINC

Teach Yourself Locoscript	£12.95
---------------------------	--------

### CAXTON

Cardbox	£42
Condor One	£82
Scratch Pad +	£45
Touch N'Go	£15
Smart Key	£39
Brain Storm	£39

### CAMSOFT

Integrated Accounts	£149:95
Pay Roll	£49:95
Cambase	£49:95

### M.A.P.

Integrated Accounts	£145
Payroll	£45
Purchase Ledger	£45
Sales + Invoicing	£45

### COMPACT

Integrated Accounts	£185
Order Processing	£75
Nominal Ledger	£75
Daybook	£75
Nucleus	£75
Sales Ledger	£75
Sales Invoicing	£75
Purchase Ledger	£75

### DATARUN

Datafile 1	£26
------------	-----

### ANAGRAM

Sales Ledger	£86:25
Purchase Ledger	£86:25
Stock Control	£86:25

### ARNOR

Prospell	£26
Protext	£79

## ACCESSORIES

8256 Wiz Card	£17:00
8256 Joystick Interface	£13:00
Mouse Mat	£3:95
Parallel Printer Splitter	£42:50

## DISKS

KAO Branded 5¼ DS/DD	£8:95
Unbranded 5¼ DS/DD	£7:95
Maxel CF2 3" Disk	£24:95

## JOYSTICKS

Cheetah 125 +	£7:95
Mach One +	£12:95
Professional	£17:95

## DISK STORAGE BOXES

Hold 50x5¼ Disks	£9:95
Hold 100 x5¼ Disks	£14:95

Please make cheques payable to:  
CAPITOL, F3, Railway Triangle, Farlington, Portsmouth,  
Hampshire, PO6 1TG.  
PLEASE SUPPLY

NAME .....  
ADDRESS .....  
POSTCODE .....  
DAY TEL.NO. ....  
SIGNED .....

Please Debit My ACCESS/VISA The value of £ .....  
All prices include VAT and postage in the UK. Overseas please add £1.50.



**Make your  
PCW 8256  
Portable!**



**EXPORT  
ORDERS**  
Send cheque for  
£27.75  
Sterling (INC P&P)  
or Access/Barclaycard  
Mastercard

# with the new AMSTRAD 8256 TRANSPORTER

*Holds monitor, keyboard, printer, modem,  
cables and manual with separate pockets  
for disks.*

Strongly made in UK with adjustable nylon webbing  
shoulder/handle strap. Measures 17"x16½"x13".

Protective boards inside.

Only £19.75 inc. VAT plus £2 p&p

Fast delivery – ex stock.

*Ideal for taking your computer anywhere;  
home, on-site visits, overseas. Protects  
against damage in back of car etc.*

*Leaves both hands free.*

Fill in the coupon below, or if you are a  
credit card holder ring 01-749 9692  
(24hrs) to place your order for immediate  
despatch.



Trade Enquiries welcomed.



Vidix Case Company Ltd. EP, Tech West Centre,  
Warple Way, FREEPOST, London W3 0BR.

To: Vidix Case Company Ltd., EP, Tech West Centre,  
Warple Way, FREEPOST, London W3 0BR.

Please rush me \_\_\_\_\_ (qty.) Transporters

I enclose cheque for £ \_\_\_\_\_ (PCW/PC) please delete  
payable to Vidix Case Company Ltd. OR

Please debit by Access/Visa

card no. \_\_\_\_\_

Signature \_\_\_\_\_

Name \_\_\_\_\_

Address \_\_\_\_\_

Postcode \_\_\_\_\_

Telephone No. \_\_\_\_\_

# THE GOOD SOFTWARE FILE

WORD-PROCESSORS GAMES

## PLUSES • MINUSES

- ☑ Covers most LocoScript's features in well organised lessons
- ☑ Contains many useful tips and techniques
- ☑ Style of writing is patronising
- ☑ It is annoying to have to print out the documents as you go

## Teach Yourself LocoScript

£14.95 • LINC • 0273 776576

Another disc of teach-yourself lessons for LocoScript. Better written and organised than LernLoco. The advantage over a book is that you can try things out as soon as you read about them, and see the effect on the text you are reading.

## PLUSES • MINUSES

- ☑ Well organised lessons for you to browse through as you like
- ☑ Well-pitched style of writing does not talk down to you

## Protect

£79.95 • Arnor • 01-684 8009

**FAST AND POWERFUL**

A powerful challenger for WordStar/NewWord as the best CP/M wordprocessor. Very fast at moving around large files, and packed with features. Works with key combinations rather than menus, but doesn't stick to WordStar conventions.

## PLUSES • MINUSES

- ☑ Complete with spelling checker and mail merger
- ☑ Lets you work with two documents at once
- ☑ You can do all of CP/M's functions without ever leaving the word processor
- ☑ Very fast at moving around, doing exchanges and so on
- ☑ Forces you to learn another new set of control keys to use it
- ☑ Not as slick as LocoScript in its printer controls

## Grammatik

£49.95 • Optronics • 01-892 8455

A program which attempts to check your writing style (not spelling). It looks for cliches, tautologies, sexism and so on. Potentially very useful, but to be taken with a pinch of salt.

## PLUSES • MINUSES

- ☑ Shows up grammatical problems you never knew you had
- ☑ Marks up text for re-editing
- ☑ Lets you build up your own jargon dictionaries
- ☑ Needs to be used intelligently
- ☑ Can't spot contextual errors
- ☑ A little pricy for what it does

# GAMES

No one could have predicted the remarkable way in which games software has taken off on the PCWs. On the face of it, the machine is not ideally built for games, but software houses have proved that impressive results can be obtained on it, and not just with text-based games – your 8000 is capable of amazing graphics! The entertainment software available divides into two main categories:

ADVENTURES are probably the most common on the PCW.

These are defined (by us anyway) as games controlled by typed keyboard commands. The program describes a scenario and you, the player have to respond by typing things like: GET SWORD or POLISH ORB WITH THE VELVET CLOTH. These programs vary greatly in their ability to recognise and respond to your instructions, and at their best seem unbelievably intelligent. Some of them include pictures of the various game locations, but these tend to play little part in actual game-play. We rate these by Atmosphere, Interaction, Challenge and Value.

In ARCADE GAMES, an animated character is moved onscreen by direct keyboard (or joystick) control. You press a key for "Left" and the character goes left or shoots something. We rate these by Graphics, Addictiveness, Lasting Appeal and Value.

## Blackstar

£14.95 • CRL • 01-533 2918

A traditional text adventure with large playing area. Your aim is to explore the mysterious Castle Blackstar and its caverns in search of a power orb.

ATMOSPHERE ■■■■■  
INTERACTION ■■■□□  
CHALLENGE ■■■■■  
VALUE VERDICT ■■■■■

## The Archers

£13.00 • Mosaic/WHS Distributors • 0533 551196

**SIMPLE AND HUMOROUS**

By answering a series of multiple choice questions, you decide the fate of your favourite Archers characters. If the ratings drop, you get the boot.

GRAPHICS ■■■□□  
ADDICTIVENESS ■■■□□  
LASTING APPEAL ■■■□□  
VALUE VERDICT ■■■□□

## Nemesis

£15.95 • Advantage Software • 0844 52075

A package of four Arnold Blackwood adventure games. The attempts at humour are embarrassing, and the games are thin though well-designed.

ATMOSPHERE ■■■□□  
INTERACTION ■■■□□  
CHALLENGE ■■■□□  
VALUE VERDICT ■■■□□

## The Very Big Cave Adventure

£14.95 • CRL • 01-533 2918

**IRREVERENT!**

Irreverent adventure spoof with plenty of corny jokes, like the credulous bull who guards a gully -- the Gully Bull. A nice break from serious adventuring.

ATMOSPHERE ■■■□□  
INTERACTION ■■■□□  
CHALLENGE ■■■□□  
VALUE VERDICT ■■■□□

## Strike Force Harrier

£19.95 • Mirrorsoft • 01-377 4645

A combat simulation of a Hawker Harrier, designed in conjunction with British Aerospace. Highly detailed, and you'll need to put a few hours in with the manual.

GRAPHICS ■■■□□  
ADDICTIVENESS ■■■□□  
LASTING APPEAL ■■■□□  
VALUE VERDICT ■■■□□

## The Pawn

£24.95 • Rainbird • 01-240 8838

**SOPHISTICATED**

A superb adventure game, with some nice graphics screens. Full of intelligent but zany characters, like wizards and monks. Copes with complex commands.

ATMOSPHERE ■■■■■  
INTERACTION ■■■■■  
CHALLENGE ■■■■■  
VALUE VERDICT ■■■■■

## Annals of Rome

£17.95 • PSS • 0203 667556

A wargaming strategy program, set in the Roman Empire. You guide the Empire through 14 centuries of barbarians. Very detailed, but a bit slow and ragged.

ATMOSPHERE ■■■□□  
INTERACTION ■■■□□  
CHALLENGE ■■■□□  
VALUE VERDICT ■■■□□

## Leather Goddesses of Phobos

£24.95 • Activision • 01-431 1101/2992

**OUTRAGEOUS!**

Lascivious, licentious and lewd -- definitely not for feminists! An excellent adventure game, spoofing up sci-fi and Soho at the same time. With 3D scratch'n'sniff card!

ATMOSPHERE ■■■■■  
INTERACTION ■■■■■  
CHALLENGE ■■■■■  
VALUE VERDICT ■■■■■

## Graham Gooch's Test Cricket

£19.95 • Audiogenic • 0734 303663

A cricket match simulation with good animated graphics. You can select your own teams, control the speed of bowling and striking. For cricket fans.

GRAPHICS ■■■□□  
ADDICTIVENESS ■■■□□  
LASTING APPEAL ■■■□□  
VALUE VERDICT ■■■□□

## Mountain Leader

CPC Minehead • 0643 4851

You are in charge of a mountain expedition. An adventure game which needs a strategic mind, but a bit dull unless you are a mountaineer.

GRAPHICS □□□□  
ADDICTIVENESS ■■■□□  
LASTING APPEAL ■■■□□  
VALUE VERDICT ■■■□□

## Bounder

£13.95 • Gremlin Graphics • 0742 753423

**DIFFERENT AND FUN**

A graphics bouncing-ball game. You have to direct the ball over gaps and around obstacles. An impressive range of locations, screen and features.

GRAPHICS ■■■■■  
ADDICTIVENESS ■■■■■  
LASTING APPEAL ■■■□□  
VALUE VERDICT ■■■■■

### Micro Trivia

£19.99 • Harold Gale Associates • 0902 772771

A sort of Mensa-approved Trivial Pursuit. Minimal graphic content, erratic scoring, and even the questions aren't very interesting.

GRAPHICS ■■■■■  
ADDICTIVENESS ■■■■■  
LASTING APPEAL ■■■■■  
VALUE VERDICT ■■■■■

### Brian Clough's Football Fortunes

£17.95 • CDS • 0302 21134

A computer game with a difference -- it comes with a playing board and dice. You lead your favourite team to league success. Thoughtful and different.

GRAPHICS ■■■■■  
ADDICTIVENESS ■■■■■  
LASTING APPEAL ■■■■■  
VALUE VERDICT ■■■■■

### The Growing Pains of Adrian Mole

£14.95 • Virgin Games • 01-727 8070

Your chance to guide Sue Townsend's famous adolescent through life's tribulations. You answer multiple choice questions, to decide what happens next.

GRAPHICS ■■■■■  
ADDICTIVENESS ■■■■■  
LASTING APPEAL ■■■■■  
VALUE VERDICT ■■■■■

### Tomahawk

£19.95 • Digital Integration • 0276 684959

An Apache helicopter flight simulator. Impressive cockpit view graphics as you engage in combat missions, and can be used with a joystick too.

**DYNAMIC!  
CHALLENGING!**

GRAPHICS ■■■■■  
ADDICTIVENESS ■■■■■  
LASTING APPEAL ■■■■■  
VALUE VERDICT ■■■■■

### Classic Invaders

£12.95 • Digita • 03954 5059

A simple version of the classic arcade game. Oozes nostalgia, but the slowish graphics and lack of sound don't really add up to any great atmosphere.

GRAPHICS ■■■■■  
ADDICTIVENESS ■■■■■  
LASTING APPEAL ■■■■■  
VALUE VERDICT ■■■■■

### Silicon Dreams

£19.95 • Rainbird • 01-240 8838

A trilogy of enjoyable adventure games, and a novella thrown in too. You are Kim Kimberley, secret agent, saving spaceship Snowball 9 from its doom.

ATMOSPHERE ■■■■■  
INTERACTION ■■■■■  
CHALLENGE ■■■■■  
VALUE VERDICT ■■■■■

### Tau Ceti

£19.95 • CRL • 01-533 2918

A superb game combining graphics, adventure, brainpower and shoot-'em-up. You play a space fighter pilot sent to sabotage Tau Ceti III's main reactor.

**ACTION AND  
ADVENTURE**

GRAPHICS ■■■■■  
ADDICTIVENESS ■■■■■  
LASTING APPEAL ■■■■■  
VALUE VERDICT ■■■■■

### Trivial Pursuit

£19.95 • Domark • 01-947 5624

A computer version of the yuppie board game, full of new questions, complete with good graphics and even tunes! Even so, you might prefer the board version.

GRAPHICS ■■■■■  
ADDICTIVENESS ■■■■■  
LASTING APPEAL ■■■■■  
VALUE VERDICT ■■■■■

### Hitch-Hikers' Guide to the Galaxy

£24.99 • Activision • 01-431 1101/2992

In many people's minds, the best adventure program written. Based on Douglas Adams' series, it is ingenious, hilarious and mind-boggling.

**HILARIOUS!  
SUPERB!**

ATMOSPHERE ■■■■■  
INTERACTION ■■■■■  
CHALLENGE ■■■■■  
VALUE VERDICT ■■■■■

### Heroes of Karn

£17.95 • Interceptor Micros • 07356 71145/3711

Traditional adventure game -- you must rescue the four heroes and use their powers. Gives long and detailed descriptions of your progress.

ATMOSPHERE ■■■■■  
INTERACTION ■■■■■  
CHALLENGE ■■■■■  
VALUE VERDICT ■■■■■

### Classic Collection

£14.95 • Tynesoft • 091-414 4611

A disc of three 'classic' games -- versions of Space Invaders, Pacman and Frogger. OK for nostalgia, but the graphics and responses are slow and plodding.

GRAPHICS ■■■■■  
ADDICTIVENESS ■■■■■  
LASTING APPEAL ■■■■■  
VALUE VERDICT ■■■■■

### Scrabble

£19.95 • Virgin Leisure • 01-727 8070

An excellent implementation of the famous game. 1 to 4 people can play the computer, which itself knows a fair few obscure words. Good graphical display.

**PLAYS A  
MEAN GAME!**

GRAPHICS ■■■■■  
ADDICTIVENESS ■■■■■  
LASTING APPEAL ■■■■■  
VALUE VERDICT ■■■■■

### Fairlight

£14.95 • The Edge • 01-831 1801

A fine 3-D graphic adventure with similar screen display to Batman. You must explore a castle prison, battle with numerous enemies and solve puzzles.

GRAPHICS ■■■■■  
ADDICTIVENESS ■■■■■  
LASTING APPEAL ■■■■■  
VALUE VERDICT ■■■■■

### Colossus Chess 4.0

£19.95 • CDS Software • 0302 21134

A very strong chess game which manages to use the time which you spend thinking to plan its strategy. Bags of features, including blindfold games.

GRAPHICS ■■■■■  
ADDICTIVENESS ■■■■■  
LASTING APPEAL ■■■■■  
VALUE VERDICT ■■■■■

### Cyrus II Chess

£15.95 • Amsoft • 0277 230222

A chess game with a stunningly detailed 3-D display. The play is quite strong, and it has several handy features like allowing you to take back a move.

**GREAT  
GRAPHICS!**

GRAPHICS ■■■■■  
ADDICTIVENESS ■■■■■  
LASTING APPEAL ■■■■■  
VALUE VERDICT ■■■■■

### 3D Clock Chess

£15.95 • CP Software • 099382 3463

The '3D' refers to a three dimensional display of a chess clock on the screen. Pretty, but a bit of a gimmick. You can set time limits for moves.

GRAPHICS ■■■■■  
ADDICTIVENESS ■■■■■  
LASTING APPEAL ■■■■■  
VALUE VERDICT ■■■■■

### Bridge Player III

£19.95 • CP Software • 099382 3463

A few of the bids it makes seem a little strange, but as bridge programs on computers go this is pretty good. It claims not to cheat, even though it deals!

GRAPHICS ■■■■■  
ADDICTIVENESS ■■■■■  
LASTING APPEAL ■■■■■  
VALUE VERDICT ■■■■■

### Batman

£14.95 • Ocean Software • 061-832 6633

Good 3-D animated graphics as you guide Batman around Gotham City, looking for the hidden parts of the Batcraft. Good range of hazards, and even a tune!

**GREAT FUN**

GRAPHICS ■■■■■  
ADDICTIVENESS ■■■■■  
LASTING APPEAL ■■■■■  
VALUE VERDICT ■■■■■

## NEXT MONTH

The guide continues next month with the categories of DATABASES, COMMUNICATIONS and GRAPHICS. The month after that will cover SPREADSHEETS, UTILITIES and EDUCATIONAL software, and the month after that it's back to this month's topics.

Our intention is to keep publishing the three parts of the guide in rotation, updating it each month to include all new products. If you would like to see other sections of the guide, back issues of 8000 Plus are available at £1.50 each.

Meanwhile, if you are aware of any significant omissions or errors in the File as published, please let us know. We intend to maintain it as THE authoritative guide to PCW software.

**ACCESS / VISA HOTLINE**  
If you prefer to telephone your order,  
just dial 0458 74011 and ask for credit  
card orders.

## HOW TO ORDER

Just fill in the form  
on left of page

### ORDER FORM No.8

Use this form to order either a subscription or special offers by ticking the items you require. If you want both a subscription AND special offers you must fill in your name and address in BOTH parts of the form as these will be separated by us.

#### SPECIAL OFFER SECTION

Name \_\_\_\_\_

Address \_\_\_\_\_  
\_\_\_\_\_

Post code \_\_\_\_\_

#### NEW CAXTON SOFTWARE OFFER

New low prices include one free blank disc!

- Condor 1 £84.50    Cardbox £47.95  
 Brainstorm £41.75  
 Scratchpad Plus £47.95  
 Touch'n'Go £18.95

#### TIPOFFS BOOK

- £4.95    £1.95 (subscribers only)  
 THE PAWN £19.95  
 SCRABBLE £17.95  
 THINGI £5.95  
 DUST COVER SET £11.95  
 BINDER £4.95  
 HEAD OVER HEELS £11.95  
 AT LAST DATABASE £24.95  
 A.M.S. DESKTOP £69.95

#### INFOCOM GAMES £19.95

- Hitchhiker's    W'bringer    Ballyhoo  
 Zork I    Zork II    Zork III  
 Enchanter    Spellbreaker  
 Sorcerer    Leather Goddesses  
 Suspended    Planetfall  
 Seastalker    Deadline

#### SUBSCRIPTION SECTION

Name \_\_\_\_\_

Address \_\_\_\_\_  
\_\_\_\_\_

Post code \_\_\_\_\_

- 12-mth-SUB. £17.95 (inc TIPOFFS bk)

Your sub will start with June issue only if we receive this order by April 28th.

#### PAYMENT DETAILS

Value of total order   £ \_\_\_\_\_

Payment is by (please circle)

Cheque • PO • Access • Visa

Make payable to FUTURE PUBLISHING LTD.

Your credit card number is \_\_\_\_\_

Expiry date \_\_\_\_\_

Send this form plus payment to  
SPECIAL OFFERS • 8000 PLUS  
SOMERTON • SOMERSET • TA11 7PY

# ATLAST

Only £24.95 disc – save £5!!

Perhaps the most powerful use for your PCW after word-processing is in organising records. The At Last Database Manager from Advance Software is perfectly suited for the job.

It's fast, full-featured, powerful and well-tailored to the needs of the machine. It's also extremely flexible, so you can customise it to a huge range of situations where information needs to be organised and quickly recalled or analysed. An address file, a customer list, a record of your massive LP collection. Whatever.

Features include:

- Easy layout of forms using the built in text editing facilities.
- Number of records limited only by disc space (up to 32,000).
- You can set up relationships between data in different files – very powerful facility!
- Records can be sorted – you can index up to five fields in each file.
- Powerful data transfer utility making it easy to upgrade to this program.
- Nine field types including normal alphanumeric, three types of numeric, date, hours/minutes/seconds, automatic serial numbering.
- Detailed manual and sample data supplied.

All in all, a wonderful way of putting your Amstrad to serious use.

# A.M.S. DESKTOP (with Mouse)

Only £69.95 – save £10!!

This package offers your PCW a unique double-upgrade – hardware and software.

The hardware is a MOUSE, an add-on that's becoming standard issue on more and more computers because of the enormous gain in ease of operation it can give. It plugs into the machine's expansion port and you then control an arrow on screen by simply rolling the mouse over a small area of your desk.

But what makes this package really special is the DESKTOP software. It transforms the traditional CP/M working environment. Instead of having to remember numerous obscure commands you can simply select from a range of pull-down menus. Move the arrow to the selection you want and press the button on the mouse. Point and Click!

Handling files on disc becomes far easier – copying, erasing and moving files can be done quickly and almost intuitively. Then there's a built in telephone/address book, calculator, and clock and even a sliding-number puzzle to while away the odd spare minute.

If you regularly use CP/M software, you're likely to find this package slick, impressive and fun to use.

Rational Solutions & Advance Software present

Membership List	Office	Number	Home Phone
Surname: Fred	CHAIRPERSON	1	7745 148
Ashton Janet	COMMITTEE	3	0368 266
Mulroney Michael	SECRETARY	2	0927 95

Forename(s): Janet   Surname: Mulroney  
Membership number: 3  
Office: COMMITTEE  
Address: 34 High Heaven Way  
Cloudsville  
Firmanant   Postcode: GD1 9TT  
Phone: 0368 268750 (home)   0368 846215 (work)  
Date Joined: 01.08.86  
Interests: AMSTRAD | CP/M

## DATABASE MANAGER

(At Last)

FOR THE AMSTRAD  
CPC128  
PCW8512  
PCW8512

Multi File/ Multi Indexed Database with simple MailMerge Facilities and unlimited defineable print layouts per file. e.g. Labels, Record Cards, Listings etc.

AMX MOUSE

FOR THE AMSTRAD PCW 8256-8512

with AMX DESKTOP PROGRAM

ICON SOFTWARE  
GSX MOUSE DRIVER  
CREATIVE GRAPHICS  
FASTER INTERACTION

SPECIAL OFFERS  
SPECIAL OFFERS

# INFOCOM GAMES

Massive savings on the most sophisticated entertainment software you can buy!

By popular request, here's another chance to buy our favourites from the remarkable range of Infocom adventures at remarkable 8000 Plus prices.

For many people, these programs represent the pinnacle of computer entertainment. What they offer you is NOT graphics or chase-a-blob arcade action. Instead you will find yourself placed in a fictitious world, described in superbly atmospheric detail, and face a sequence of brain-twisting challenges liable to keep you at the keyboard for months.

You communicate with the computer by typing in simple English sentences. If the program doesn't understand, it'll tell you, but the Infocom titles are renowned for their sophistication in handling language, and you'll soon almost believe you're communicating with an intelligent being. In fact, Infocom themselves describe these programs as 'interactive fiction' – it's like finding yourself inside a novel, and having the chance of determining your own destiny.

Until recently these programs were not available in the UK for under £30. And for good reason. For one thing, the programs are massive, containing literally tens of thousands of words of description. For another, they're superbly packaged with all kinds of amusing little extras to accompany the comprehensive and witty documentation.

So to be able to pick them up through us for under £20 a piece is simply remarkable. Pull the curtains, shut out the winter and let your PCW transport you into a different world...

ONLY  
£19.95  
EACH – SAVE AT  
LEAST £5!!

## HITCH-HIKER'S GUIDE TO THE GALAXY

Only £19.95 – save £5!

Arguably the world's wittiest, wackiest adventure game. You take on the famous role of Arthur Dent who only stays alive by discovering ingenious solutions to problems such as that posed by the terrifying Bugblatter Beast, a creature so stupid it thinks that if you can't see it, it can't see you.

Can you work out what to do with a pile of junk mail? Can you learn to understand Vogon poetry? Can you show an obstinate door a sign of intelligence? A game to delight and challenge you for months.

## BALLYHOO

Only £19.95 – save £5!

This one's set in a seedy circus in which you have to discover who has kidnapped the owner's daughter. It's packed from start to finish with puzzles of mind-boggling challenge. How do you get a helium balloon that's only reachable across a tight-rope? How do you soothe a gorilla with music when your radio seems incapable of clear reception? How do you trick a clown into letting you past his wagon door?

There are clues cleverly hidden in the accompanying documentation, but even with their help you'll be in for some long evenings!

## WISHBRINGER

Only £19.95 – save £5!

A stunningly atmospheric game in the Infocom fantasy tradition. The action starts with you, the village postman of Festeron, discovering that a cat belonging to the keeper of the Magicke Shoppe has strangely disappeared. Your only help in solving what rapidly becomes a deep mystery is Wishbringer, a small stone bestowing seven special powers.

This program is especially suitable for people embarking on their first adventure. (It's also, however, been raved over by experts!)

We don't have space to tell you about the rest in detail, except to say they're all SUPERB!

## ZORK I

The one that started it all.

## ZORK II

A great follow up.

## ZORK III

The hardest of the series.

## ENCHANTER

Introductory level classic adventure.

## SPELLBREAKER

Sequel to Enchanter. Harder.

## SORCEROR

Sequel to Spellbreaker. Experts only.

## LEATHER GODDESSES

Saucy, sophisticated romp.

## SUSPENDED

Wake up as a robot! Spooky packaging!

## PLANETFALL

Danger on a hijacked spaceship

## SEASTALKER

Rescue on board a sub. Good first buy.

## DEADLINE

Can you solve the murder in time?



**SUSPENDED**  
A Cryogenic Nightmare

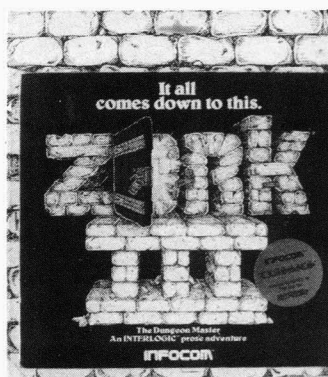

**8000  
PLUS**

# TIPOFFS

The collection: issues 1-6

## A PEAK AT THE CONTENTS On LocoScript

Major articles on Headers and Footers, Tabs and Rulers, Producing Tables, and Laying out Business Letters. Plus scores of tipoffs: Overprinting, Foreign characters, Creating a letterhead, Better Underlining, Typing ahead, Speeding up Long Documents, Using Phrases, Mathematical symbols, Two-column printing, and numerous others.

## On CP/M

Major articles on Disc-Handling (including how to make an auto-start disc), Customising individual keys, Controlling the Printer, RPED, SETSIO and DEVICE. Plus tipoffs on using PIP, function keys, screen printouts, SETKEYS, avoiding problems with DISCKIT, and many more.

## Other TipOffs

Feeding Continuous paper, Label printing, Using A5 paper, Ribbon re-inking, Screen contrast, the free game of Life on your master discs, Boot discs for Cracker and NewWord, and a host of slick little tips for Basic programmers. To mention but a few.

At last the publication you've been clamouring for is here. We've put under a single cover the complete range of TipOffs published in the first six 8000 Plus issues. And there's more: the series of (so we're told) outstanding tutorial articles on LocoScript and CP/M reprinted from those issues.

To tie the whole package together is, published for the first time, a comprehensive index. So now at last you can turn instantly to the information you *know* we published somewhere but can't remember where.

So much material was covered in the first six issues of 8000 Plus this compilation is certain to become a constantly used reference book. Apart from anything else, it offers a chance to catch up on the bumper tips sections in sold-out issues 1 and 2. *The 8000 Plus Tipoffs Collection* is printed on high-quality paper with a colour cover and we think it deserves a permanent place next to your PCW.

SPECIAL OFFERS  
SPECIAL OFFERS  
SPECIAL OFFERS

**8000  
PLUS**

**TIPOFFS**

The collection: issues 1-6

**FREE!**

when you take out a subscription. Or buy it separately for £4.95. (The price for existing subscribers is just £1.95)

Complete  
with index!

## Why You Should Subscribe to 8000 Plus

It costs just £17.95 to take out a 12-month subscription to 8000 Plus. There's several reasons why it makes sense to do so, quite apart from the attraction of the free TipOffs book offered here.

- You're *guaranteed* a copy each month, delivered hot off the press direct to your door. (Many newsagents are selling out within days of publication.)
- You're *protected* against any future price rises.
- You're *entitled* to lower prices on some reader offers.
- You're *supporting* the magazine in the most effective way.

THINGI

## HEAD OVER HEELS

Only £11.95 – save £3!!

Remember *Batman*, the incredibly-animated, bamboozling and totally addictive entertainment from Ocean Software? This one's from the same programmer, and it's even better.

For a start the number of rooms to explore has been *doubled* to an incredible 300. And these are rooms depicted in high-resolution stunning 3D, (most of them, by the by, being death-traps!).

You start off controlling two separate characters Head and Heels, each of which has different powers, enabling them to solve some of the maddeningly-clever puzzles which hamper your progress at every stage. Eventually you can link the two characters, Head over Heels, and advance your power to new heights.

If it's high-quality, animated, brain-stretching entertainment you're after, you won't find better.



# 8000 PLUS DUST COVERS

Just £11.95 for the complete set

Ever wondered why you see so many computers dust covers advertised? It's because computers don't like dust. Over a period of time it can make them very ill indeed: keyboards stick, disk drives become less reliable, printers smudge.

A set of dust-covers for the three parts of your system provides a neat solution. And there's the added bonus of smartening up the hardware's appearance when it's not in use.

The specially-commissioned 8000 Plus covers are made from high-quality anti-static nylon fabric. The covers themselves are a soft grey colour with those for the monitor and printer piped in red. The keyboard cover bears the 8000 Plus logo in red.

It adds up to a good argument for a cover up.



# BINDERS

Just £4.95

Here's the cure for a desk cluttered with back issues of 8000 Plus: the official 8000 Plus binder.

It's a smart, sturdy piece of kit with our logo stamped proudly on the spine. More to the point, it holds 12 copies of your favourite magazine and is guaranteed to keep them in fine condition for years to come.

Loyal readers, roll up.

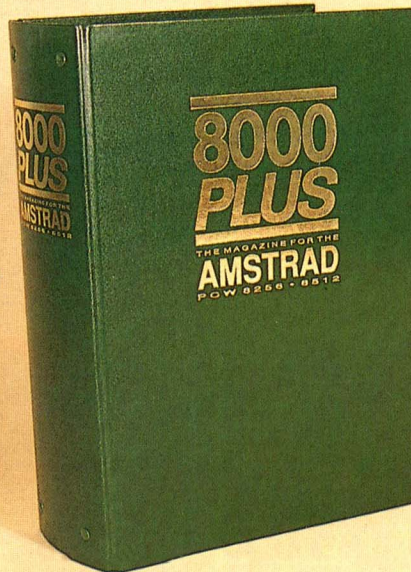

## HOW TO ORDER

Just fill in the form overleaf ▶

## SPECIAL OFFERS WANT A THINGI?

*Yours for just £5.95 – save £2!*

What's white, dangles papers next to your computer screen, and costs two pounds less than in the shops? Yes, a Thingi bought through 8000 Plus.

This remarkable computer accessory – an idea so simple it's ingenious – could dramatically ease your word-processing hours. All it is is a cleverly shaped piece of plastic that attaches via Velcro to the top of your micro. But with a Thingi on your PCW you can have documents, letters, or program listings clipped right next to the screen in perfect reading position.

Any task involving copying off paper is thereby made much easier and faster. In fact the clip supplied is sturdy enough to support an issue of 8000 Plus open, say, at the TipOffs section.

The Thingi can be positioned either to the left or right of the screen and can easily be removed and replaced if necessary.

A really sensible, cost-effective add-on for your PCW.

SPECIAL OFFERS  
SPECIAL OFFERS



## THE PAWN

Only £19.95 – save £5!!

This program from Rainbird Software is one of the year's outstanding releases. It's a grand adventure set in the mysterious kingdom of Kerovnia replete with ice towers, golden palaces, dangerous forests. In your battle to escape this land you encounter intriguing characters such as the laughing Buddhist monk, and must use your sharpest wits to extricate yourself from some dire situations.

Where the game excels is that it features both outstanding graphics and effective text description and interaction. The 8000 Plus reviewer awarded it five out of five across the board, so what could we do but rush out and obtain it at a discount for you our readers...? A magical purchase.

THE ORIGINAL

# EASY LABELLER



24 HOUR  
ACCESS  
ORDERING  
SERVICE

PURPOSE DESIGNED TO SOLVE ALL YOUR LABELLING NEEDS  
NO FILES - NO FUSS - VERY FAST - EASY TO USE

## PROGRAM FEATURES

- \* PRINTS SINGLE LABELS
- \* PRINTS MULTIPLE LABELS
- \* PRINTS LABELS BY CATEGORY
- \* 99 CATEGORIES
- \* DIFFERENT TYPE STYLES
- \* UP TO 1000 LABELS PER DISC
- \* ANY SIZE
- \* ANY NUMBER ACROSS THE WEB
- \* DATE STAMPING
- \* CONSECUTIVE NUMBERING
- \* LABEL CODING
- \* FULL ON SCREEN EDITING
- \* COMMAND DRIVEN
- \* FIND AND CHANGE TEXT
- \* FIND AND PRINT TEXT
- \* INSTANT ACCESS
- \* ON SCREEN HELP
- \* NEW DISC GENERATION
- \* SET MARGINS & GAPS
- \* INSTANT AUTOMATIC SORT
- \* PAUSE PRINTING BETWEEN LABELS
- \* LIST BY CATEGORY STARTING FROM ANY LABEL
- \* SCAN LABELS FOR EASY UPDATE
- \* PLAIN PAPER LISTINGS OF ANY LABEL DETAILS IN ANY ORDER STARTING FROM ANY LABEL
- \* NON PRINT INFORMATION E.G. TELEPHONE NUMBERS ALLOWED ON LABELS
- \* MULTIPLE DATA DISCS
- GIVING UNLIMITED LABELS AND SIZE
- \* TEST PRINTS
- \* TEST PATTERNS
- \* LISTS ALL NAMES & CATS.
- \* USE WITHIN 2 MINUTES
- \* + OTHERS

## FOR USE BY

- \* SHOPS
- \* CLUBS
- \* MAIL ORDER COMPANIES
- \* MANUFACTURERS
- \* WHOLESALERS
- \* PACKERS
- \* DISTRIBUTORS
- \* RETAILERS
- \* SCHOOLS
- \* CARPENTERS

AVAILABLE FOR THE  
AMSTRAD PCW 8256/8512 PC 1512  
AND OTHER IBM COMPATIBLES

## USES FOR

- \* ENVELOPES
- \* PARCELS
- \* BOTTLES
- \* FOOD
- \* ADDRESSES
- \* MAILSHOTS
- \* MANY OTHERS

## ADDRESS LABELS

89 x 36M 2000	4000	8000
Nett	9.00	17.00 32.00
Vat	1.35	2.35 4.80
Total	10.35	19.35 36.80

OTHER SIZES AVAILABLE

JUST

**£29.95** + £4.49  
VAT

POST & PACKING F.O.C  
TRADE, DISTRIBUTOR  
& EXPORT ENQUIRIES WELCOME

## COMPLIMENTARY

500 FREE LABELS WITH ALL ORDERS

SEND YOUR ORDER TODAY TO:

M.A.S.S. FREEPOST (8000MAY)

43 WYMER ST.

NORWICH

NR2 4BR

TEL: (0603) 630768

No stamp required.

PLEASE STATE  
COMPUTER TYPE

PLEASE NOTE: EASY LABELLER IS A PURPOSE DESIGNED PROGRAM AND NOT A DATA BASE ADAPTION. THE NEED TO DEAL WITH DISC FILES IS NOT REQUIRED. HUNDREDS OF SATISFIED CUSTOMERS, BOTH EXPERIENCED AND FIRST TIME USERS, HAVE FOUND EASY LABELLER INVALUABLE FOR PRODUCING MAILING LABELS, TICKETS, CONTINUOUS ENVELOPES ADDRESSING AS WELL AS QUICK AND EASY TO USE FILING SYSTEM.

## "THE VILLAGE"

HOUSE OF COMPUTERS  
THE Amstrad Specialist in Kent  
AMSTRAD PC1512/IBM COMPATIBLE  
All Models in stock NOW - Plus  
Full range of Software - Ring for details

### DISCOUNT AMSTRAD PCW SOFTWARE

	RRP	OUR PRICE		RRP	OUR PRICE
<b>SAGE</b>					
Accounts.....	89.95	89.95	Sales Ledger.....	50.00	56.95
Invoicing.....	63.95	63.95	Purchase Ledger.....	50.00	56.95
Payroll.....	63.95	63.95	Invoicing.....	50.00	56.95
Acc. + Inv.....	139.95	139.95	Nom. Ledger.....	50.00	56.95
Acc. + Inv. + Payroll.....	179.95	179.95	Stock Cont.....	50.00	56.95
Chit Chat E. Mail.....	63.95	63.95	<b>TASMAN</b>		
Chit Chat View.....	63.95	63.95	Tasword 8000.....	24.00	21.95
Chit Chat Combo.....	89.95	89.95	<b>ASP</b>		
Retrieve.....	63.95	63.95	Money Manager.....	20.00	24.95
Magic Filer.....	63.95	63.95	At Last Database Manager.....	20.00	24.95
<b>DIGITAL RESEARCH</b>			<b>CAXTON</b>		
Dr Graph.....	45.95	45.95	Touch 'n' Go.....	24.00	20.95
Dr Draw.....	45.95	45.95	Brainstorm.....	40.00	42.95
C Basic.....	45.95	45.95	Smartkey.....	40.00	42.95
Pascal.....	45.95	45.95	Scratchpad.....	50.00	59.95
<b>IANSYST</b>			Cardbox.....	50.00	49.95
Iankys.....	24.00	21.95	Condor.....	30.00	84.95
<b>ARNOR</b>			<b>NEWSTAR</b>		
Prospell.....	20.00	26.95	Newword.....	50.00	64.95
<b>PCW GAMES</b>			Cracker.....	40.00	43.95
Batman.....	14.00	12.95	<b>MAP</b>		
Bridge Player.....	10.00	17.95	Accounts.....	140.00	129.95
Cyruus II Chess.....	15.00	12.95	Payroll.....	40.00	47.95
Tomahawk.....	10.00	17.95	<b>ASHTON TATE</b>		
Jewels of Darkness.....	10.00	17.95	D Base 11.....	110.00	114.95
Annals of Rome.....	24.00	21.95	<b>AMSOF</b>		
Pawn.....	24.00	21.95	Supercalc 2.....	40.00	43.95
Trivial Pursuits.....	10.00	17.95	Locomail.....	30.00	36.95
Infocom adventures - full range stocked. Price on application			Locospell.....	30.00	36.95
<b>COMPACT</b>			<b>EDUCATION PCW</b>		
Accounts.....	190.00	179.95	French Mistress.....	10.00	16.95
Daybook.....	40.00	42.95	German Master.....	10.00	16.95
Payroll.....	30.00	84.95	Spanish Tutor.....	10.00	16.85
Nucleus.....	30.00	84.95	<b>DIGTA (formerly Gemini)</b>		
Interlacer.....	50.00	56.95	Datstore.....	30.00	34.95
			Supertype.....	20.00	24.95

### TRAINING COURSES NOW AVAILABLE

ON ALL SOFTWARE & HARDWARE. RING FOR DETAILS

Mail Order welcome. Orders over £50 carriage free, under £50 add £1.50

ACCESS & VISA WELCOME. Up to £1,000 instant credit (A.P.R. 31.3%) - Subject to status

87 Beckenham Lane, Shortlands, Bromley, Kent BR2 0DN Tel: 01-460 7122

## SOFTWARE from COPY COMM

FREE Unbiased, expert advice on all aspects of software  
FREE Unlimited telephone support for software supplied by us

We supply, at competitive prices, the vast majority of software currently available for all popular computers from our list of several thousand titles which is growing daily.

YOUR BEST BUY IS A PHONE CALL AWAY

**COPY COMM (Software Division)**  
FREEPOST Cupar Fife KY15 4BR

Telephone (0334) 56309

Telex 76284

FAX (0334) 56306

Available for the Amstrad PCW:

### SIGNWRITER: Instant Display Lettering by Computer

£49.95

- \* Signs (like this) printed across or down the page
- \* Sharp characters, any size - the bigger the better!
- \* Create your own logos, symbols, fonts

extra fonts £5.75 + disk : ROMEFONT Handfont (ZooFont)



### LABELWRITER

£15

- \* Multiple identical labels, any size, any number across
- \* Uses all the printer's type-styles
- \* Serial numbers, logos too!

### PAPERBASE De Luxe: A Computerized Personal Database for Scientists

£57.50

- \* Stores, finds, and styles references
- \* Flexible storage in portable sequential files

All available from the publisher:

**WIGHT SCIENTIFIC**

44 Roan Street, London SE10 9JT

(01) 858 2699

Also:

OXSTAT for statistics  
HISTO for histograms  
FREQ for word counts  
INDEXER

Prices incl. VAT + p&g

# POSTSCRIPT

Another bundle of bumf, borne off and bandied about by a boisterous Ed

**This month's postbag has been as lively as ever – plenty of contentious views, bouquets, pleas for help, and an occasional criticism, constructive of course. It's what you write that helps us fine-tune each issue to be even better than the last, so get writing! Try us out with your questions, problems, opinions and oddities at: *PostScript*, 8000 Plus, The Old Barn, Somerton, Somerset TA11 7PY. Sorry, but no personal replies.**

**If you are plugged in to the world of comms, you can send us your letter by Telecom Gold, using the mailbox 84:TXT152.**

## The size of the problem

As the chap responsible for public relations (ultimately), I come up against this marvellous word 'BUG' more often than I would like. With it come the whole spectrum of customers and their various degrees of reasonableness and understanding. Let me attempt to put the record straight, so that at least the readers of 8000 Plus may show a little more sympathy to ourselves and to other software houses in the future.

Any non-trivial piece of computer software is *never* perfect. In fact, if 'finished' is to imply that the program will work predictably under all circumstances, it is indeed never finished either! Many people find this concept quite unacceptable. They have some mystical vision of a computer as mathematical perfection. Somehow, like a pocket calculator, it cannot and should not ever be wrong. Well if only the real world of computing really was like that. To give you some idea of the complexity of Protext (or for that matter any piece of business software) consider the fact that there are more possible ruler lines, creatable on Protext, than there are atoms in the known universe!... and ruler lines are just one of a whole

multitude of features of a document.

Of course this is not to say that software houses do not have an obligation to make the product fit for the purposes for which it is sold, of course they do, but it is simply not possible to rout out all the niggling little 'mini-bugs' in any reasonable number of man years. In fact some little items are still coming to light in Arnor titles which must have had more than 10,000 man years of use!!

OK, so software houses are made up of people not demi-gods and all software is likely to have faults of varying degrees of nuisance. What is the answer? Well one school of thought would say that software is a work of art, much like a book, a record or a painting (in fact, the law treats it very much in that category in terms of the sale of goods act... providing it broadly speaking 'does the job', you are buying it *as is* with no recourse to the publisher). At Arnor we have too big a conscience for that, even in relation to the most minor faults.

Any version of our software with a proven bug is upgradeable free of charge to the latest version. In addition, if you simply don't like the feel of it for some reason, then we offer a seven day money-back guarantee with no questions asked (did I really refund that woman

because one word was misspelt in version 1 of the Prospell dictionary?... I'll never make it to the Bahamas at that rate).

Of course most customers understand that new software needs nursing into existence in this way, but there are always those out to prove your advertising scandalous and illegal when countless hours have been spent trying to make the product live up to the advertising in every possible way.

Oh well... enough scribe on Arnor's behalf for now, back to customer service... and would you believe the first letter I look at wants a refund because the 'calculator' isn't fully floating point... he needs a spreadsheet not a word processor, doesn't he?

Here's to a brighter month, next month.

**David Fisk  
Arnor  
Croydon**

## Moving house

I ordered a Modem, software and serial interface from Modem House a couple of months ago, and the only result was a letter saying they couldn't supply. They advertised in your December issue. Have they gone bust or what? I now have a subscription to Telecom Gold, and must find a new equipment supplier.

**Richard Tweed  
Park Hill  
Croydon**

*As far as we can establish, Modem house are still trading, although this name has been used as the trading name for at least three different companies in the last five months. Two of those are now in liquidation. We've still to be paid for their December advertisement. Draw your own conclusions.*

## Correct corrections

After buying only the last two months issues I have to say you have me 'hooked', realising also what I missed in the earlier editions. The TIPOFFS (1-6) will, I am sure, go some way to making up for the late start so send it soon!

The programs you publish (mainly from your readers) have been of great interest, however, I must say you seem to suffer - to a lesser extent than your competitors - from erroneous listings, and having spent a long time feeding them into my PCW8512 it is very frustrating when a bad error in the listing prevents them running.

Even more annoying is when one gets a program going you then publish a 'correction' the next month which causes an otherwise good program to 'crash' - I must draw your attention to the excellent Calendar program (Feb) by Thomas Sykes. The corrections that appeared on page 59 and page 79 (Mar) cause the calendar to give incorrect date/days - certainly for 1987 anyway.

**Nigel Edwards  
Tadcaster  
North Yorkshire**

*Not so. Either set of corrections will work, although, of course, the amendment to line 170 published on page 79 of the March issue only replaces the IF statement condition, and not the whole line. You may have had trouble with the backslash character (the one that goes from top left to bottom right). In Mallard BASIC this character is produced by pressing [EXTRA] 2 twice! The symbol stands for integer divide.*

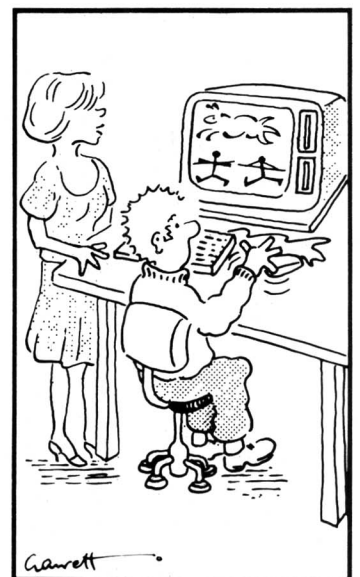

"BIT PRIMITIVE, ISN'T IT? - THAT ART PACKAGE"

## Good service awards

In the past I have always been dubious about using Mail Order facilities which are advertised in newspapers and periodicals. Especially when there have been so many cases of 'rip-offs' and non-receipt of paid for goods.

My faith in human nature has however been restored and I feel I must inform you and your readers of 3 firms that it has been a pleasure to deal with.

### Crown Dust Covers Ltd

A telephone call one morning to their office in Williton informed me that they would be pleased to dispatch to me that day, one set of luggage for my PCW 8256. When I enquired about method of payment I was politely informed that an invoice would accompany the luggage and if I could be so kind as to send them a cheque within 30 days, that would do nicely! I was speechless! This is marvellous, a trusting, cooperative firm. A pleasure to do business with. Three days later my set of luggage arrived.

### Silicon City

A few days after that experience I decided I would try this memory upgrade from Silicon City which had been quoted in 8000 Plus. I telephoned Silicon City to make a Credit Card order and spoke to a

very helpful fellow there. I explained that I knew nothing about chips, bits and so on and he very patiently explained what to do. He then said he would despatch that day, my set of chips and the instruction sheet. The following morning at 0930 hours, by recorded delivery, appeared the package as promised. After 10 minutes reading the instructions, it then took me 25 minutes to complete the upgrade from a hesitant start to a successful test run.

### Campbell Systems (Masterfile 8000)

This experience was a combination of the above two, pleasant, courteous and extremely helpful. Again a Credit Card order, but I could have been paying in gold! It did not make any difference to the firm. My Masterfile 8000 was dispatched the same day as my call and took 4 days to arrive.

Too many people have had, or read about, bad experiences when dealing with firms and I think its about time that the good firms got a mention. The only reason I contacted these particular firms was that you had covered their products in 8000 Plus.

### G M Burley Bordon Hants

*It's good to hear a few compliments in amongst the brickbats. As ever, it's only a small minority of companies which give the whole industry a bad name.*

## My kingdom for a dressing gown

I had occasion to write to you some weeks ago about *Hitchhiker's Guide to the Galaxy* and thank you for your reply.

My problem now is that, after many an unsuccessful try, I am still stuck in the room and my score sheet reads: You have scored 0 out of a possible 400 in 19 moves!

I am a complete tyro with these games but I have enlisted the help of game-crazy young acquaintances, still with no success.

### Roger J Flavell Wolverhampton

*It's all to do with how much you had to drink the previous night, and how you cope with it. See the letter from the Elf.*

## Writing companion

Having just read your review of *Companion*, I would like to make a few comments.

While the review is generally fair and factually correct it only covers half the product, the memory resident utilities. While I

accept that the non-resident utilities are slow to start by comparison with the resident utilities, this is surely not reason enough to almost completely omit them from the review.

I would like to point out some of the features that the reviewer missed. Firstly, all non-resident utilities (notepad, phonebook, diary/calendar) have WordStar style cursor movement and editing facilities as well as search for first and search for next features. They all allow the user to have multiple files so that you are not restricted to those supplied. You are able to print the contents of any page of text, a feature which is particularly useful in the phonebook as, once located, any entry may be printed directly as an address label. The diary/calendar utility provides a calendar and diary up to the year 2000 with a separate page for each day. There are many other features I could mention but I think I have made my point.

The minuses you give at the end of the review include the following 'Takes up over 3k of CP/M's workspace - might inconvenience some programs'.

The PCW has 61k of memory in which to run CP/M programs, all CP/M programs that I know expect less memory than this and are not affected when 3k of this space is used for other purposes. If you know of any CP/M program which requires so much memory that it will not work in conjunction with Companion then I would be interested to hear from you.

### Nik Sen Digital Integration Camberley

*Companion is sold heavily on the fact that it will run while other programs are in use. As such, to have to swap discs to load many of its features seems to detract from its general usefulness.*

*The easiest application to think of that Companion could 'inconvenience' is Mallard BASIC, which has less than 32K available to it before you've written a line of program. Any other language would be similarly restricted.*



*"SORRY - CAN'T GIVE YOU MY PHONE NUMBER - IT'S PROTECTED UNDER THE DATA PROTECTION ACT"*

## The HAMstrad connection

I have sent this letter to you, asking very much for your help. My hobby is Amateur Radio, it has been for many years. I have just put the AMSTRAD PCW8256 into my room, this was to help me log all past work also future work. But I am in trouble with this equipment, I have found out there are no software programs for this computer. I need someone to make me a logging program, otherwise I can't use it, for my work. I am asking you to do one for me - (if possible). If you can't

do this, do you know any one who will. I have also sent you a sheet from an Amateur log, to show you what I need.

All I want is the log on the screen, be able to fill it up, enter it onto the Disc. The screen clear, then another log comes onto the screen, ready to fill, etc. etc. This would go on until the Disc was full.

When this Disc is full I can put it in to bring back the logged sheets, one sheet, press return (or) any key, for the second sheet, etc. etc.

Well this is what I require from you (or) any one who can do this for me, I do need this program very much, and I am asking for help. You see it will only be a couple of years, before I will not be able to hold pens very well. I hope you know what I mean, this is the reason for the computer.

### J Ball Henbury Bristol

*This is an ideal job for LocoScript templates. Set up a template to represent your blank logging form, and insert a unit marker (by using the [UNIT] sequence) at every point where you'll want to enter values into the log.*

*When you want to start a new log, create a document on the group in which you defined the template and press [SHIFT][UNIT] to move to the first unit marker you defined. You can save the log to disc at any stage and reload it later. When it's full, it is a simple matter to create another log with the same template.*

## I SUBmit

Is there any way of clearing the screen from within a .SUB file? Having cleared the screen, is there any way of turning off the screen whilst files are being transferred from the A drive to the M drive? Having done that, is there any way of writing a message to the screen along the lines of 'Please wait whilst your program is loaded'?

You may be able to guess from these questions that I am far more familiar with MS-DOS than with CP/M. Is there a book that you would recommend about CP/M+ and how do I get hold of a copy?

### CF Ingrams Stamford

*You can clear the screen, and turn it off (or at least set the foreground colour to black), by typing control sequences at the A> prompt, and these codes can be incorporated into a .SUB file. Remarks can be added by preceding them with a semi-colon (;). These will appear on the screen, as long as you haven't*

# MIX C COMPILER ONLY £33.95!!

WITH 30 DAY MONEY BACK GUARANTEE!!

"Outstanding value for money... The Mix manual is superb... The beginner will find the Mix Compiler both cheaper and easier to work with."

MIX C COMPILER	£33.95	MIX EXAMPLES DISC	£5.95
MIX SPLIT SCREEN EDITOR	£25.95	COMPILER & EDITOR & ASM & EXAMPLES	
MIX ASM UTILITY	£9.95	Incredible value at only £57.95 Normally £75.80	

PCW 8256 Memory Upgrade—£16.95  
Telephone support available evening & weekends!!

Runs on all Amstrads including PC 1512 and PCW 8256/8512

Please add 15% VAT. Price includes 1st class UK postage.  
Overseas please add £3 per order.

Write or phone for our comprehensive 9 page brochure on this extraordinary product including the superb review from "Computing With The Amstrad" February 1987

Cheques payable to:

**ANALYTICAL ENGINES LTD**

PO. BOX 35, EASTLEIGH, HANTS, SO5 5WU. Tel: 0703 262099

## ££ LOOK & SAVE ££

### SPECIALIST SOFTWARE PCW

Accountants	Dentists	Doctors	Draftsman
Estate Agents	Farmers	Newsagents	Publicans
Retailers	Solicitors	Technical Authors	Video Rental

### STANDARD SOFTWARE PCW

<b>SAGE</b>	<b>CAMSOFT</b>	<b>VARIOUS</b>	<b>WORDPROCESSING</b>
Pop Accounts 69.00	Nominal 37.00	MicroSIX Accounts 79.00	Protex 59.00
Pop Accounts+ 105.00	Payroll 37.00	DR Draw 37.00	New Word 2 54.00
Pop Invoice 49.00	Stock 37.00	DR Graph 37.00	Locomail 31.00
Chit Chat Com 70.00	Invoice 37.00	At Last (DBM) 25.00	LocoSpell 31.00
Ditto w/ Modem 191.00	Combo PSIL 112.00	Toich n Go 19.00	Tasword 8000 19.00
<b>DATABASES</b>	<b>SPREADSHEETS</b>	<b>LEISURE</b>	<b>LEISURE</b>
DBase II 86.00	Supercalc 2 41.00	Cyrus 2 Chess 13.95	Bridge Player 3 17.95
Delta 1 25 74.00	Scratchpad+ 45.00	Colossus 4 Chess 17.95	Batman 12.95
Condor I 74.00	Cracker 2 39.00	3D Clock Chess 12.95	Tomahawk 14.50

### COMPUTERS

PCW8256 8512	£428.535	PC1512 SD MM 20MB HARD DISC	£975
PC1512	*CALL for 1987 PRICES	PC1512 SD CM 20MB HARD DISC	£1175

ALL PRICES INCLUDE VAT & DELIVERY

DEMONSTRATIONS, QUOTATIONS, CONSULTATION, PERSONAL EXPORT SERVICES.

KINTECH COMPUTERS, ST. TUDY, BODMIN, CORNWALL, PL30 3NH.  
Tel. 0208 850176

# re-ink your ribbon!

(For the Amstrad PCW8256/8512 & Epsom fabric printer cartridges. Other ribbons upon enquiry.)

No need to buy a new ribbon cartridge when your printer goes pale — Ring (0784 252662) or write to us and we will send you a pre-addressed stamped envelope. Put your tired ribbon cartridge in the envelope with payment and pop it in the post.

We will re-ink your ribbon like new and post it to you on the same day we receive it.

**And it only costs you £1.90.**

(That is three re-inks for the price of one new cartridge!)

## SPECIAL OFFER

One free re-inking  
with purchase of one  
Seal 'n' Type: See page 90

**KADO**  
PO Box 20  
Ashford  
Middlesex  
TW15 3QE

## THE BUSINESS CENTRE

### ACCOUNTS PACKAGES

Compact Daybook	45.00
Compact Accounts	170.00
Compact Accounts Plus	199.00
Compact Sales Ledger	59.99
Compact Purchase Ledger	59.99
Compact Nominal Ledger	59.99
Compact Nom. Led. Reporting	44.95
Compact Stock Control	59.99
Camsoft Accounts SIS	84.00
Camsoft Accounts SPIN	84.00
Camsoft Accounts SISPN	114.00
Sage Popular	75.00
Sage Popular Plus	114.50
Map Integrated Acts	125.00

### PAYROLL

Compact	89.95
Camsoft	43.95
Sage	54.00

### LEISURE SOFTWARE

Colussus 4 Chess	17.00
Tomahawk	17.00
Trivial Pursuit	19.00
Scrabble	18.00
Strike Force Harrier	18.00
The Pawn	22.00
Silicon Dream	18.00
Classic Collection	12.00
3D Cyrus II Chess	18.00
After Shock	15.95
Annals of Rome	22.95
Batman	14.95
Black Star	14.95
G. Gooch Test Cricket	17.95
Lord of the Rings	22.95
Monsters of Murdac	17.95
SAS Raid	14.50

### PCW BOOKS

Amstrad CP/M Plus	12.95
Mastering the Amstrad PCW	8.95
Step by Step Guide to Locoscript	4.95
Using the PCW 8256	9.95
Program your PCW	6.95
CP/M Bible	16.50
CP/M Plus Handbook	13.95
GSX Handbook	19.95
Starting Logo	6.95
Advanced Amstrad Basic	12.95
Amstrad Mallard Companion	7.95
Program your PCW	6.95
Understanding dBase II	22.95
dBase Prog. Language	14.95
dBase II for the first user	16.95
Soul of CP/M	16.50
Using CP/M	5.95
Mastering CP/M	17.95
Intro to CP/M Plus	7.95
Practical Logo	6.95

### SPREADSHEETS

Supercalc 2	41.95
Cracker II	41.95
Scratchpad Plus	49.50
Pocket Calcstar	34.95

### DATABASES

dBase II	89.00
Cambase	39.50
Cardbox	47.00
Sage Retrieve	54.00
Locomail	37.00
Pocket Datastar	35.00
Condor I	89.95
Pocket Matchbox	29.95
Dataflow Mailflow	39.00

### PCW HARDWARE

Thing	5.95
Electric Studio Lightpen	64.00
Electric Studio Mouse	114.00
Electric Studio Digitiser	92.00
Graph PAD3	139.00
Joystick Controller	22.50
FD2 Second Disc Drive	149.00
FD2 & Memory Upgrade	170.00
8256 Memory Upgrade	29.95
RS232/Centronics Upgrade	57.00
V21/V23 Amstrad Modem	95.00
2 PCW Printer Ribbons	9.95
Lockable 3 Disc Storage	11.00
10 Mb Hard Disk	499.00

### COMPUTERS

PCW 8256 with free discs	440.00
PCW 8512 with 5 free discs	555.00
CPC 464 Green	179.95
CPC 464 Colour	279.95
CPC 6128 Green	279.95
CPC 6128 Colour	369.95

### PRINTERS

MP 165	239.00
CPA80	189.00
MP 200	325.00
MP 201	410.00
Panasonic P1080	179.00
DMP 2000	159.00
DMP 3000	179.00
DMP 4000	399.00
Star NL10	259.00
Juki 6000 Daisy wheel	199.00
Juki 6100 Daisy wheel	299.00
EPSON LX86	270.00
CITIZEN 120D	199.00

### WORD PROCESSING

Protex	74.00
Prospell	24.00
Pocket Wordstar	37.00
Tasword 8000	19.50
Tasprint 8000	12.50
Taspell 8000	14.50
Locospell	37.00
Newword	62.10
Tasword and Tasprint	79.95

### GENERAL & UTILITIES

DR Draw	39.50
DR Pascal	39.50
DR C Basic	39.50
Pagemaker	45.00
Fleet Street Publisher	64.50
White Hand Man	25.00
Smartkey	39.95
Brainstorm	39.95
Rotate	22.95

### EDUCATIONAL

Touch 'n' Go	19.50
Locoscript Tutorial	8.95
Ian Key Typing Course	22.95
Hands on CP/M Plus	19.95
Hands on Supercalc	19.95
Hands on dBase II	19.95
Teach Yourself Locoscript	14.95

### MODEMS

Amstrad V21/V23	99.00
Miracle WS2000	120.00
WS3000 V21/V22/Hayes	330.00
WS3000 V21/V22/V23	550.00
WS3000 V21B15/V22/V23	699.00
Quattro	795.00

• AMSTRAD PC 1512's NOW IN STOCK • PHONE FOR LATEST PRICES • ALL SINGLE & DUAL DRIVE SYSTEMS AT PRE-INCREASE PRICES WHILST STOCKS LAST

## Comtec Systems

58a Wellingborough Road Northampton NN1 4DN Tel: (0604) 24463

ALL PRICES INCLUDE VAT & POST & PACKING TO UK

- We are fully authorised Amstrad Repair Centre, with 'in-house' repair facilities.
- Phone now for details of our service contracts and repair costs.
- County Council, Local and Education Authorities. Orders Welcome.
- Corporate and Export Orders welcome.

### OVERSEAS ORDERS

Please add the following to your order and make all payments in Sterling.

Software, Books, Discs, Leads	£2.00
Printers, Disc Drives	£20.00
Computers	£40.00

Please send me the following items:

Qty Product Price (inc VAT)

\_\_\_\_\_

\_\_\_\_\_

\_\_\_\_\_

\_\_\_\_\_

M/C TYPE  1512  6128  8512 TOTAL \_\_\_\_\_

Name Mr/Mrs/Miss \_\_\_\_\_

Address \_\_\_\_\_

\_\_\_\_\_

Postcode \_\_\_\_\_ Tel. No. \_\_\_\_\_

I enclose (please tick)  cheque/p.o. or, please debit to my

Access  Visa Card EXPIRY DATE \_\_\_\_\_

\_\_\_\_\_

\_\_\_\_\_

Send to: FREEPOST

**Comtec Systems**

NORTHAMPTON NN1 4BR. Tel: (0604) 24463

# POSTSCRIPT

turned it off, of course. The codes you need are:

EXIT E - clears screen  
EXIT H - home cursor

It's easiest to use PIP to create such a submit file, as it will allow you to enter the EXIT codes directly. If you want to avoid CP/M's '?' response to these unfamiliar commands, put them all in a small text file, and TYPE that text file from within the submit file.

I still haven't read more comprehensive books on CP/M than CP/M The Software Bus and The Amstrad CP/M, both by Andrew Clarke and David Powys-Lybbe. Neither is particularly accessible to the first time user, though (which doesn't include you, by the sound of it).

## Absolute boulder

I recently purchased the brilliant game, Boulder by Gremlin Graphics. I can get to the second screen with no problem but always die halfway through it. I am getting very frustrated, because it says in the scrolling messages at the bottom of the screen, after telling you what the control keys are, "THERE IS A CHEAT MODE" and I have tried pressing all sorts of keys on the keyboard and I can't find this cheat mode. Please could you tell me what this cheat mode is and I'm sure many 'Boulder' fans would be very happy and relieved.

**Andrew English**  
Nuneaton  
Warks

The answer to this one has been kindly supplied by Y. Unterman, from Cheadle in Cheshire. All(?) you have to do is press the keys Q,W,E,R,T,Y,A,S,D,F,G,H,Z,X,C,V,B,N simultaneously. From then on, as Y says - Eh-hem - 'you will never lose your balls when you really should'. And it does work, though you have to have big hands.

## The NewWord flasher

There are always two sides to every argument and I was fascinated to read Peter Philippon's letter 'In praise of WordStar'. I too have tried NewWord but in contrast, despite its many advantages I cannot get to like it. Ironically the thing which annoys me the most is that the cursor does not flash. Whenever I try NewWord I can never find where I am in the document. Strange, it just goes to show that one man's meat can be another man's poison.

One final point that perhaps you could help me with regarding my favourite software, LocoScript. I

## First with the news

I wish to make a very strong protest about your sales policy. I admit that you are by no means the only culprits, but I have to start with a magazine that I read. It is probably sheer lack of thought, never the less you are guilty of extreme bad manners, back stabbing, and virtual theft. Besides speeding the loss of another traditional British Institution.

Six months ago you released your first issue, through newsagents, and you continue to do so. May I ask you why we newsagents should bother to stock your magazine? You never asked us if we wanted it. Now you have the audacity to speak on our behalf. Page 5 of this month's issue has a banner across the page "Give your newsagent a break - subscribe". Later on you offer incentives of free or cheaper goods for being a subscriber. You don't bother to mention that the newsagent, who put you on the map, will lose his profit each time

often find when typing a list in the middle of the page that despite being lined up on the screen, when printed out the start of the line will be one or more characters out. The supplier of my Amstrads, I have one at home and one at work, are no help but there must be an answer somewhere!

Thanks for a great magazine, keep it up.

**Bernard Chater**  
Leek  
Staffs

Peter Philippon's letter headed 'In praise of WordStar' is not only likely to start a long and intense controversy but possibly even civil war!

I agreed with every word of David Langford's article and rushed round the office showing it to everyone who would look at it as final proof that my lack of success with WordStar was not the fault of the operator. If anything, he didn't go far enough in his condemnation of this intensely frustrating package.

Whether one uses the E-S-D-X diamond or the arrows keys to move about the screen, one cannot move directly vertically up and down it. The cursor will position itself at the beginning of a line or the end of a paragraph or anywhere but the place immediately above or below its current position. In non-document mode, the frequency with which one has to reform a document which has galloped off the edge of the screen has only one redeeming feature - one rapidly learns

someone decides to subscribe. That eventually, in the not too distant future, it won't be worth stocking magazines or newspapers. You don't point out that newsagents don't go on strike, as do printers and postmen. You ignore the fact that at less cost than your postage and packing the newsagent will also deliver to their door.

I will consult you. Would you consider it reasonable to put a proposal before the next national conference of the Newsagents Federation to the effect that all members should cease to stock any magazine that in any way advertises the reduction of the newsagents business? Your answer should be most interesting. Not only to the newsagents who support you but also to the general public who are already losing newsagents shops and will continue to do so in ever increasing numbers.

Is there any possibility that you will dare to publish this letter or

'Control B' if nothing else.

Frankly, I can find nothing good to say about WordStar and as for using it on my Amstrad - Well, words fail me.

**Mrs A J Wilkinson**  
Ashford  
Kent

The flashing/non-flashing cursor argument has been raging for nearly as long as word processors have been on the go. Those against have quoted the increased incidence of epileptic attacks as one reason for refusing to use programs with the flashing variety.

The 'let's go back to the left-hand margin' problem is not quite as bad as Mrs Wilkinson makes out. The cursor will travel directly up or down the screen through text, only moving left if the end of the line is to the left of the current cursor position. If you're trying to add text to the end of a paragraph, this is exactly what you want.

## Partial theft

I can't write this letter on my PCW8512 because a walk-in office thief stole my printer. Amstrad won't sell a printer on its own, so my PCW is completely useless to me.

Does anyone have a spare printer? (No questions asked!).

And to the thief - may all your data discs lose their address marks permanently.

**Miss JA Barrie**  
London SW9

Presumably the thief has a spare

should I pay to have it published as an advert?

**Roger L Paton**  
Leeds

While I will admit that the banner was ill-mannered, I think you rather over-stress your case. It is certainly true that most copies of 8000 Plus are distributed via newsagents, but we do pay heavily for this distribution, and naturally wish to increase our subscriptions as direct mailing of magazines is far more economical.

Your assertion that it's only newsagents which keep magazines in business works both ways. Without the thousands of titles published regularly in the UK, there would be very little for newsagents to sell. I imagine 8000 Plus will continue to be sold by both methods, and I think it's hard to blame us for wanting to swing the balance in our economic favour.

printer (perhaps he had his nicked). Why else should he leave the rest of the PCW?

## Random query

Is there any way to make the PCW turn out better random numbers? I have had a number of computers over the years and all but Joyce have been able to turn out at least reasonable random numbers. But the PCW!!!

**Mr B J Ford**  
Redruth, Cornwall

The random number generator used by Mallard is no worse than most, but you can seed it with one of 60 numbers from the system clock with the command RANDOMIZE PEEK(64504!).

This stops the chain of numbers repeating every time you run the program.

## On no account

I would like to comment on your Good Software File in which you reviewed Camsoft PSIL accounts software. Having purchased this and discovered the severe drawbacks associated with the application of V.A.T. to invoices, I feel this should be made known to other prospective purchasers.

Firstly if you sell goods or services with differing VAT rates (currently 0% and 15%) this system will not cope, as you cannot mix VAT rates on the same invoice. Secondly if you export and sell in the U.K., again the invoicing

system cannot cope as you cannot have two rates on the same item.

Another problem with this system is that you have to have different supplier reference numbers between the Stock Control module and the Purchase module.

Any advice you or your readers can give particularly in overcoming the VAT problems would be appreciated.

**GI Kinnaird**  
**Alice's Shop Products Ltd**  
**Oxford**

*Cambrian software say that their PSIL accounts software has offered multi-rate VAT on invoices for a considerable time, and that it is possible to use the same supplier reference numbers between modules. They can only imagine that you have a very old version of the software. If you contact them, you should be able to arrange an upgrade.*

## Colossal problems?

This may sound stupid, but I have various adventure games both for my PCW8512 and my CPC6128 and I am useless at them. I never know what to tell the computer to do apart from NORTH, SOUTH, etc. I type help and usually get 'I CAN'T HELP AT THIS POINT' or something like it, the instructions with the games go into no great detail, and I am fed up with it. Sometimes I stumble over things and manage to pick them up and that's as far as I get. The arcade games I have no trouble with as I can see what to do. Have you any ideas which would help me?

**Alison Wibon**  
**Stanley Common**  
**Derbys**

*Adventures definitely have a particular kind of mind. They're often good at mathematical problems, and nearly always good at logic and 'lateral' thinking. You really have to get hooked on one and appreciate the mind of the person who developed the puzzles, before you can start solving them. If you're still stuck, read on...*

I am writing in reply to the letter published in issue six of 8000 Plus from Mac Daley of Oxford. To get through the catacombs in *Leather Goddesses of Phobos* he should follow the instructions given by the Professor in the comic accompanying the game. These are 'clap your hands at least once every five minutes', 'hop once every nine minutes' and 'say KWEEPA every eleven minutes'. It is then a simple matter of following the map, being careful not to get lost due to some

tunnels having caved in since the map was drawn!

Mac and your other readers may be interested to know that I run an adventure help club. To join simply send an s.a.e. to me and in return I will send you some more information and a clue sheet consisting of hints for all the popular programs. Members also get a free Adventure telephone hotline, a newsletter each month and the promise that the Elf always delivers. Membership is free so there is nothing to lose.

**The Elf**  
**26 The Gap**  
**Marcham**  
**Abingdon**  
**Oxon OX13 6NJ**

*Add to that list of what adventurers are 'They are also extremely philanthropic souls'.*

## Loco review

Your review of Anglo Computer's Loco Print was quite enthusiastic so, having trust in your judgement, I immediately bought this utility over the phone. What a let down. Apart from crashing after a (☐ BOLD) it did not do what I wanted.

I use Proportional Spacing on my JUKI 6100. For the start of tabular work I wish to go out of PS into 12cpi; then for normal work back to PS - hopeless.

I returned it all to Anglo Computing asking them for a refund. I have not yet heard from them. I am going to hound then until I get it.

Please could you ensure that your reviewers conduct tests on a rather less superficial level both to keep your reputation and to save your readers' nerves.

**Adam Hardiman**  
**Main Consultants Ltd**  
**London**

*It was clearly stated in the review of Loco Print that there were problems with Proportional Spacing, particularly when trying to right-justify or centre text.*

*The software didn't crash at any time during the period of the review, so there was no way we could have reported it.*

## Which guide

Having struggled with Basic from Book 2, PCW8256/8512, Third Edition 1986 (Cost £9.95), I latched on to W H Black's letter in you March issue, 'Which guide'. After telephoning Amsoft for confirmation, I sent off my cheque for £5 with my order for a copy of *Guide to Mallard BASIC* and waited.

Lo and behold, today I have received, what? - Book 2 PCW8256, 1985 Edition (Two editions earlier than the one I already have). Presumably it's the one I should have received with my PCW8512 if they had not decided to leave it out to save money. So, I now have two copies of Book 2, but still no copy of *Guide to Mallard BASIC*.

Please, how can I get a copy of *Guide to Mallard BASIC* if it is not the same thing as *Book 2, BASIC Manual*? Your editorial comment to Mr Black's letter indicated that there are two different books.

**Peter Stapleford**  
**Cockwood**  
**Devon**

*When we published the reply to Mr Black, we too believed there were two distinct books on the subject, being sold at different prices. It now appears, however, that both are basically (sic) the same, though Locomotive's has been updated since the PCW launch, while Amstrad's hasn't. Sorry if we've created any confusion.*

## A plea for Fairlight

My dad says that if I can solve the excellent game 'Fairlight', I can get the game of my choice (which is

'Hitchhikers Guide To The Galaxy'.)

Therefore I would hope that you would be kind enough to put an advertisement in your brilliant magazine to find someone who is in the same position as me so that we can help each other to solve the game.

**Callum Sinclair**  
**51 Ballater Drive**  
**Paisley PA2 7SH**

*Fine, but who gets to keep Hitchhikers?*

## New clock program

Am I being naive in thinking that computers are meant to enhance our lives and work for us, not vice versa?

After LOGO CLOCK comes LOGO CLOCK 2 which, wait for it, has an hour hand that moves and is accurate to 30 seconds in two hours and can function as a stop watch (albeit a large one).

Can I suggest LOGO CLOCK 3?  
 10 GO TO SHOP  
 20 BUY CHEAP WATCH  
 30 PUT WATCH ON WRIST

Sorry about the syntax!

**S Beetlestone**  
**Maidenhead**

*Some people would say you've missed the point. It's not the result that's most of interest, but how you can coax Logo to produce it.*

## Words and logos

I am a mature student at the local Polytechnic, with several essays to write per term, all of which are supposed to be 2000-2500 words in length, so you can appreciate what a difference a word-count would make to me.

Incidentally I am studying computers and children as part of my course and have been playing

with Dr. Logo. Do you know of any reason why the command 'towards [n m]', when supplied with coordinates does not turn the turtle towards those coordinates, as it is supposed to, but instead prints a number on the text screen?

**Chris Newton**  
**Barking**  
**Essex**

You only have to ask: **WORD COUNTER**

```
10 INPUT "File name";file$
20 OPEN "I",1,file$
30 PRINT
40 word%=0: line%=0
50 WHILE NOT EOF(1)
60 inword%=0: line%=line%+1
70 LINE INPUT #1,line$
80 PRINT CHR$(13);"Line";line%;
90 FOR i=1 TO LEN(line$)
100 c$=MID$(line$,i,1)
110 IF c$=" " AND inword% THEN word%=word%+1:
    inword%=0
120 IF c$<>" " THEN inword%=-1
130 NEXT i
140 IF inword% THEN word%=word%+1
150 WEND
160 PRINT: PRINT
170 PRINT word%;" words counted in ";file$
180 CLOSE
```

*We've no idea why 'towards' doesn't work, and can only assume that the PCW version of DR Logo doesn't implement it properly.*

## ADVERTISER'S INDEX

AMS	IFC	Kintech	87
ASD Engineering	43	Lazahold	51
Advance Software	75	Locomotive	37
Advantage	68	MDP Ltd	26
Analytical Engines	87	Margin Maker	90
Ansible	26	Mass	84
Arnor	4,39	Meridian	68
BBD Dust Covers	26	Metroheath	43
Campbell Systems	48	Microkit	33
Capitol	77	Microplus	90
Chromodynamics	33	Minerva	66
Compumart	IBC	Mirrorsoft	41
Comtec	87	Nabitchi	21
Connect Systems	66	Newstar	9
Copycomm	84	Ocean	57
Crown Dust Covers	71	P & H Electronics	64
Cwmbran	52	RSC	62
Desktop	66	Richman	25
Digita	33	Rugby Micro Spares	52
Digital Integration	53	64 Software Centre	27
EG Computers	68	SBS Data	22
Electric Studio	15	S C Coleman	33
Euromark	71	Saxon	64
HSV	16	Silicon City	64
Hewson	58	Softsel	OBC
Hisoft	74	Spectravideo	44
IQ	52	Suffolk Software	30
Janicen	90	Vidix	77
Juken	90	Wight Scientific	84
Kado	87,90		

## DO YOU OWN A PCW AND REGULARLY READ ... ... THIS OR OTHER PCW MAGS? THEN YOU NEED: PCWINDEX

At last there is a comprehensive, monthly updated index for your PCW magazines.

### FOR ONLY £6 (introductory offer) you get...

- ★ ASCII text and data files forming
- ★ a detailed index to this magazine on
- ★ a 3" disc (Drive A or Drive B) with
- ★ extensive 11 page A4 user guide and
- ★ all updates/upgrades for only £1.50

### Or why don't you...

- ★ send a large SAE for full information with details of other magazine indexes
- ★ buy a special disc for only £7.50 if your own Database Manager (AtLast)

make your SAE/cheques/postal orders out to:

**JUKEN ENTERPRISES**

4 Bassett Wood Drive, Southampton, S02 3PT

## Speed up your Amstrad

and make it easier and more comfortable to use with 'Jani', a simple-to-fit improvement that gives you a typewriter-like keyboard. No screws – no drills – no fuss.

Send your cheque for **£3.50**  
(includes postage and packing) to:

**Janicen Products (8K)**  
18 Davies Avenue  
Leeds LS8 1JY

Lucky for your keyboard,  
the "yoke's" on us!

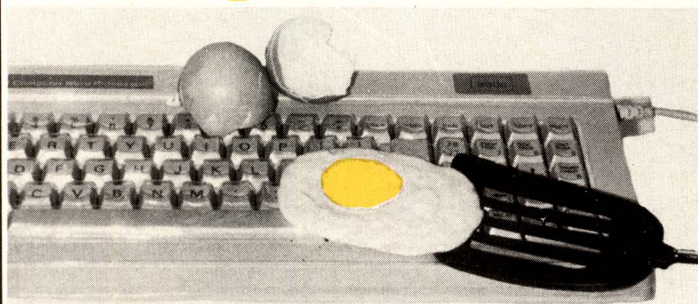

### SEAL'nTYPE

A protective keyboard cover through which you can type freely and easily.

### SEAL'nTYPE

Accidents can happen! Protect against spills, dust, ash and grime, any of which could ruin your keyboard. You can also stop erosion of your key lettering. This unique keyboard cover is made of clear, flexible plastic moulded to fit over each and every key.

### SEAL'nTYPE

Re-moveable, Washable, Re-usable.

### SEAL'nTYPE

FOR AMSTRAD MODELS:  
PCW & PC  
8512 & 1512  
8256

Patent and Registered  
Design pending

### SEAL'nTYPE Only £7.50

(plus £1.25 p&p)

Cheques payable to  
**KADO**

Send to:

**KADO**  
PO Box 20 Ashford  
Middlesex  
TW15 3QE

**kado**

Kador Ltd is  
trading as Kado

## NEW for PCW!



SINGLE  
SHEET  
ALIGNER



'MARGIN MAKER MkII'

Fed up with skew margins?

Wasting time and paper?

'MARGIN MAKER MkII' ON YOUR PRINTER WILL GIVE YOU:

Perfectly aligned printed text & Chosen Header & Footer margins. Any Left margin or paper size. No guesswork. Time & paper savings. Pitch scales 17 15 12 10 aligned to screen. Pencil mark chosen settings. Arms slide then lock. Supports printed sheet. Matches & just dips to PCW printer. Very effective Architect Designed product.

MAKE PRINTING EASIER with a 'MARGIN MAKER MkII' its the COMPLETE answer. Send a self addressed label in BLOCK CAPITALS please, & a Cheque, PO or Money Order payable to:

**MARGIN MAKER',**

Box. 121 Gresham Rd, Staines, Middx. TW18 2AJ, England

**£14.95**

incl. VAT & p+p

(Overseas, Sterling £15.95)

## PCW 8256/8512 ONLY

CASHBOOK ANALYSIS SYSTEM FOR ALL BUSINESSES — SHOP  
KEEPERS, BUILDERS, SELF EMPLOYED ETC.

Simple to use with comprehensive reports.

Analysis print out and totals.

Trial balance with expense percentages.

Supplier totals and unpaid bills.

Full facility demo version **£6.95 inc VAT P&P**

Operational version **£39.95 inc VAT P&P**

State VAT or NON-VAT version

We also supply PCW computers with on-site maintenance contract



**MICRO-PLUS**

92 CRANSTON AVE  
BEXHILL-ON-SEA  
EAST SUSSEX  
TN39 3NL

Tel: (0424) 224355

**YOU NEED A GOOD SENSE OF HUMOUR  
TO BUY FROM COMPUMART...**

**WITH OUR LOW PRICES YOU'LL BE LAUGHING  
ALL THE WAY TO THE BANK!**

**NEW  
Low Prices!**

**BOX CLEVER!**

**BRAND NEW... Specially designed  
for Amsoft  
3"CF2  
Disks**

**Holds 20-3"  
Disks & Cases**

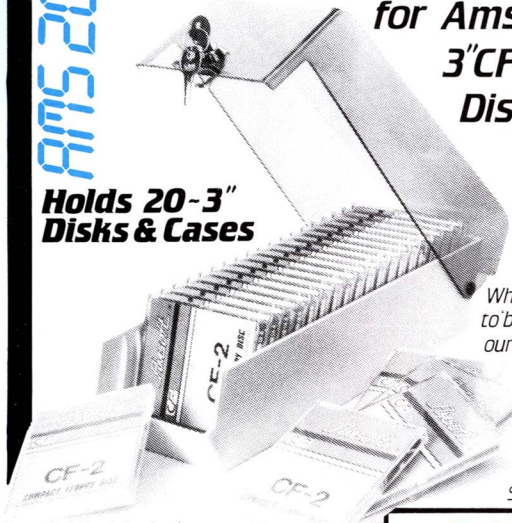

When it comes  
to 'boxing' you'll find  
ours a **KNOCKOUT!**  
Excellent quality  
Perspex, lockable.

Save on Accidental  
Damage from  
Spilt Drinks-Dust, etc.

**ONLY  
£9.95  
Post Free!**

**Amsoft  
3" CF2  
MICRODISKS**

From the U.K.'s **LARGEST** Supplier

Individually packed in  
Plastic Cases - Boxed in  
5's or 10's

**ONLY 5-£14.95** **ONLY 10-£26.95**  
PACK +£1 p&p / PACK +£1 p&p  
**SAVE £3**

Phone for Quantity Discounts



**New From AMSOFT  
'LOCOMAIL'**

For PCW Machines  
Latest version of Locoscript  
with Superb Mailmerge Facility

**Special Software Offer!**  
**ONLY £39** **POST FREE**

Buy Now & get  
2 Blank Disks FREE

**Printer Ribbons  
for  
PCW-8512/8256  
DMP-2000/3000**

**ONLY... £4.95 each**  
**post Free!**

Please specify printer when ordering

ALL Products are covered  
by the Compumart Guarantee!

**How to Order...**

Simply post your order stating:  
Name and Full Address, with  
either a Cheque or Postal Order  
(Made payable to Compumart)  
to the address opposite.

Phone any of our 3 Order Lines  
(24 Hours) and place your order  
using your Credit Card.

All Disks are usually  
despatched **SAME DAY** by First  
Class Post.

For a **SPEEDY NEXT DAY**  
Securicor Delivery, just add £2  
to Postage (e.g. £3 p&p, add  
£2... Send £5)

Overseas Orders: Please  
deduct 15% (VAT), then add  
10% (for Air Mail and Insurance).

We accept Official Purchase  
Orders from Government and  
Educational Establishments.

**COMPUMART**

**A GREAT DEAL MORE - FOR A GOOD DEAL LESS!**

**3 ORDER LINES  
(OPEN FOR 24 HOURS)**  
☎ ☎ ☎ ☎ **262259**  
**(0509) 233893**  
**266322**

Please Send Cheques/P.O.'s to...

**COMPUMART - Dept 8000 + Unit 8 - Falcon Street  
Loughborough - Leics - LE11 1EH**

ALL PRICES INC. VAT AT 15%  
PRICES and DELIVERY SUBJECT TO AVAILABILITY



# To boldly drink where no man has drunk before.

If you've ever been served with a cup of tea that resembles canal water. Or begrudgingly sipped a brew with as much taste as a gold lamé string vest, you should be able to sympathize with Arthur Dent.

Star of Infocom's™ hilarious new software extravaganza. The Hitchhiker's Guide to the Galaxy.™

Now programmed for use on the AMSTRAD and a host of other machines "Hitchhikers" gives you the chance to slip into Arthur Dent's shoes and scour the length and breadth of the universe for a decent cuppa.

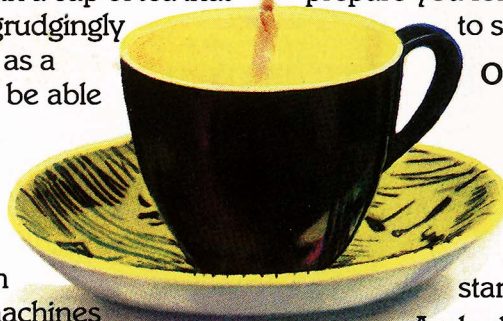

prepare you for a few dangers that are a little harder to swallow.

## ONE LUMP OR TWO

A journey throughout the universe can be a pretty nervewracking business. Especially when there's a whole host of perilous flying saucers, black holes and burning stars to deal with.

And when the Ravenous Buggblatter Beast of Traal asks "Would you like one lump or two?" He's not referring to sugar!

If you sense trouble is brewing you can just zap into another solar system and continue your voyage. But don't forget your towel.

The Hitchhiker's Guide to the Galaxy is available on Earth from your local Softsel dealer. Along with over 2,600 other titles from over 250 publishers.

So don't just sit there stewing — Go and cause a stir in the galaxy.

The Hitchhiker's Guide to the Galaxy — It's out of this world.

## DON'T PANIC

Gulp with excitement when your planet is demolished by ruthless galactic hyper-space planners.

And split your sides as your home is bulldozed by the local council. You'll laugh so much, it'll bring the house down.

Whatever happens (and just about anything can) DON'T PANIC! For all this will

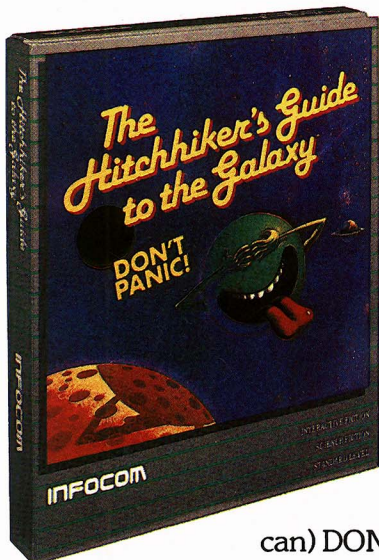

**SOFTSEL**®

Exclusive distributor of

INFOCOM™

'CLASSICS'

Softsel Computer Products Ltd, Softsel House, Syon Gate Way, Great West Road, Brentford, Middlesex TW8 9DD.